

# ASSEMBLY INSTRUCTIONS

Item No : WF292011/12

Description : STORAGE BED

Thank you for purchasing this quality product. Be sure to check all packing material carefully for small part that may have come loose inside the carton during shipment.

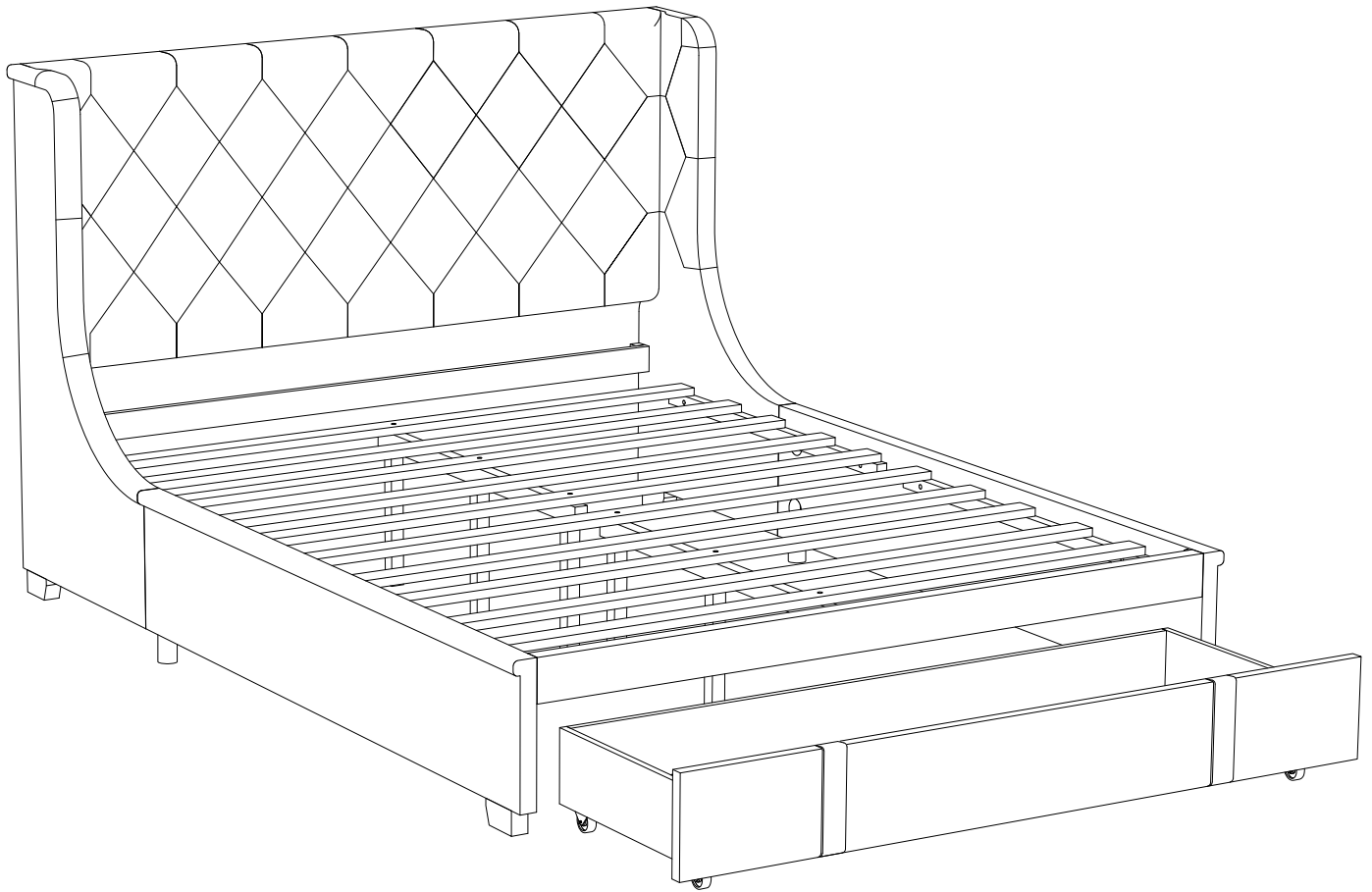

# ASSEMBLY INSTRUCTIONS

Item No : WF292011/12

Description : STORAGE BED

Thank you for purchasing this quality product. Be sure to check all packing material carefully for small part that may have come loose inside the carton during shipment.

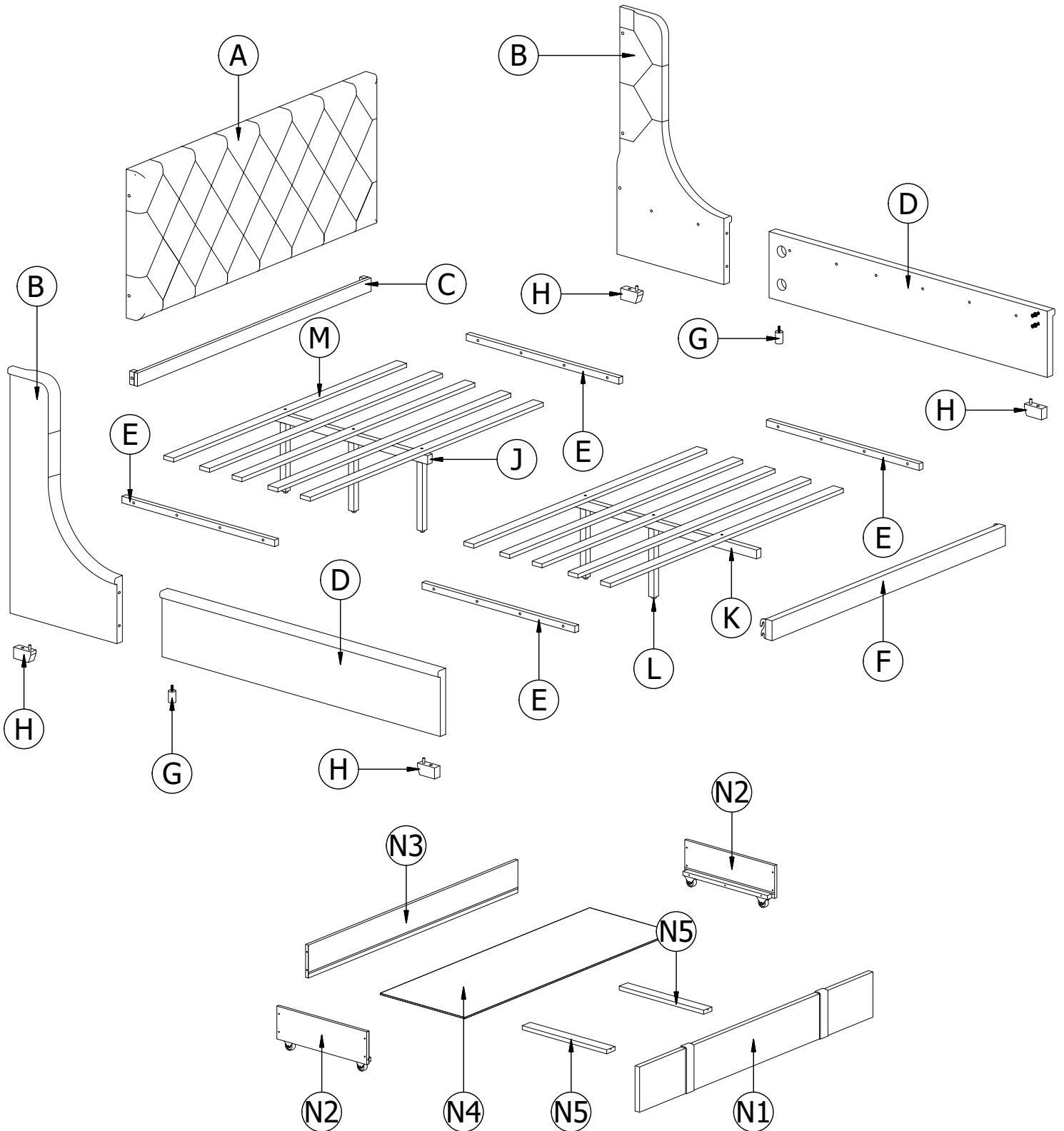











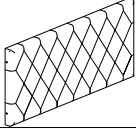

# ASSEMBLY INSTRUCTIONS

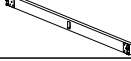
**Item No : WF292011/12**

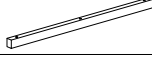
**Description : STORAGE BED**

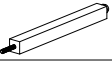
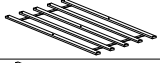
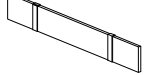
Thank you for purchasing this quality product. Be sure to check all packing material carefully for small part that may have come loose inside the carton during shipment.



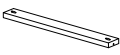







### PART LIST :

No.	Description	Sketch	Quantity
A	Headboard panel		1PC
B	Wing HB L/R		2PCS
C	Stretch		1PC
D	Side Rail L/R		2PCS
E	Support Rail		4PCS
F	Footboard		1PC
G	Bun Foot Round		2PCS
H	Bun Foot Square		4PCS
J	Short Center Support Slats		1PC
K	Long Center Support Slats		1PC
L	Support Leg		5PCS
M	Slats Rolls		2SET
N1	Drawer Front		1PC
N2	Drawer Side		2PCS
N3	Drawer Back		1PC
N4	Drawer Bottom		1PC
N5	Support Bottom		2PCS

### TOOLS REQUIRED (Not provided)



### HARDWARE LIST :

No.	Description	Sketch	Size	Quantity
P	Screw		Ø 8*2-¼"L	8PCS
Q	Bolt		Ø 5/16"*2"L	23PCS
R	Spring Washer		Ø 5/16"	27PCS
S	Flat Washer		Ø 5/16"	27PCS
T	Thread Bolt	 → ← 13mmL	Ø 5/16"*2-¼"L	4PCS
U	Thread Bolt	 → ← 25mmL	Ø 5/16"*3-½"L	4PCS
V	Washer Semicircle		Ø 5/16"*25L	4PCS
W	Hexagonal Nut		Ø 5/16"	8PCS
X	Open Wrench		M12	1PC
Y	Allen Key		M4*2-½"L	1PC
Z	Screw		Ø 8*1-¼"L	24PCS

# ASSEMBLY INSTRUCTIONS

Item No : WF292011/12

Description : STORAGE BED

Thank you for purchasing this quality product. Be sure to check all packing material carefully for small part that may have come loose inside the carton during shipment.

Step 1. Assemble the Bun Foot Round(G) with the Side Rail L/R(D) into pre-drilled holes on the bottom of Rail. Please avoid overtightening.

Next, put the Bun Foot Square(H) bottom of Rail and Wing Headboard L/R, the by using the Bolt(Q), Spring Washer(R), Flat Washer(S) and Allen Key(Y). Besides, use the Thread Bolt(T) and (U), put onto pre-drilled holes Wing Headboard L/R and secure by hand.

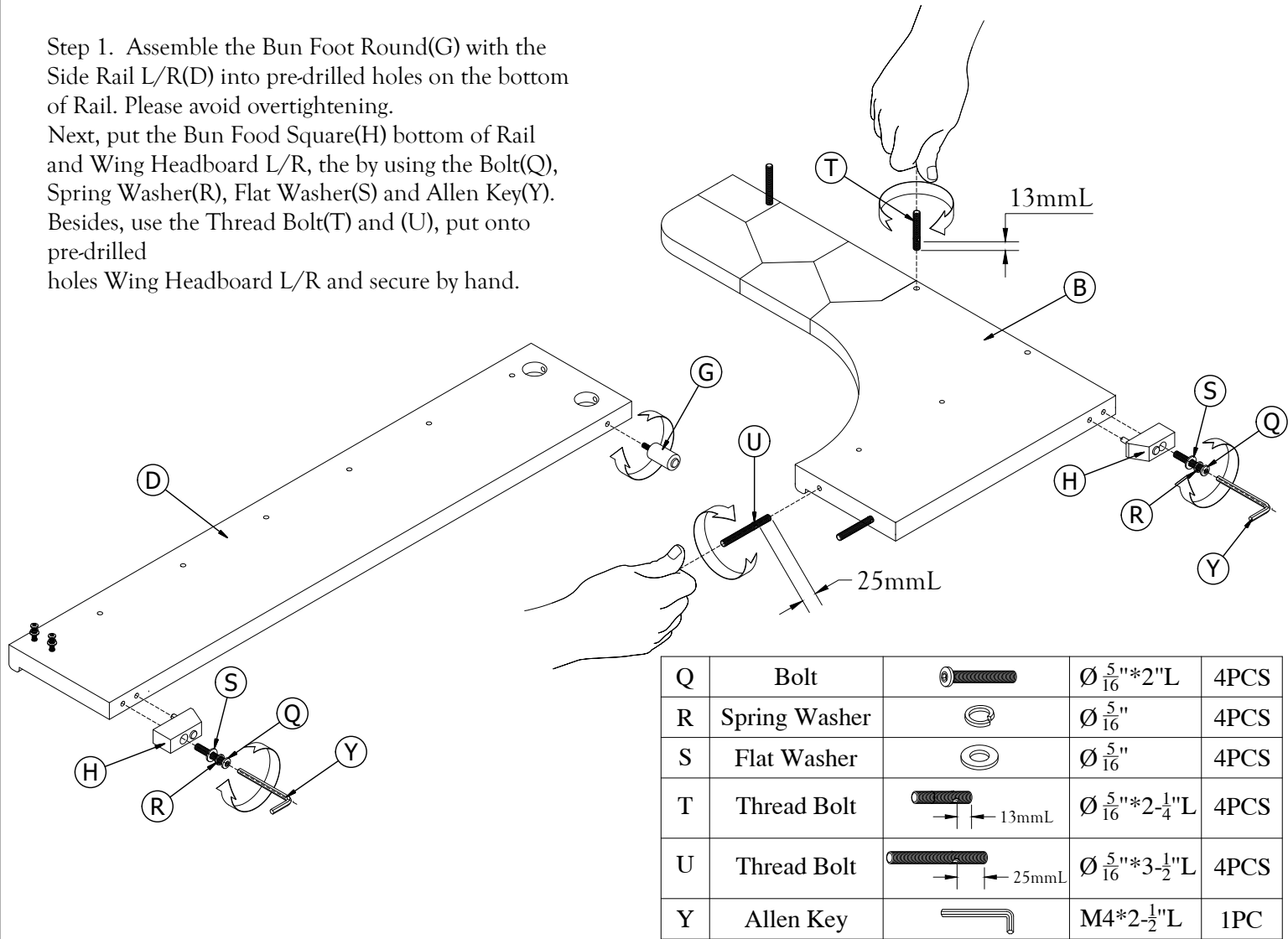

Step 2. Assemble the Wing Headboard L/R(B) together with Side Rail L/R(D) by using the Washer Semicircle(V), Hex Nut(W) and Open Wrench(X).

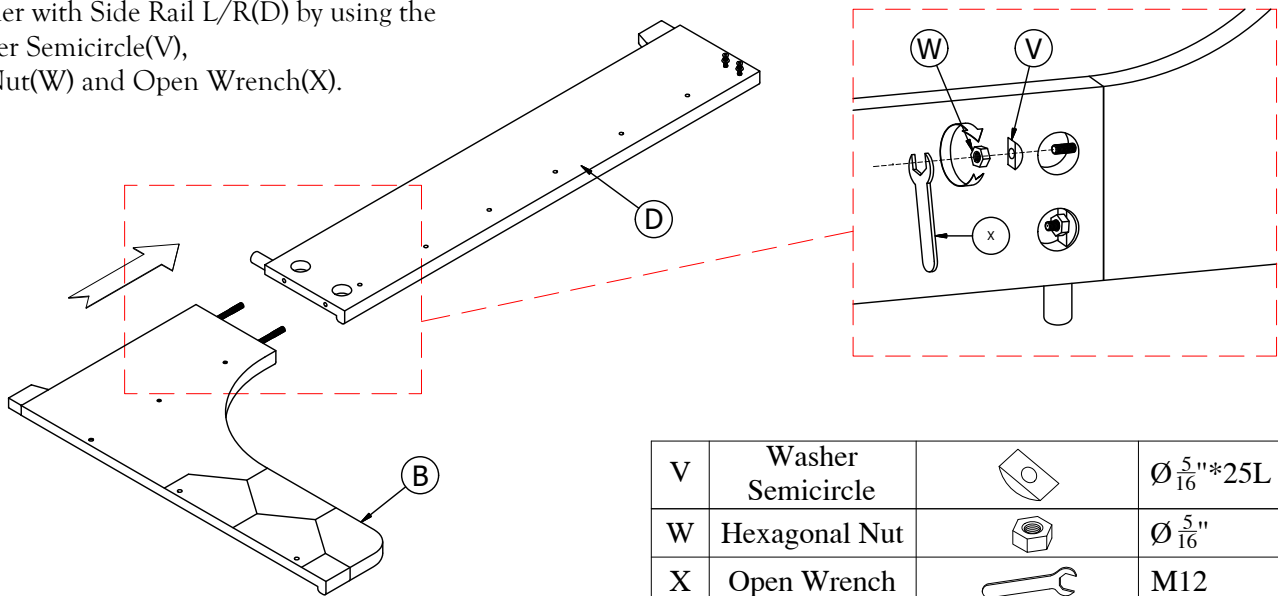

# ASSEMBLY INSTRUCTIONS





Item No : WF292011/12

Description : STORAGE BED

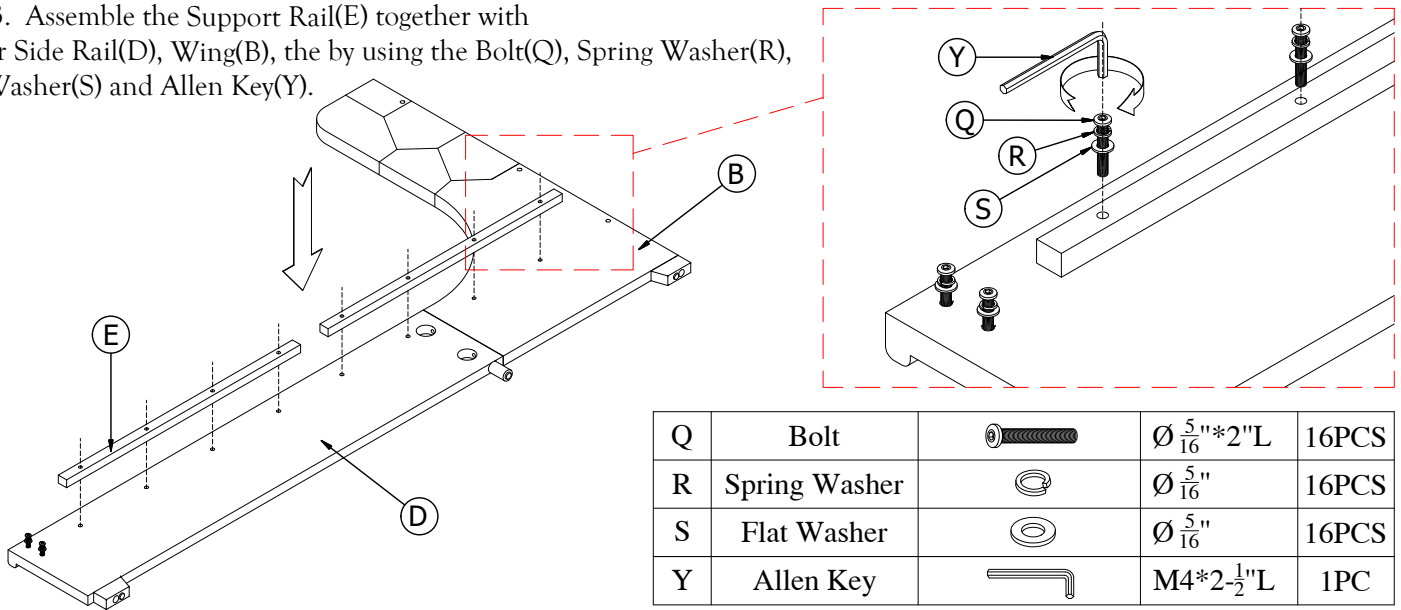
Thank you for purchasing this quality product. Be sure to check all packing material carefully for small part that may have come loose inside the carton during shipment.

Step 3. Assemble the Support Rail(E) together with cluster Side Rail(D), Wing(B), the by using the Bolt(Q), Spring Washer(R), Flat Washer(S) and Allen Key(Y).







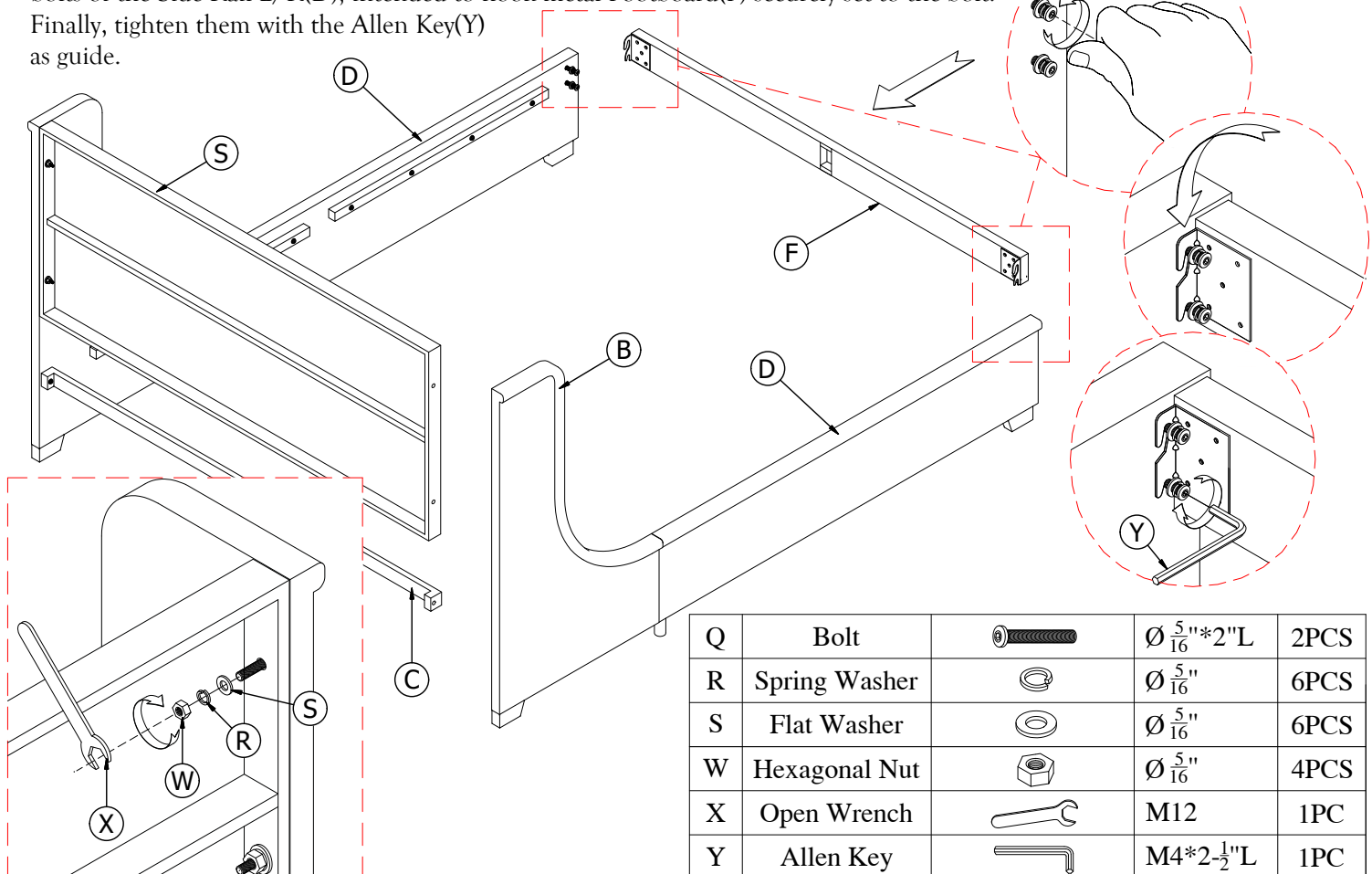

Q	Bolt		$\text{Ø} \frac{5}{16} \text{''} * 2 \text{''} \text{L}$	16PCS
R	Spring Washer		$\text{Ø} \frac{5}{16} \text{''}$	16PCS
S	Flat Washer		$\text{Ø} \frac{5}{16} \text{''}$	16PCS
Y	Allen Key		$\text{M4} * 2 - \frac{1}{2} \text{''} \text{L}$	1PC

Step 4. Assembled the Headboard panel(A) to the Wing HB(B), with two pre-assembled threaded rods, by using the Flat Washer(S) Flat Washer (R), Hex Nut(W), tighten them with the Open Wrench(X) as guide. Also, give the Stretch(C), the by using the Bolt(Q), Spring Washer(R), Flat Washer(S) and Allen Key(Y) as guide.

Next, put the Footboard(F) to Side rail(D). Before performing this step, please loosen the bolts of the Side Rail L/R(D), intended to hook metal Footboard(F) securely set to the bolt. Finally, tighten them with the Allen Key(Y) as guide.



Q	Bolt		$\text{Ø} \frac{5}{16} \text{''} * 2 \text{''} \text{L}$	2PCS
R	Spring Washer		$\text{Ø} \frac{5}{16} \text{''}$	6PCS
S	Flat Washer		$\text{Ø} \frac{5}{16} \text{''}$	6PCS
W	Hexagonal Nut		$\text{Ø} \frac{5}{16} \text{''}$	4PCS
X	Open Wrench		M12	1PC
Y	Allen Key		$\text{M4} * 2 - \frac{1}{2} \text{''} \text{L}$	1PC

# ASSEMBLY INSTRUCTIONS

Item No : WF292011/12

Description : STORAGE BED

Thank you for purchasing this quality product. Be sure to check all packing material carefully for small part that may have come loose inside the carton during shipment.

Step 5. Set Slat roll(M), link pre-wire up. Next, place the Short center support slats(J), align the drill holes. At the same time, use the Support leg(L) to pass through the holes on the Short center support slats(J) one by one, to link through the Slat roll(M) and tighten them together.

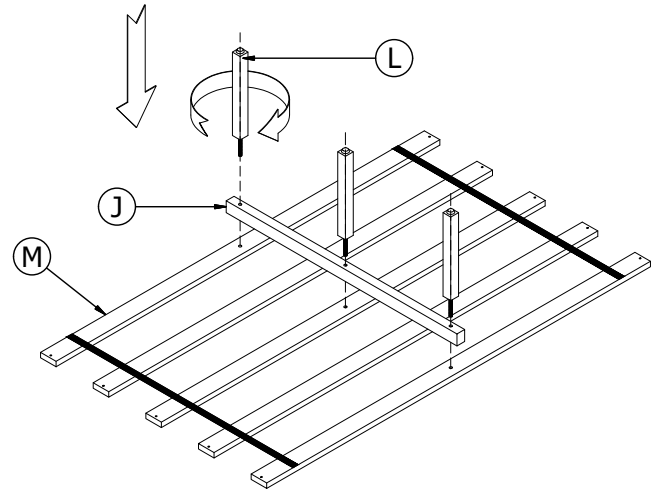



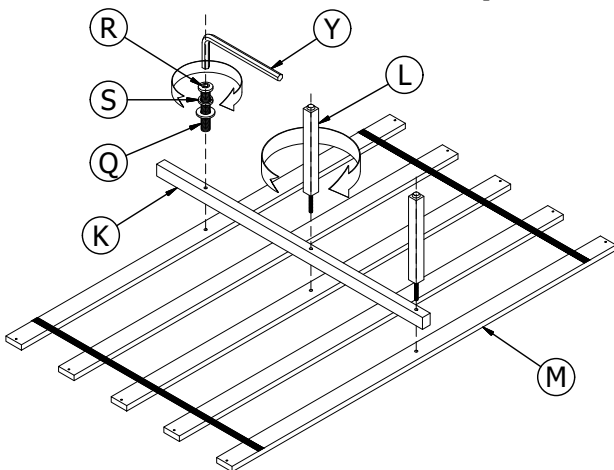

Step 6. Set Slat roll(M), link pre-wire up. Next, place the Long center support slats(K), align the drill holes.

At the same time, use the Support leg(L) to pass through the holes on the Long center support slats(K) one by one, to link through the Slat roll(M) and tighten them together.

Next the by using the Bolt(Q), Spring Washer(R), Flat Washer(S) and Allen Key(Y).



Q	Bolt		$\text{Ø} \frac{5}{16} \times 2'' \text{L}$	1PC
R	Spring Washer		$\text{Ø} \frac{5}{16}''$	1PC
S	Flat Washer		$\text{Ø} \frac{5}{16}''$	1PC
Y	Allen Key		$\text{M4} \times 2\text{-}\frac{1}{2}'' \text{L}$	1PC

Step 7. Put the two Slat roll clusters on the Side rail(D) of the bed to be neat, then tighten they are by Screws(Z).

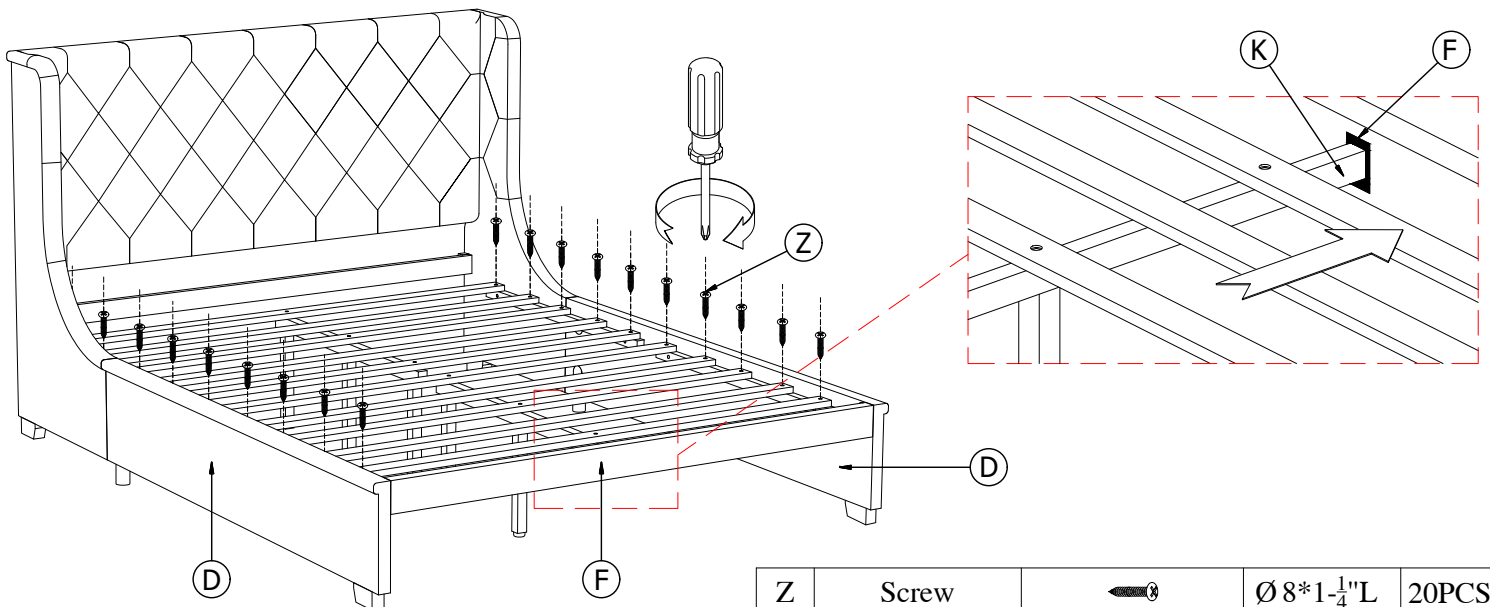

Z	Screw		$\text{Ø} 8 \times 1\text{-}\frac{1}{4}'' \text{L}$	20PCS
---	-------	---	---	-------

# ASSEMBLY INSTRUCTIONS



Item No : WF292011/12

Description : STORAGE BED

Thank you for purchasing this quality product. Be sure to check all packing material carefully for small part that may have come loose inside the carton during shipment.

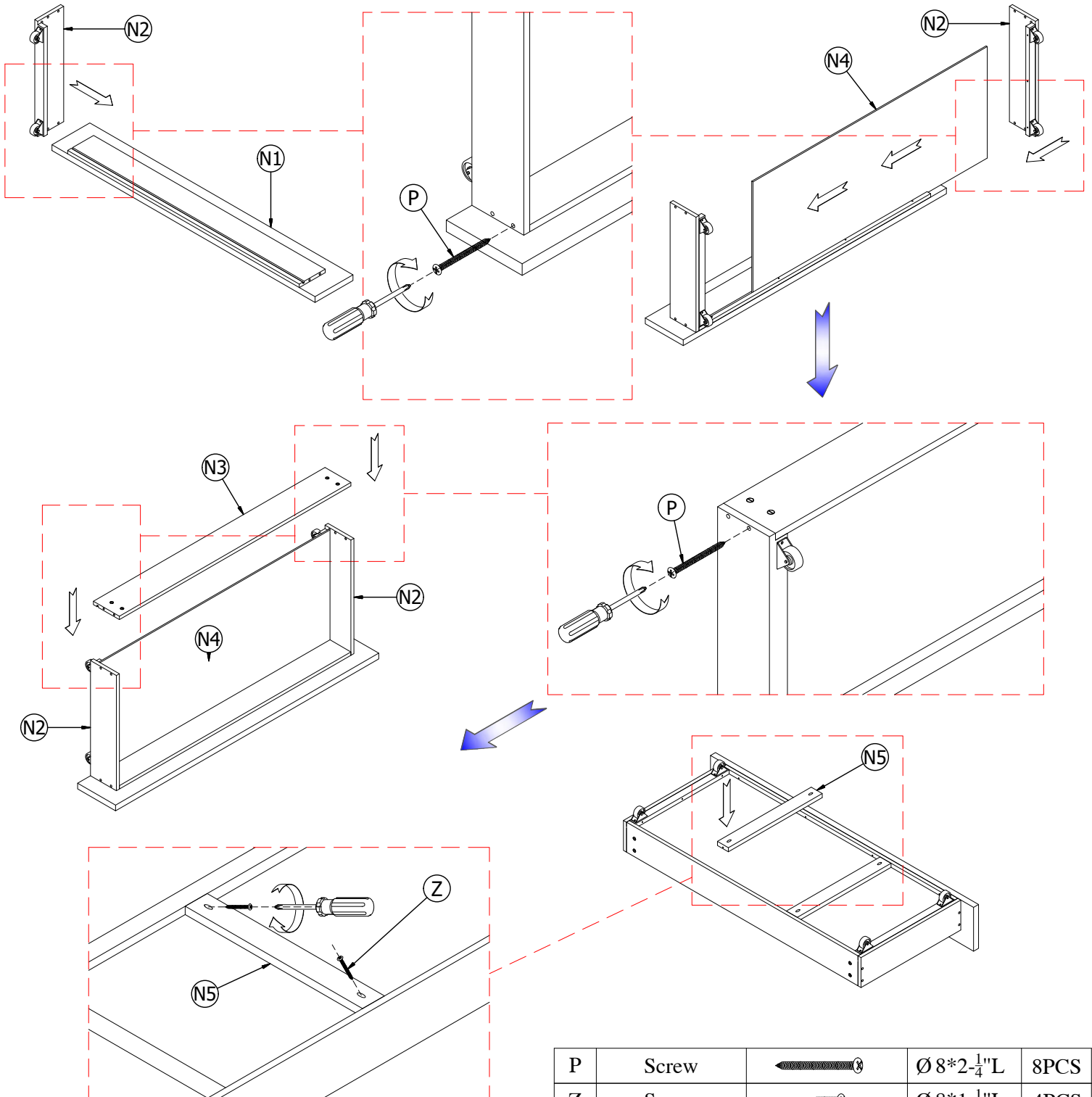
Step 8. Place the Drawer side plate(N2) with mount wheels to up on top of the back of Face Cushion(N1), aligning the drilled holes, by using the Screws(K) plase in to the small holes available, use screwdriver tighten them together. Next, give turn the Drawer bottom plate(N4) and the Drawer side Plate(N2) rest add also put on top of the back of face Cushion(N1), also by using the Screws(P) plase in to the small holes available, use screwdriver tighten them together. Next step, pass Drawer backs plate(N3) to in the Drawer side plate(N2) and Drawer bottom plate(N4). Aligning the drilled holes, by using the Screws(P) in to the small holes available, use screwdriver tighten them together. Finally, put the Bottom support bar(N5), use plase Screws(Z) in to the small holes available, use screwdriver tighten them together.



P	Screw		Ø 8*2-¼" L	8PCS
Z	Screw		Ø 8*1-¼" L	4PCS

# ASSEMBLY INSTRUCTIONS

Item No : WF292011/12

Description : STORAGE BED

Thank you for purchasing this quality product. Be sure to check all packing material carefully for small part that may have come loose inside the carton during shipment.

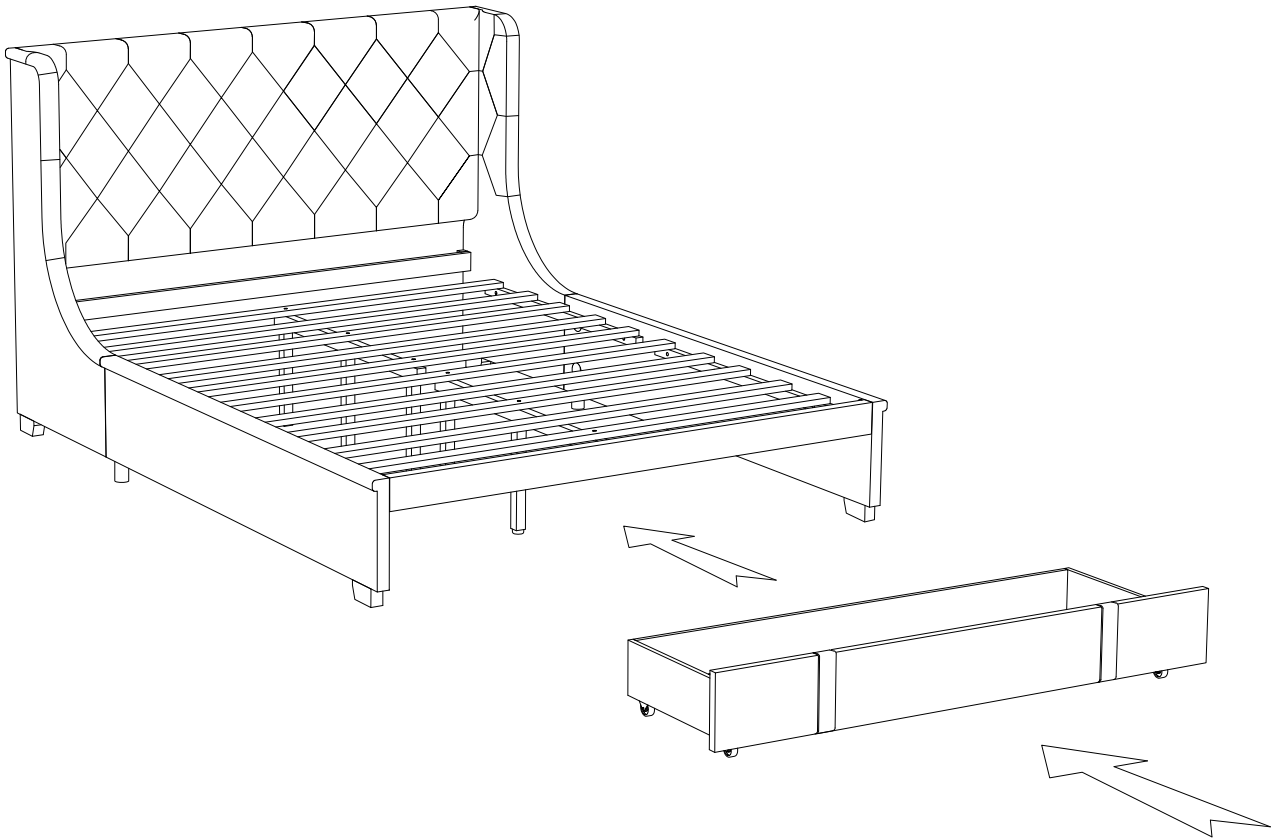

Step 9. Push drawers under the bottom of Bed.

