

MID-CENTURY MODERN

FOOSBALL TABLE



Warning

Adult Assembly Required

Asamblea de adultos de advertencia necesaria



MODEL # / No. de Mid-Century Modern

#26-1250

Assembly and Instructions/Asamblea e Instrucciones

Congratulations!

We hope you will have many hours of enjoyable use with your new Foosball Table!



PLEASE KEEP YOUR INSTRUCTIONS!

- Your Model number is necessary should you need to contact us.
- Please read through this instruction book to familiarize yourself with all the parts and assembly steps.
- Refer to the Parts Identifier and verify that all parts have been included.



WARNING!

This is not a child's toy. Adult supervision is required for children playing this game. Please read instructions carefully. Proper use of this set can avoid damage or injury.



BEFORE ASSEMBLY:

- Did you receive 1 box?
- Did you inspect your playfield/main table frame before assembly? It is not replaceable and must be returned to the original place of purchase if damaged.



TOOLS REQUIRED FOR ASSEMBLY:







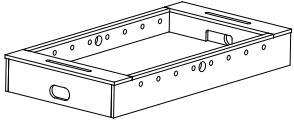
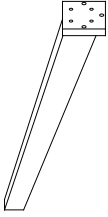
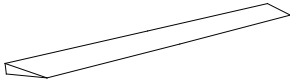
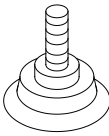
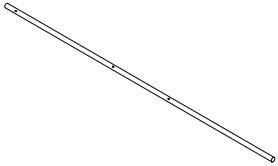
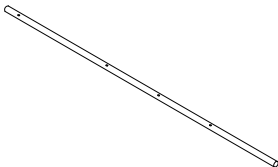
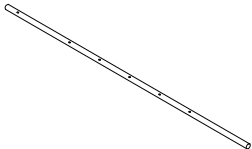

- Phillips and Slotted Head Screwdrivers / or Power Driver (not included)
- Allen Wrench (included)

ASSEMBLY INSTRUCTIONS:

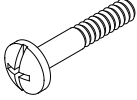
We recommend that two adults work together to assemble this table.

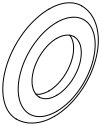
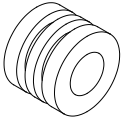
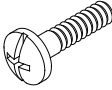
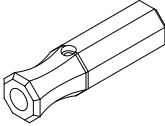
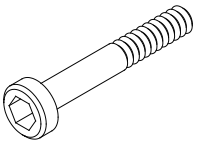
- The table will be assembled upside down This is a very heavy table and turning it right side up will require at least two strong adults.
- We suggest that you use the bottom carton as a clean flat work area to protect the top of your foosball table while assembling.

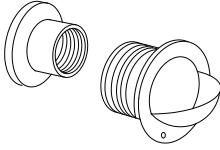
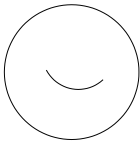
Parts List

<p>#1</p>  <p>Main cabinet 1 Piece</p>	<p>#2</p>  <p>Leg 4 Pieces</p>	<p>#3</p>  <p>Playfield trim 2 Pieces</p>	<p>#4</p>  <p>Leg leveler 4 Pieces</p>
<p>#5</p>  <p>Two player rod 2 Pieces</p>	<p>#6</p>  <p>Three player rod 4 Pieces</p>	<p>#7</p>  <p>Five player rod 2 Pieces</p>	<p>#8</p>  <p>Visit players 13 Pieces</p>
<p>#9</p>  <p>Home players 13 Pieces</p>	<p>#10</p>  <p>8#X1" Screw 26 Pieces</p>	<p>#11</p>  <p>Lock nut 26 Pieces</p>	<p>#12</p>  <p>Rod end cap 8 Pieces</p>
<p>#13</p>  <p>5/8"X38mm Plastic washer 16 Pieces</p>	<p>#14</p>  <p>Bumper 16 Pieces</p>	<p>#15</p>  <p>T5X15mm Bolt 8 Pieces</p>	<p>#16</p>  <p>Rod handle 8 Pieces</p>
<p>#17</p>  <p>5/16"x1-1/2" Bolt 12 Pieces</p>	<p>#18</p>  <p>5/16" Washer 12 Pieces</p>	<p>#19</p>  <p>F4X5/8" Screw 2 Pieces</p>	<p>#20</p>  <p>Ball entry cup 2 Pieces</p>
<p>#21</p>  <p>White ball 4 Pieces</p>	<p>#22</p>  <p>Allen key 1 Piece</p>		

Step 1:

Attach #2 into #1 main cabinet, tight with #18 washer and #17 bolt.

Then screw in #4 leg levelers.

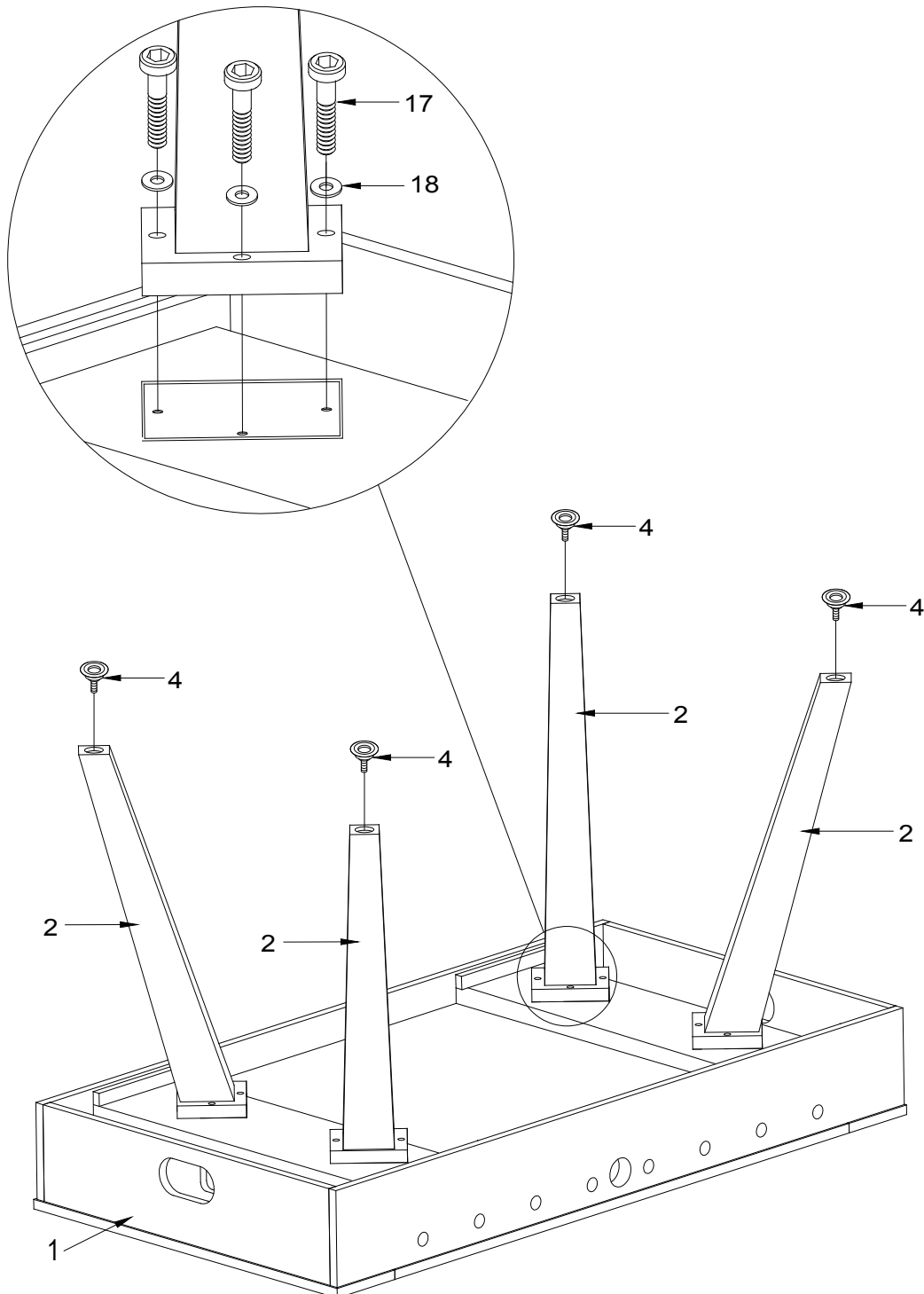

Step 2:

Using two strong adults turn the table right side up. Tear off the paper from #3 trim and paste on both side edges of the playfield.

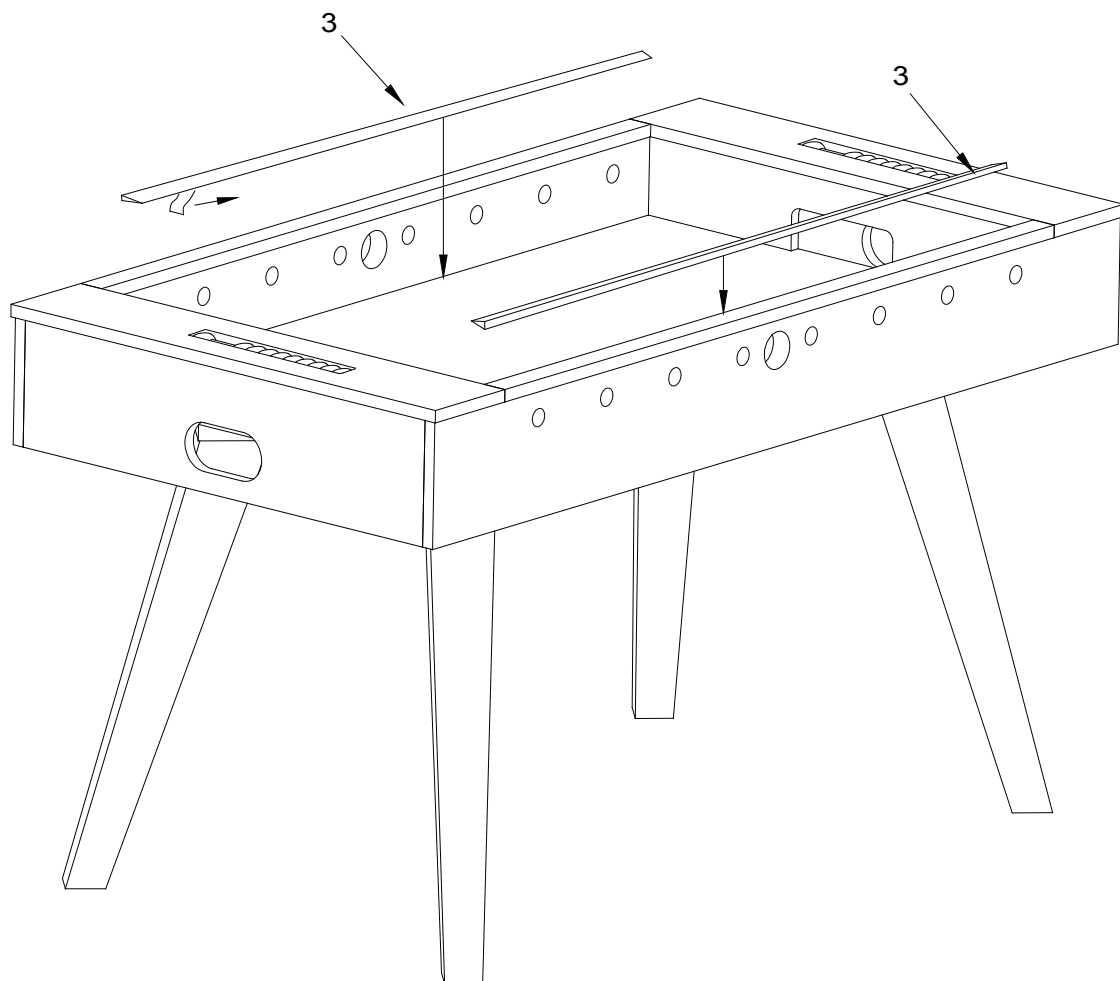

Step 3:

Note: set the rods into the right position according to the artwork.

The players of each team should be right-side up, facing their opponent's goal, follow the diagram below for proper rod placement

Slide one end of the player rods (#5, #6, #7) through the main cabinet according to the diagram below to identify where the two, three, and five player rods go in the cabinet.

Player rod assembly:

Place one #14 bumper & one #13 washer on the rod

Place the appropriate number of Attach #8 and #9 players to the rod #5 and #6 rod #7.

using #10 screw and #11 lock nut Place one #13 washer & one #14 bumper on the other end of rod. Slide the rods through the other end of the cabinet

Repeat the process for each rod

Note: The Rods have a hole at the end where their Handles will go.

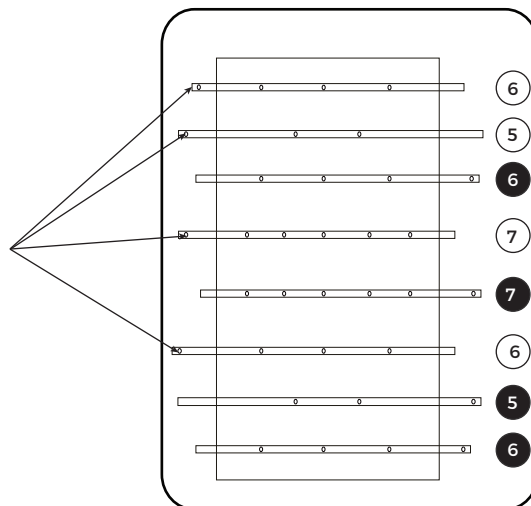

#8



Visit

#9



Home

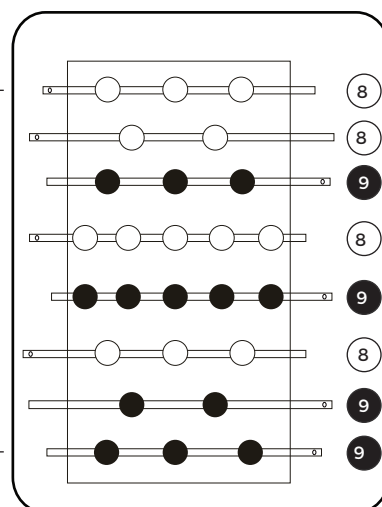

Step 4:

Attach the #16 handle to the rods using #15 screw. Put the #12 rod end cap on the other end of the rod,

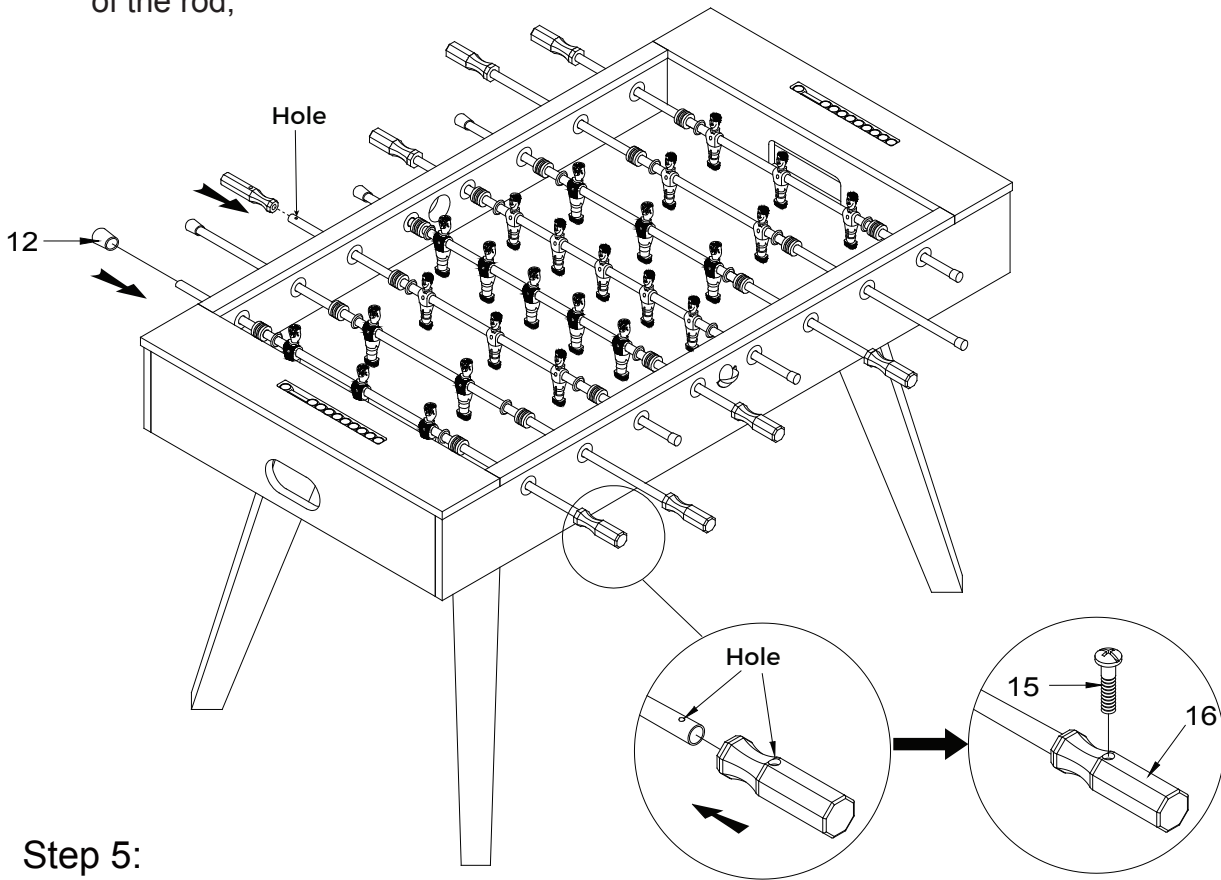

Step 5:

Attach the #20 ball entry cup to the main cabinet using #19 screw.

Then assembly is complete.

