

FRONT LOADING

Super Combo

Automatic Washer ⊕ Sensor Dryer

Model: 4400N

OWNER'S MANUAL

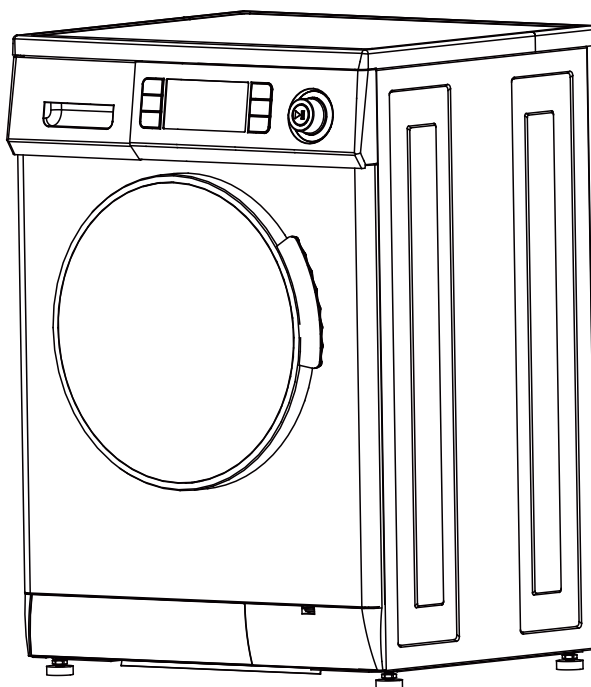

TABLE OF CONTENTS

Warranty.....	1
Technical Data.....	2
Introduction	4
Important Safety Instructions.....	5
Helpful Hints.....	6
Pre-installation.....	6
Diagram of the Combo	7
Installation Instructions	8
Unpacking leveling	9
Electrical	10
Plumbing	11
Ventilation	12
Recessed, Closet, Alcove.....	15
ADA Compliance	15
Program Selection Chart.....	16
Operating Instructions.....	17
Control Panel	18
Display Panel	19
Understanding Fabric Care Labels	20
Winterizing.....	21
Maintenance	21
Stain Removal Chart	22
Troubleshooting	24
Diagnostics Menu.....	26

**Please read the Owner's Manual carefully before using your
new Combo Washer-Dryer**

WARRANTY INFORMATION

Your appliance is protected by this warranty under normal, personal, family or household use (1Year), and limited commercial use (90 days), in USA and Canada.

WARRANTY

Consolidated Brands undertakes to the consumer-owner to repair or, at our option, to replace any part of this product which proves to be defective in workmanship or material under normal personal, family or household use, in the USA and Canada, for a period of one year from the date of original purchase. For commercial use, the product is warranted for a period of 90 days. During this period, we will provide all labor and parts necessary to correct such defect, free of charge, if the appliance has been installed and operated in accordance with the written instruction with the appliance. Ready access to the appliance, for service, is the responsibility of the consumer-owner. We may require return of products or parts to our warranty department for which the shipping charges are to be incurred by the consumer. If a return or replacement is required, allow 3-4 weeks to process. All repairs or replacements are warranted only for the remainder of the original warranty period. Charges may incur if warranty coverage is not applicable. Service would be provided from Monday to Friday between normal business hours.

GENERAL

Since it is responsibility of the consumer-owner to establish the warranty period by verifying the original purchase date, Consolidated Brands recommends that a receipt, delivery slip or some other appropriate payment record be kept for that purpose. Remember to send in your Warranty Registration Card so that a proof of your purchase exists with Consolidated Brands. You can also register online by typing the following link **www.ApplianceDesk.com**. This warranty gives you specific legal rights, and you may also have other rights which vary from State to State.

WARRANTY SERVICE

This warranty is given by:

**Consolidated Brands
10216 Georgibelle Drive, Suite 900D
Houston, TX 77043-5249**

For Service Contact:

Phone or Text: 1-800-776-3538
Email: service@appliancedesk.com
Web: www.ApplianceDesk.com

EXCLUSIONS

In no event shall Consolidated Brands be liable for incidental or consequential damages or for damages resulting from external causes such as abuse, operation misuse, neglect, alterations, normal wear and tear, incorrect voltage or acts of God. This warranty does not cover service calls which involve defective workmanship, damage due to other products while combined use with this product or materials covered by this warranty. Accordingly, diagnosis and repair costs for a service call which involves defective workmanship or materials will be the responsibility of the consumer-owner.

Most work is covered. The defining factor is has the machine malfunctioned (Consolidated Brands is responsible) or has the customer omitted or done something to cause or limitation of incidental or consequential damages, so the above limitation or exclusion may not apply to you.

THE FOLLOWING WORK ARE NOT COVERED UNDER WARRANTY:

Installation

1. Non-removal of shipping rods, causing vibration / internal damage.
2. Non-adjustment of feet to level machine, causing vibration / internal damage.
3. Non-removal of exhaust vent plate at the back while using Venting Dry mode, causing excess heat and resulting in damage to internal components.
4. Using incorrect length of venting i.e more than 10 feet unless used with a booster fan
5. Not conforming to minimum space requirements for Built-in installation, causing excess heat and resulting in damage to internal components.
6. Installation in a corrosive environment
7. Incorrect water pressure i.e below 7.25 psi or above 145 psi
8. Incorrect water inlet hose installation (use only factory supplied hoses with metric threads on the L shaped side to fit water valves)

Maintenance

1. Non-cleaning of coin trap for debris, causing the unit to not drain out water and resulting in drain pump malfunction.
2. Non-cleaning of vent fan & exhaust hose for lint, causing the unit to not dry properly.
3. Improper maintenance (such as but not limited to scale build-up, freeze damage, or vent blockage)

Damage

1. Breakage of cosmetic parts eg. Door handle, knob.

Other

1. Accident, abuse or misuse
2. Using of solvents to clean the machine or wash clothes causing damage.
3. Misapplication of this product e.g. Use in a non household/commercial environment.
4. Any other cause not due to defects in materials or workmanship
5. Problems or damage due to fires, flooding, electrical surges, freezing or any acts of God
6. Any damage cause by poor water quality
7. Operating the appliance with anything other than potable water at all times
8. Force majeure

TECHNICAL DATA

Model	4400N
Rated Voltage	110-120V/60Hz 13A
Washing input power	240 W
Spin input power	450 W
Capacity	13 lbs./ 6 kg
Spin Speed	1200 rpm
Programs	14
Water pressure	7.25-145 (psi) / 0.05-1(Mpa)
Dimensions (HxWxD)	33.5x23.6x22 (in) / 85x60x55.8 (cms)
Net Weight	161 lbs / 73 kg



Intertek
4007606

US N° 4007606 CANADA

The ETL Listed Mark is the legal equivalent to the UL and CSA Listed Marks

Note: All rights reserved.
Designs, Specifications and Manual subject to change without notice

INTRODUCTION

Congratulations on your new Super Combo. In addition to its contemporary design, this is a highly sophisticated engineered product that will give you many years of satisfaction.

Here are some of the best reasons for buying your Combo

1. Space Saving

By combining the two functions of washer and dryer in one unit, the space taken for the second unit, i.e. separate dryer, is saved.

2. Placement Options

The Washer-Dryer's sleek design makes it a perfect appliance for any Kitchen or Laundry Room. Its compact size makes the Washer-Dryer perfect for placement on each floor of your home.

3. Water & Energy Saving

New automatic water level feature determines with amount of water required based on quantity of clothes which helps save water. Also this appliance is engineered to provide valuable energy savings eg. LED display goes off after 5 mins to save energy.

4. Better Clothing Appearance

This Washer-Dryer has no agitator to damage your clothes so they look better and last longer. The refresh function keeps your clothes warm and fluffy always.

5. Flexible Drying option

With the option to change from a Condensing Dry system to a Vented Dry, you can decide on the ideal dry system depending on availability of a venting outlet.

6. High spin speed

With a high spin speed of 1200 rpm, more water is extracted, allowing improved dry times.

7. Easy Operation

This appliance is simple to use as a washer or as a dryer – or it can go seamlessly from wash to the dry functions.

8. Sensor Dry

This function automatically selects the ideal dry level to make sure your clothes are dried with utmost perfection based on wash cycle used.

9. Lint Free Maintenance

Since the machine has a self-cleaning pump, this appliance needs no cleaning of lint after drying. Instead, there is a convenient coin trap.

10. Portability

This appliance can be permanently installed and be made portable with the installation of the Portability Kit (Accessory Part# 1070 sold separately) where needed.

IMPORTANT SAFETY INSTRUCTIONS

Your safety and that of your children



Your Combo Washer-Dryer has been built in compliance with safety regulations, to protect you and your family.

WARNING – To reduce the risk of fire, electric shock, or injury to persons when using your appliance, follow basic precautions, including the following:

1. Read all instructions before using the appliance.
2. Do not wash or dry articles that have been previously cleaned in, washed in, or spotted with gasoline, dry-cleaning solvents, other flammable or explosive substances, as they emit vapors that could ignite or explode.
3. Do not allow children to play on or in the appliance. Close supervision of children is necessary when the appliance is used near children.
4. Before the appliance is removed from service or discarded, remove the door.
5. Do not reach into the appliance if the tub or drum is moving.
6. Do not install or store this appliance where it will be exposed to the weather.
7. Do not tamper with controls.
8. Do not repair or replace any part of the appliance or attempt any servicing unless specifically recommended in the user-maintenance instructions or in published user-repair instructions that you understand and have skills to carry out.
9. Do not add gasoline, dry-cleaning solvents, or other flammable or explosive substances to the wash water. These substances give off vapors that could ignite or explode.
10. Under certain conditions, hydrogen gas may be produced in a hot water system that has not been used for 2 weeks or more. **HYDROGEN GAS IS EXPLOSIVE.** If the hot water system has not been used for such a period, before using a washing machine or combination washer-dryer, turn on all hot water faucets and let the water flow from each for several minutes. This will release any accumulated Hydrogen.
11. Do not use fabric softeners or products to reduce static unless recommended by the manufacturers of the fabric softener product.
12. Do not use heat to dry articles containing foam rubber or similarly textured rubber-like materials.
13. Check the Coin Trap every few months to remove any coins, buttons or similar size objects.
14. For vented washer-dryers keep the exhaust opening and surrounding areas free from accumulation of lint, dust, and dirt.
15. Do not place items exposed to cooking oils in your dryer. Item contaminated with cooking oils may contribute to a chemical reaction that could cause a load to catch fire.
16. To reduce the risk of fire due to contaminated loads, the final part of a tumble dryer cycle occurs without heat (cool down period). Avoid stopping a tumble dryer before the end of the drying cycle unless all items are quickly removed and spread out so that the heat is dissipated.

SAVE THESE INSTRUCTIONS

SAFETY

 CAUTION 	The model number and the serial number are on the label affixed to the back of the unit. These numbers are also available on the front of the cabinet behind the door.
RISK OF ELECTRIC SHOCK DO NOT OPEN	You should note the model and serial numbers of this unit in the space provided. Retain this booklet as a permanent record of your purchase to aid in identification in the event of theft.
CAUTION: TO REDUCE THE RISK OF ELECTRIC SHOCK, DO NOT REMOVE COVER (OR BACK). NO USER SERVICABLE PARTS INSIDE. REFER SERVICING TO QUALIFIED SERVICE PROFESSIONALS.	MODEL# _____ SERIAL# _____

HELPFUL HINTS

1. Your Washer-Dryer spins at a high 1200 rpm spin speed, which will extract more water especially from absorbent fabrics and reduce the degree of dampness as the machine goes into the drying mode. This will cut down on your drying time.
2. **FABRIC SOFTENER:** After the wash cycle, the clothes can get stuck to the sides of the drum. USING LIQUID FABRIC SOFTENER WILL CAUSE THE CLOTHES TO UNSTICK IMMEDIATELY AND TUMBLE IN THE DRY CYCLE. THIS HELPS TO DRY CLOTHES FASTER AND CAUSES LESS WRINKLES.
3. **OVERLOADING:** The drum has a capacity of 13 lbs. The drum should be loaded only to 2/3 of its capacity otherwise it reduces air flow and causes increase in dry time.
4. **OVER DRYING:**
 - A) Condensing - Since there is no external exhaust system, the moisture content remains in the machine. Frequently when it seems the clothes are damp, it is actually the remaining moisture (like dew). Take clothes out and they will dry within a few minutes. Do not over dry the clothes.
 - B) Venting - It uses hot air to dry the clothes.
5. **USE HIGH EFFICIENCY (HE) DETERGENT:** By using High Efficiency (HE) detergent, you are preventing suds from entering the condensing chamber. When suds enter the condensing chamber, the particles can clog up the chamber and the fan blower. Over time, this reduces drying efficiency and may require the fan blower (impeller) to be cleaned. For this and all other front-loading/horizontal-axis units, High Efficiency (HE) detergents go a long way to improve the efficiency of the units.
6. **SORTING:** When sorting laundry always take into consideration the quantity and type of fabric contained in the load. Highly absorbent fabrics such as those used in towels or jeans will absorb more water and become very heavy when saturated. If you notice that your clothes are taking longer than usual to dry you may be overloading the machine, or washing too many highly absorbent articles for a single load.

PRE-INSTALLATION

1. The unit must be installed on a strong leveled surface in a protected, dry and well-ventilated area, with a power and water supply of sufficient capacity and a sufficient outlet in close proximity.
2. Installation on Carpet or Wood increases vibrations.
 - Carpets – place on light carpet only.
 - Wood – brace floor with screws and place additional sheets of plywood before installation.
3. This unit's installation and grounding should be done in accordance with local codes by a qualified installer. "Installation Instructions" are included in this manual for the Installer's reference.
4. The unit should be plugged into a properly grounded three (3) prong electrical outlet of 110V/60Hz with minimum 15 Amps, It should not be controlled by a wall switch or pull cord which might be turned off accidentally.

DIAGRAM OF THE COMBO WASHER-DRYER

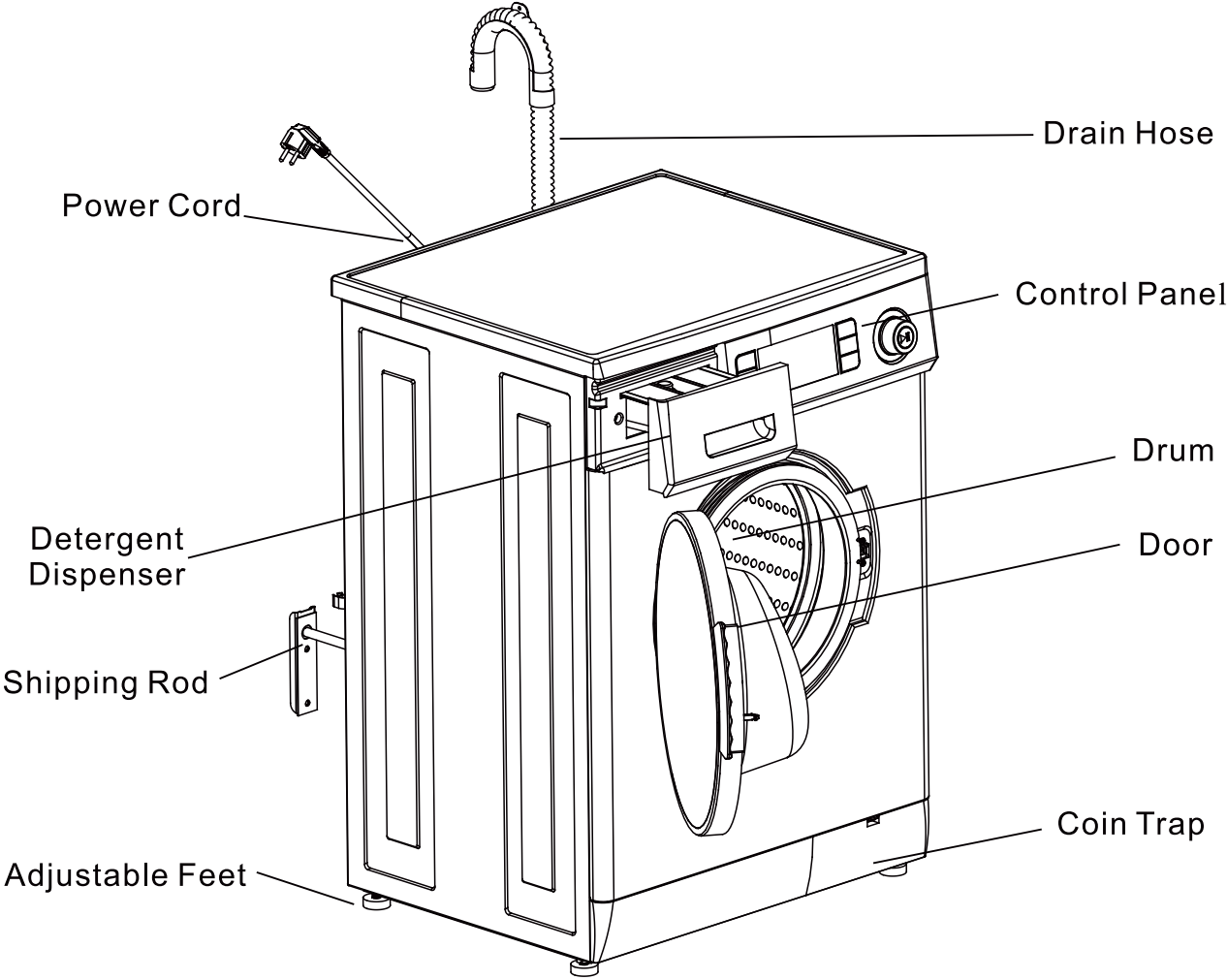

Factory supplied accessories

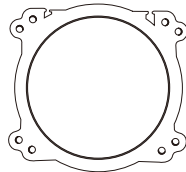
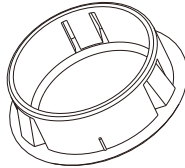
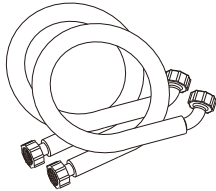

INSTALLATION INSTRUCTIONS

Handling

Please handle the machine carefully and use appropriate means while lifting and moving the machine so that it does not get damaged. Do not drag the machine to your floor and, or, to the machine. Do not hold on to protruding parts when lifting

Disposing of the packing

The shipping package has protected your new washing machine on its way to your home. All packaging materials are non-polluting and recyclable. Please contribute to a better environment by disposing of packing material in an environmentally conscious manner.

⚠ DANGER ⚠

Keep children away from the shipping carton and packing components. Danger suffocation from plastic foil and folding cartons.

Disposing of your old appliance

Old Appliances are not worthless trash! Valuable raw material can be recycled from old appliances. To prevent children from locking themselves in the appliances, disable the door locking or remove the door.

Factory - supplied Equipment

Inside the drum there is a packet of accessory parts supplied with your washer. Check that all the accessory parts supplied for your model are there. If any parts are missing contact your dealer.

Any residual moisture inside the drum is due to the final testing which every washing machine undergoes before leaving the factory.

⚠ CAUTION ⚠

California Proposition 65

WARNING: This product contains chemicals known to the State of California to cause cancer and birth defects or other reproductive harm.

Installation area

⚠ DANGER ⚠

Appliance stability is very important otherwise washing machine could "wander" during the spin cycles.

The installation area must be solid and even. Soft floor surfaces such as carpets or surfaces with foam backing are not suitable.

⚠ DANGER ⚠

Do not install the washing machine outdoor or in an area exposed to freezing condition. frozen hoses can tear / burst.

If the washing machine is located in a room which will be exposed to temperatures below freezing point, or if it is located in a cabin that is being shutdown for the winter, any residual water in the pump or water inlet hoses must be drained.

Removing the shipping rods

⚠ CAUTION ⚠

The shipping rods must be removed before using the appliance for the first time and must be retained for any future transport. (e.g when moving)

⚠ DANGER ⚠

Use Venting dry mode only after removal of rear vent plate covering exhaust fan as it is a fire hazard.

UNPACKING, LEVELING & POSITIONING

Remove the packing and check that the Washer-Dryer is undamaged. If you have any doubt, do not use the Washer-Dryer and call Customer Service. Keep all packing parts (plastic bag, foam rubber, screws, etc.) out of the reach of children since they could be dangerous.

Important: The inside of the Washer-Dryer consists of a free floating drum that is affixed with shipping rods at the back of the cabinet during transport (Fig.1). The power cord can be accessed by removing the shipping rods (Fig. 2 & 3). Close the holes left open by the rods with the caps provided (Fig. 4). The screws also need to be reinstalled (Fig. 4).

It is important for the machine to be perfectly level. For this reason, the machine is fitted with adjustable feet used for leveling the machine before use (Fig. 5).

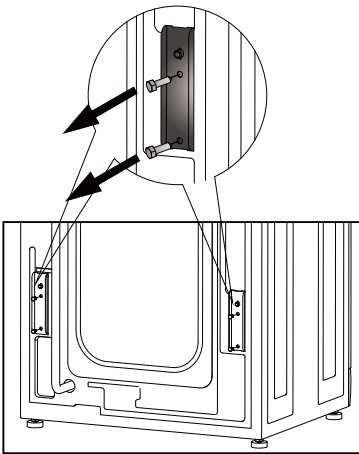

Fig. 1



Fig. 2

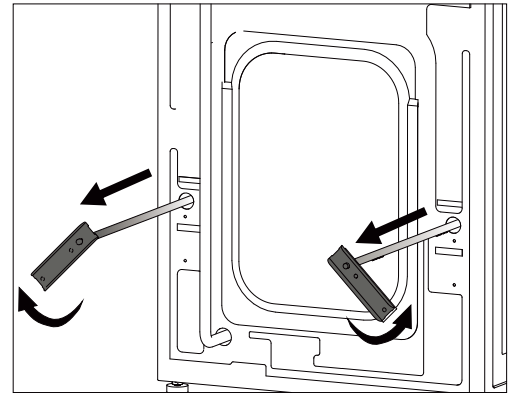

Fig. 3

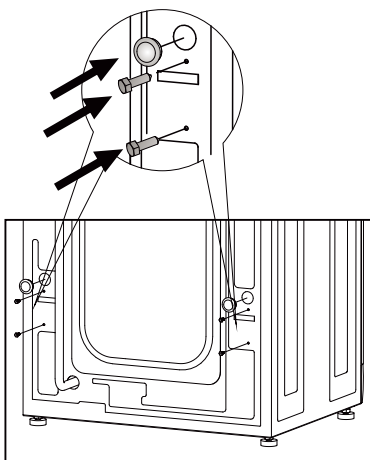

Fig. 4

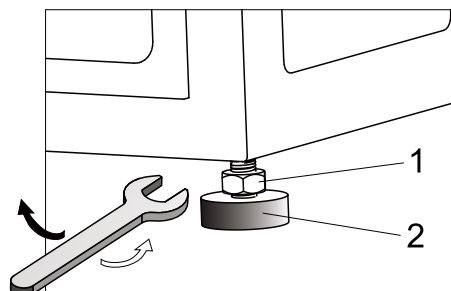

Fig. 5

ELECTRICAL

CONNECTION

Connect the plug to a power outlet - 110V/60Hz with minimum 15 Amps. Make sure that the voltage and frequency available correspond with those stated on the serial number plate located on the machine. Do not use adaptors or extension cords since they could result in overheating and burn out.

POWER SUPPLY

This Washer dryer must be connected to an individual circuit identical to the one specified on the rating plate of the loading port protected by fuses or circuit breaker conforming to local codes.

GROUNDING

This appliance must be grounded. In the event of malfunction or breakdown, grounding will reduce the risk of electric shock by providing a path of least resistance for electric current. This appliance is equipped with a power cord having an equipment-grounding conductor and a grounding plug. The plug must be plugged into an appropriate outlet that is properly installed and grounded in accordance with all local codes and ordinances.

WARNINGS

- Improper connection of the equipment-grounding conductor can result in a risk of electric shock. Check with a qualified or service representative or personnel if you are in doubt as to whether the appliance is properly grounded.
- Do not modify the plug provided with the appliance: if it will not fit the outlet, have a proper outlet installed by a qualified electrician.

Note: If the electrical power supply does not meet the specifications listed above, please call a licensed electrician.

PLUMBING

CONNECTING TO THE WATER FAUCET

Please read the following steps carefully

1. Connect the straight end of the hot-water hose to the hot-water faucet (Fig.5)
2. Connect the straight end of the cold-water hose to the cold-water faucet (Fig.5)
3. Connect the L-shaped end of the hot-water hose to the inlet valve marked "H" (Fig.6)
4. Connect the L-shaped end of cold-water hose to the inlet valve marked "C" (Fig.6).

CONNECTING THE DRAIN HOSE

Connect the drain hose to a drain duct (with internal diameter of at least 1.6 inches) or place it for drainage in to a sink or a tub, ensuring that there are no kinks or bends. The free end must be at a height of 24"-40" from the floor. The hose can be held in place using the black plastic clamp on the upper part of the back panel (Fig.6)

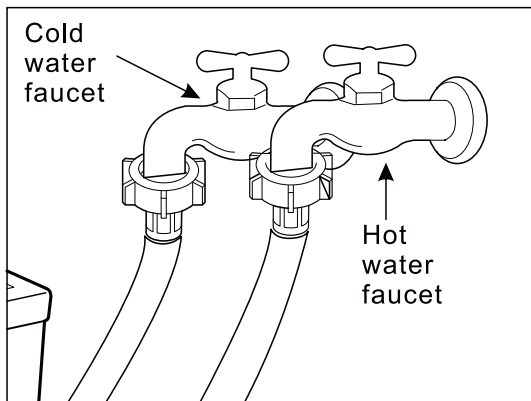

(Fig.5)

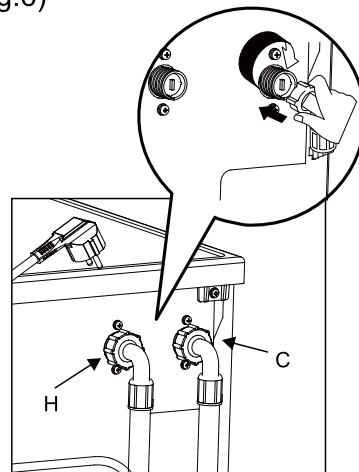

(Fig.6)

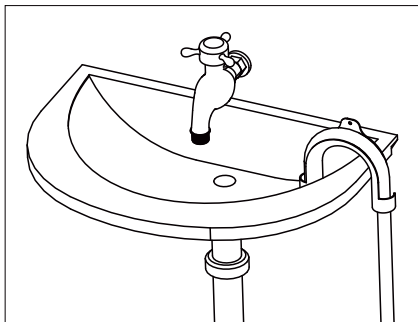

(Fig.7)

Height difference between the installation location of the washing machine and the drainage point:
Minimum 24", and Maximum 40".

- Attach water drain hose to U-Connector.
- Hook the U-Connector over the side or stand pipe (Fig 7.)
- When the water is being drained, check that the water flow out of the hose is adequate.

CONDENSING DRY

To use dryer in Condensing Mode:

1. Ensure metal vent cap (1) is installed on exhaust fan.
2. Press "Dry Only" button to set the machine on drying cycle.
3. Hold venting/condensing button for 5 seconds
4.  symbol will appear on the screen which confirms that the machine is in condensing mode.
5. Press start to run dryer in condensing mode

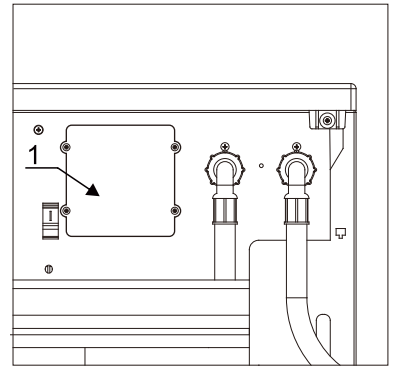

Condensing dry uses cold water to dry the clothes. The cold water mixes with the hot air in a condensing chamber within the machine. Please ensure the cold water faucet is open during condensing dry mode.

Note: Slight condensation can occur at soap dispenser and will evaporate. This is a normal feature.

VENTING DRY

To use dryer in Venting mode:

1. Ensure metal vent cap on exhaust fan located at the back is removed .
2. Press "Dry Only" button to set the machine on drying cycle.
3. Hold venting/condensing button for 5 seconds
4.  symbol will appear on the screen which confirms that the machine is in venting mode.
5. Press start to run dryer in venting mode

Connecting the dryer vent duct

For venting function the machine vents the moist hot air out of the unit and requires a vent hose (standard 4") to be installed.

Vent hose adapter is provided along with the machine which needs to be installed on exhaust fan.

To install the vent hose, attach the vent hose (2) onto the vent hose adapter (1).

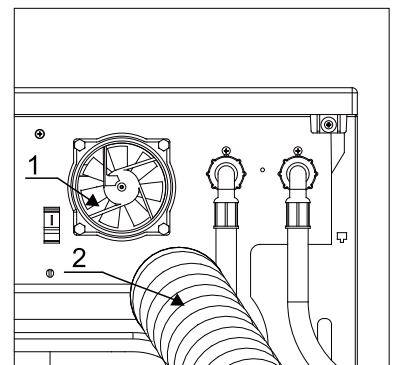

Fig.8

INSTALLATION INSTRUCTIONS FOR EXHAUST



IMPORTANT: Installation and service must be performed by a qualified installer. Please have a qualified service agent install your dryer.

NOTE: The **WARNING** and **IMPORTANT** instructions appearing in his manual are not meant to cover all possible conditions and situations that may occur. It must be understood that common sense and being careful are factors that **CANNOT** be built into the dryer. These factors **MUST BE** supplied by the persons installing, maintaining, or operating the dryer.

WARNINGS

MAXIMUM LENGTH OF THE VENT HOSE IS 10 FEET WITH THE 0.5 AMPS ORIGINAL EXHAUST FAN. USING LONGER VENT HOSE MAY DAMAGE INTERNAL COMPONENTS. FOR LONGER VENT HOSE USE 1.5 AMPS EXHAUST FAN, WHICH IS AVAILABLE AS AN ACCESSORY.

DUE TO RISK OF FIRE USE ONLY METALLIC DUCT (RIGID OR FLEXIBLE).

Never use flexible duct inside the dryer.

Do not terminate exhaust in a chimney, range hood, gas vent, floor or attic. The combination of lint and grease could create a fire hazard or damages.

Provide an access for inspection and cleaning the exhaust system at least once a year.

EXHAUST SYSTEM CHECK LIST HOOD OR WALL CAP

Terminate in a manner to prevent back drain or entry of birds or other wildlife.

Termination should present minimal resistance to the exhaust air flow and should require little or no maintenance to prevent clogging.

Wall caps must be installed at least 12" (30 cm) above ground level or any other obstruction with the opening pointed down.

If roof vents or louvered plenums are used, they must be equivalent to a 4" (10 cm) dampened wall cap in regard to resistance to air flow. Prevention of back drafts and regular maintenance are required to prevent clogging.

SEPARATION OF TURNS

Separate all turns by at least 3ft. (1m) of straight duct, including distance between last turn and dampened wall cap. If two turns must be closer than 3ft. (1m) deduct 10ft. (3m) from the maximum length

URNS OTHER THAN 90°

One turn of 45° or less may be ignored.

Two 45° turns should be treated as one 90°

Each turn over 45° should be treated as one 90°.

SEALING OF JOINTS

All joints should be tight to avoid leaks. The male end of each section of duct must point away from the dryer.

Do not assemble the duct work with fasteners that extend into the duct. They will serve as a collection point for lint.

Duct joints can be made air and moisture-tight by wrapping the overlapped joints with duct tape.

INSULATION

Duct work which runs through an unheated area or is near an air conditioning duct, should be insulated to reduce condensation and lint build up and be sloped down toward outdoors.

NOTE: Never install screen inside exhaust duct.

WARNING: THIS MACHINE MUST BE EXHAUSTED OUTDOORS WHEN OPERATED IN THE VENTING MODE. THIS IS TO PREVENT LARGE AMOUNTS OF LINT AND MOISTURE FROM ACCUMULATING AND TO MAINTAIN DRYING EFFICIENCY.

ATTENTION: IN VENT DRY MODE, THE EXHAUST FAN AND EXHAUST DUCT SHOULD BE CLEANED ONCE A YEAR.

SPECIAL INSTALLATION REQUIREMENTS

MINIMUM CLEARANCE OTHER THAN ALCOVE OR CLOSET INSTALLATIONS.

Minimum clearances to combustible surfaces: 2" clearance both sides and 3" rear.

MOBILE HOME INSTALLATION

The dryer must be exhausted to the outdoors with the termination securely fastened to the mobile home structure. (See **EXHAUST INFORMATION** section.)

The exhaust **MUST NOT** be terminated beneath the mobile home.

Provisions must be made for the introduction of outside air into the dryer. The free air opening shall not be less than 12 sq. inches.

The exhaust duct material **MUST BE METAL**.

The dryer must be attached to the floor following instructions available from the dealer.

Installation must comply with the current **CAN / CSA Z240MH** series Mobile Home Installation Codes.

BUILT-IN, RECESSED, CLOSET AND ALCOVE INSTALLATION

The Combo Washer-Dryer may be installed in a built-in, recessed area, closet or alcove.

The installation spacing is in inches and is the minimum acceptable.

Other installations must use the minimum dimension indicated.

Minimum clearances between dryer cabinet and adjacent walls are: 2" either side and 3" front and rear.

Minimum vertical space from floor to overhead cabinets, etc. is 52" (132cm).

Closet door must be louvered or otherwise ventilated and must contain a minimum of 60 sq. in. of open area equally distributed. If this closet contains both a washer and a dryer, doors must contain a minimum of 120 sq. in. of open area equally distributed.

No other fuel-burning appliance shall be installed in the same with closet with dryer.

★ Additional clearances for wall, door and floor molding may be required.

★★ Additional space is needed when an external exhaust elbow is used.

NOTE: If a door is installed that potentially encloses the unit while running, the door must allow for a minimum of 20 square inches of free air movement. There must also be a 1" space in front of the unit to the closed door and 1" from the back of the unit to the wall. Additional spacing should be considered for easy installation, servicing and compliance with applicable local, state, and federal codes.

For **Venting Use**, see Fig 9,

For **Condensing Use**, see Fig 10.

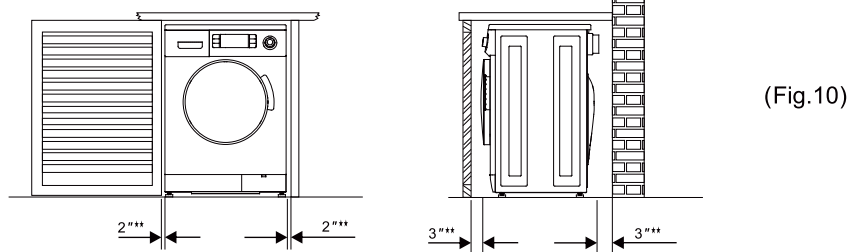
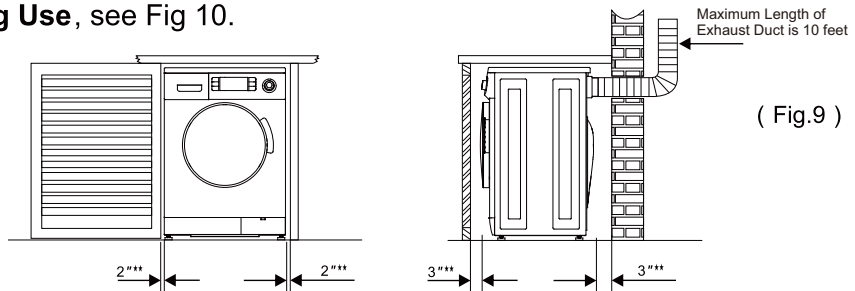

ADA COMPLIANCE

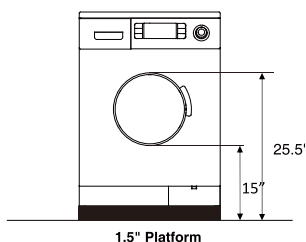

Use 1.5" height platform to make the machine ADA compliant.

PROGRAM SELECTION CHART

1. WASH & DRY, WASH ONLY, DRY ONLY

Program	Description of load	Wash features Water temp/Spin rpm/ Duration	Drying heat & approx time
1 – Prewash+Heavy	Thick cottons (towels, jeans)	Hot / 1200 / 1.23 hours	Max heat - 1300W 120 minutes
2 – Heavy	Mixed cottons (t-shirts, jeans)	Hot / 1200 / 1.08 hours	Max heat - 1300W 120 minutes
3 – STANDARD	Mixed cottons	Warm / 1200 / 55 minutes	Max heat - 1300W 100 minutes
4 – Quick 20	Cotton blends, light fabrics	Cold / 1200 / 20 minutes	Max heat - 1300W 80 minutes
5 – Baby	Cotton blends, light fabrics	Warm / 500 / 40 minutes	Half heat - 750W 60 minutes
6 – Delicate	Silks	Cold / 500 / 40 minutes	Less Heat - 550W 60 minutes
7 – Wool	Woolens	Cold / 500 / 40 minutes	No heat Tumble dry only
8 - Quiet	Mixed cottons	Cold / 500 / 35 minutes	Half heat - 750W 60 minutes

2. DRY CYCLES

Refresh - 12 minute cycle blowing hot air onto the clothes.

Time Dry 60 - 60 minutes dry cycle.

3. OTHER CYCLES:

Rinse/Spin - Rinse + spin cycle.

Drain only - Drain water from the machine.

Self clean - 9 minutes cycle to clean the inner drum and tub of the machine

Winterize - 2 minute cycle to winterize your appliance. (follow procedure on page 19)

OPERATING INSTRUCTIONS

1. Ensure the Combo Washer-Dryer is turned off. (Power Indicator light should be off).
2. Separate clothes by type, color and degree of soiling.
3. For small items such as socks, children's garments and small towels please use a **Washing Net Bag**.
4. Load clothes of the selected type loosely into the drum.
If you are only washing clothes, you can fill the drum.
If you are washing and then drying, please do not load clothes more than 2/3 full.
5. Close the Washer-Dryer door. You will hear a click when it is correctly closed.
Use High Efficiency (HE) detergent about 1 table spoon.
Add detergent to Dispenser A.
You can add fabric softener and pre-wash detergent as shown in the diagram to compartment B & C.

Detergent Dispenser

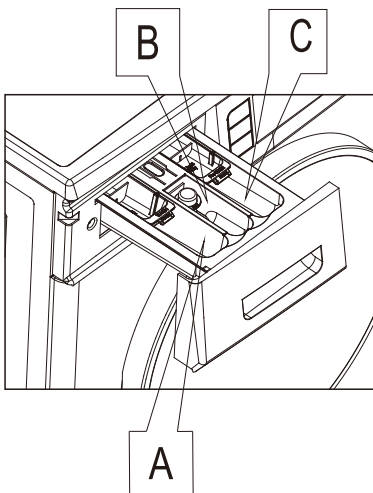

Dispenser A:
Detergent for main wash

Dispenser B
Fabric softener

Dispenser C
Detergent for pre-wash.

**The blue cups are only for liquid detergent.
Please do not add powder in these cups.**



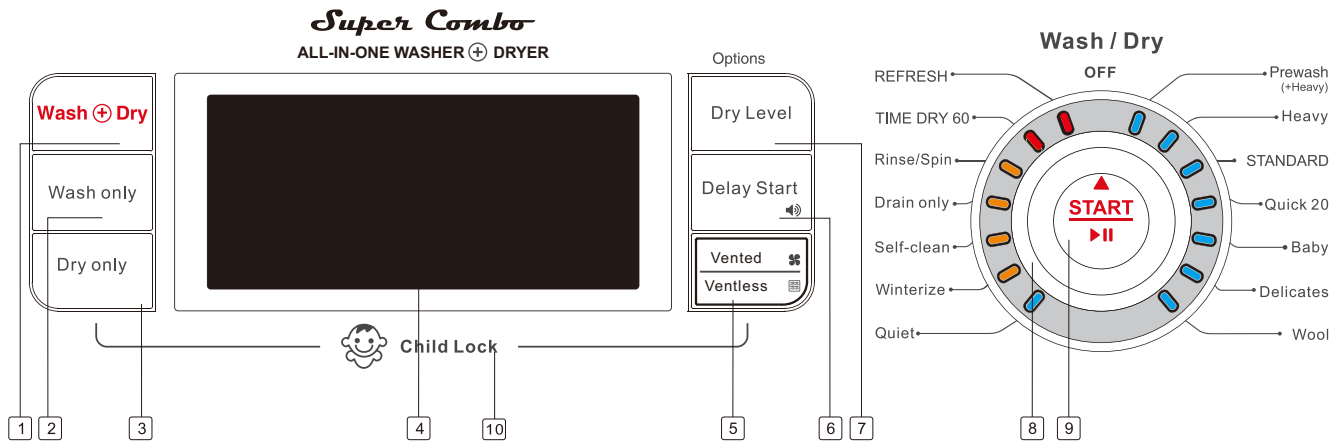

Note: concentrated fabric softener must be diluted with a little water before being poured into the dispenser
(This prevents the overflow siphon from getting blocked)

Add detergent in Dispenser C, only for Pre-Wash cycle.



Control Panel



Buttons Introduction

- 1 Wash ⊕ dry To select Wash & Dry cycle together.
- 2 Wash Only To select Wash cycle only
- 3 Dry Only To select Dry cycle only
- 4 Color LED Display To display the selected program, such as the water selection, spin speed, remaining time, rinse times, water level and error messages.(See page 18 for details)
- 5 Vented/Ventless selection button Press this selection button for 5 seconds to select either the venting dry cycle or the condensing dry cycle. The default condition is the condensing cycle. The symbol  will be displayed, if you are using the condensing dry cycle and symbol  will be displayed for venting dry cycle.
- 6 Delay Start (🔊) button Press this button to select the delay time from 1 to 24 hours in one hour increments before the wash cycle started. Press this button for 5 seconds to turn the chime on  or chime off  after the wash cycle started.

If a change is to be made after the delay start time is set, turn the dial to “OFF” position, select the desired program again.

- 7 Dry Level button Press this button to select the dry level for a Sensor Dry cycle. The default is Normal and you can select Extra, Low or Damp Dry.
- 8 Program Dial Turn dial to point to one of the 14 programs depending on the load to turn the unit on. Move it to the OFF position to turn the unit off.
- 9 Start/Pause button Press this button to start or interrupt the selected wash program, or to view the program during a cycle.
- 10 Child Lock In order to deactivate function to the controls, to prevent altering cycle, press and hold the "Venting/Condensing" and "Delay Start" buttons.
If a sensor dry cycle is selected, the symbol  will be displayed.
If a time dry cycle selected, the symbol  will be displayed.

Display Panel Symbols

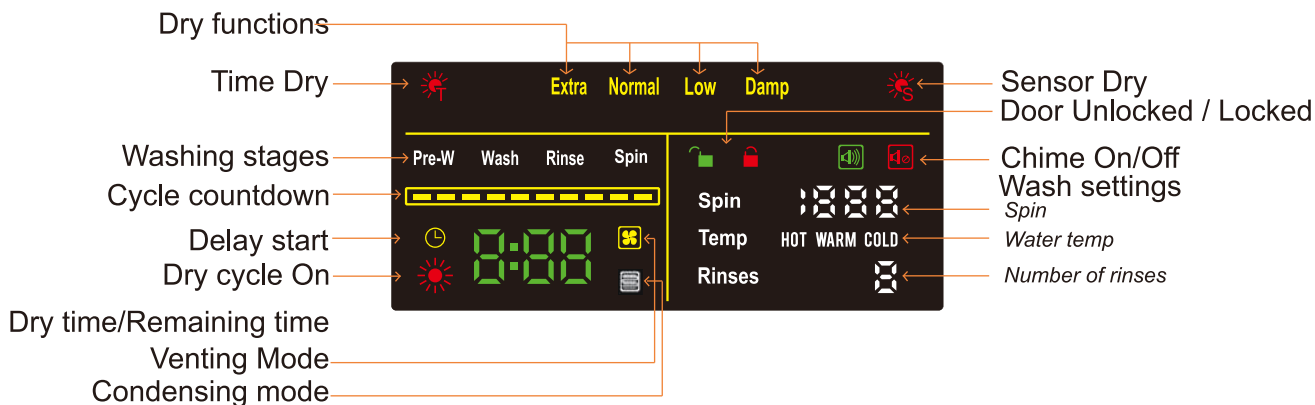

How to Run a Wash Cycle and Dry Cycle

- A** 1. Press Wash+Dry button to power the machine on, the cycle will go to STANDARD and the indicator  (sensor dry) will be on.
2. Press the Start button to run the STANDARD wash cycle and sensor dry cycle.

To select one of the other wash cycles (Prewash+Heavy, Heavy, Quick 20, Baby, Delicates wool or Quiet) rotate the knob and then press the Start button to run the selected cycle and sensor dry cycle

If you rotate the knob to one of the Option cycles (Winterize, Self-clean, Drain only and Rinse/Spin), the indicator  will be off. Press the Start button to run the selected cycle.

OR

- B** 1. Rotate the knob to power on the machine and select one of the cycles, press the Wash+Dry button.
2. Press the Start button to run the selected wash cycle and sensor dry cycle.

Before starting the cycles, you can change the default dry level by pressing the Dry Level button.

How to Run a Wash Cycle only

- A** 1. Press Wash only button to power the machine on. The cycle will go to STANDARD then press Start button to run this cycle.
2. Rotate the knob to one of the other cycles. Press the Start button to run the selected wash cycle.

OR

- B** 1. Rotate the knob to one of the cycles to power the machine on and press the Wash only button.
2. Press Start button to run the selected wash cycle.

How to Run a Dry Cycle only

- A** 1. Press Dry only button to power the machine on, the cycle will go to STANDARD cycle.
2. Press Start button to run a sensor dry cycle at the STANDARD conditions.

Rotate the knob to any of the other cycles and press Start button to run a sensor dry cycle at the selected cycle conditions.

OR

- B** 1. Rotate the knob to one of the cycles to power the machine on and press Dry only button.
2. Press Start button to run the sensor dry cycle at the selected cycle conditions.

Add-a-sock Feature

The wash program can be stopped at any time to add forgotten items to the laundry.

- Press PAUSE for 5 seconds.
- Door will open 2 mins after draining water so that it does not overflow.
- Load clothes. Close door.
- Press START The cycle will continue from the point it stopped

How to stop the wash cycle

- The wash program can be stopped at any time.
- Press pause for 5 seconds
- Turn knob to OFF position
- To drain water turn knob to DRAIN ONLY on left side.



How to stop the dry cycle

- Turn knob to OFF position
- The door can be opened at any time during the dry cycle after the first 2 minutes.

How to turn on the display in energy saving mode?

- Press any button or turn the knob

Understanding the door lock function

Pressing the start button  will lock the door  → . The wash cycle will start and will continue until the whole program is completed. The door will be locked and cannot be opened until 2 minutes after the wash cycle ends. Please do not try to force the door open. **Breakage of the door handle is not covered by warranty.**

In the drying cycles, the door can be opened when the symbol  displays on the screen.

USEFUL TIPS

Denim Alert:























Some overalls have straps with hooks that can damage the drum of your washing machine or other garments during the wash. To minimize the risk, place hooks in the pocket and fasten with safety pins.

Vacations: unplug the appliance:

It is recommended that you should unplug the machine from the socket and turn off the water supply. Leave the door ajar to allow air circulation to the drum and the door gasket area. This will prevent unpleasant odors.

UNDERSTANDING FABRIC CARE LABELS

The symbols on labels of your garments will help you in choosing the suitable wash program, the right temperature, wash cycles, and ironing methods. Please review the chart below.

Machine Wash Cycle	 Standard	 Permanent Press/ wrinkle resistant	 Delicate/ Gentle	 Hand wash	 Do not wash	 Do not wring
Water Temp.	 Hot (50°C/120°F)	 Warm (40°C/105°F)	 Cold/Cool (30°C/85°F)			
Tumble Dry	 Dry	 Normal/ Cotton Heavy Duty	 Permt Press/ wrinkle resistant	 Delicate/ Gentle	 Do not tumble dry	 Do not dry
Special Instructions	 Line dry/ Hang to dry	 Drip dry	 Dry flat	 In the shade		
Bleach Symbols	 Bleach	 No-chlorine bleach	 Do not bleach			

WINTERIZING

How to winterize for cold weather

- 1) Pour 2 cups of RV type Antifreeze in soap dispenser.
- 2) Select WINTERIZE cycle on knob and press START. Machine will Rinse & Spin.
- 3) Open coin trap once cycle is finished and drain out remaining water.
- 4) Shut off water at both faucets and disconnect water inlet hoses from faucets and drain

MAINTENANCE

Your Washer- Dryer has been designed to operate with easy maintenance.

Follow these simple maintenance procedures to obtain optimum performance:

1. Ensure that your machine was installed according to the correct installation procedures detailed in this Manual.
2. Do not use solvents either to clean the machine or to wash clothes.
3. Keep the inside of the detergent dispenser clean.

Cleaning the coin trap

- Switch off the Washer
- Open the service flap. (bottom right corner)(Fig.11)
- Carefully unscrew the coin-trap cover. **Warning: Some residual water will flow out. (Approx. 1 Cup)**(Fig.12)
- Remove foreign objects/fluff from inside and clean the interior. (Fig.13)
- The pump impeller wheel located behind the water filter, must be able to rotate. Remove detergent residue and fluff from the pump cover thread and pump housing.
- Insert the coin-trap cover and screw tight.
- Insert and close the service flap.

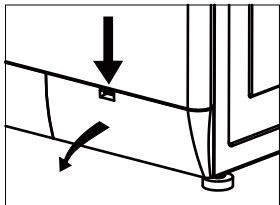

(Fig.11)

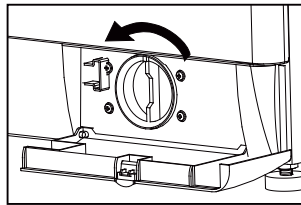

(Fig.12)

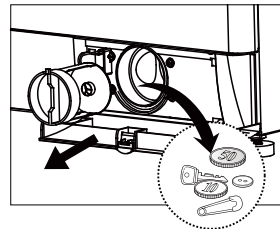

(Fig.13)

Cleaning the Detergent drawers and Recess

- Press release lever on the inside of the drawer and pull it out. (Fig. 14)
- Remove the cap from the Fabric Softener compartment.
- Wash all of the parts under running water.
- Clean the drawer recess with a small brush. (Fig.15, Fig.16)
- Reinsert the cap (Pushing it firmly into place).
- Push the drawer back into place.
- Run a rinse program without any laundry in the drum.

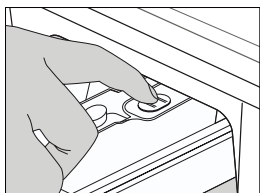

(Fig.14)

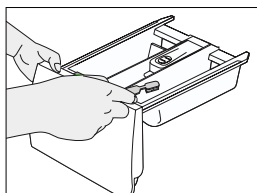

(Fig.15)

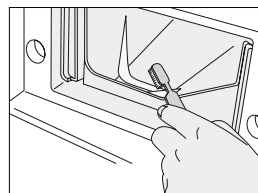

(Fig.16)

Cleaning the exhaust fan and duct

- In Vent Dry Mode, the exhaust fan and exhaust duct should be cleaned periodically atleast once a year to prevent lint build-up.

STAIN REMOVAL CHART

Blood

Rinse or soak fresh stain in cold water. Work detergent into any remaining stain. Rinse. If stain persists, put a few drops of ammonia on stain and repeat detergent treatment. Rinse. If necessary bleach.

Burn Marks

Rinse or soak in cold water. Work detergent into stain. Rinse. Bleach, if necessary. Stain may be impossible to remove

Candle Wax

Scrape off excess. Place stain between clean white blotters or several layers of facial tissues. Press with warm iron. Sponge with cleaning fluid. If dye spot remains, bleach.

Chewing Gum

Rub with ice to harden. Scrape off excess with dull blade. Sponge with cleaning fluid.

Chocolate or Cocoa

Soak 15 minutes in cold water. Rub detergent paste into stain, then rinse thoroughly. Launder in hottest water safe for fabric. If colored stain remains, sponge with hydrogen peroxide, rinse and launder.

Coffee or Tea

Soak fresh stains immediately in cold water. Then use bleach treatment with hottest water safe for fabric. Launder.

Cosmetics: eye shadow, lipstick, liquid make-up, mascara, powder, pancake make-up or rouge

Apply undiluted liquid detergent to stain, or dampen stain and rub in soap or detergent paste until thick suds are formed. Work in until stain is gone, rinse well. Repeat if necessary. If color remains, bleach if safe for fabrics.

Cream, Ice Cream or Milk

Sponge stain with cool water or soak stain in cool water for 30 minutes or longer. If stain remains, work detergent on spot then rinse. Bleach if necessary.

Deodorants and Antiperspirants

Wash or sponge stain thoroughly with warm water and detergent; rinse. If stain remains, bleach with hot sudsy water. Launder. You may be able to restore fabric color by sponging with ammonia. Rinse thoroughly.

Dye

Rinse or soak in cold water. Work detergent into stain. Rinse. If necessary, bleach. Stain is not always possible to remove. A commercial color remover may also be used.

Egg or Meat Juice

Rinse in cold water. If stain remains, sprinkle with meat tenderizer, let stand 15-20 minutes. If stain still remains, sponge with cleaning fluid or diluted bleach. Launder in hot water. The use of hot water first may set stain.

Fabric Softener Stain

Rub with bar soap until stain has lightened. Rinse thoroughly. Launder. Rubbing alcohol is sometimes effective in the color of the garment can take it. Launder. If desired, dry cleaning can be used.

Felt tip pen

Spray spot with cleaners suitable to this purpose. Sponge stain thoroughly. Rinse with cold water. Reapply cleaner if necessary .

Fruit, Wine

Soak fresh stains immediately with cool water. Then use bleach treatment with hottest water safe for fabrics. Launder.

Grass

Work detergent into stain. Sponge with denatured alcohol. Bleach, if necessary.

Grease or Oil

Scrape away excess. Rub detergent paste or a general purpose liquid household cleaner into stain, rinse with hot water. If stain remains, sponge thoroughly with a grease solvent. Dry. Repeat if necessary. To remove yellow stain, use a chlorine or oxygen bleach.

Ink

Some ball-point inks are set by water. First test a scrap of cloth. Sponge stain repeatedly with acetone, amyl acetate or rubbing alcohol. Hair spray is effective. Launder. Bleach if necessary. Use amyl acetate on triacetate, arnel, dynel and verel. Use acetone on other fabrics. NOTE: Some inks cannot be removed.

Ketchup

Scrape of excess. Soak in cold water 30 minutes. Pre-treat with a detergent paste. Launder.

Mildew

Brush off surface growth to keep mold spores from spreading. Dip article into solution of ½ cup bleach per 1 gallon of cool sudsy water for 5 to 10 minutes. Rinse well. Launder.

Mud

Let stain dry; then brush well. Rinse repeatedly in cool water until mud comes out. Launder. (Hot soaps suds set a red or yellow clay stain).

Mustard

Soak in hot detergent water for several hours. If stain remains, bleach.

Nail Polish

Treat while fresh, scraping or wiping off as much as possible, before it dries. Place stain face down on white paper towels. Sponge back of stain acetone (nail polish remover) or sponge with denatured alcohol and a few drops of household ammonia. Sponge stain frequently. Launder with water at temperature suitable for fabric. *Do not use acetone on acetate, arnel, dynel or rayon.*

Paint

Sponge or soak in turpentine or solvent recommended as a thinner on label. Launder.

Perfume

Rinse in cold water. Rub undiluted liquid detergent or a detergent paste into stain. Rinse. If stain remains, bleach.

Perspiration

Wash or sponge stain thoroughly with warm water and detergent paste. If perspiration has changed the color of the fabric, restore it by treating with ammonia or vinegar. Apply ammonia to fresh stains; rinse with water. Apply vinegar to old stains; rinse with water.

Rust and Iron

Apply commercial rust remover, Rinse. Or, if safe for fabric, boil stained article in solution of 4 teaspoons of cream of tartar to 1 pint water.

Shoe Polish

Scrape off as much as possible. Pre-treat with a detergent paste; rinse. If stain persists, sponge with rubbing alcohol (1 part to 2 parts water) or turpentine. Remove turpentine by sponging again with warm detergent solution or with alcohol. Bleach if necessary.

Soft Drinks

Sponge with cold water, some stains are invisible when they have dried, but turn brown when heated and may be impossible to remove.

Tar and Asphalt

Act quickly before stain is dry. Sponge with grease solvent or turpentine. Launder.

Urine

Soak in cool water. If stain is dry, work a detergent paste into the spot then rinse. If necessary, bleach.

TROUBLESHOOTING

In most cases, when your washer-dryer fails to work, the problems arising can be easily solved without having to call for a technician. Before calling for assistance, always check these points.

Does not start

- Is the plug correctly inserted into the socket?
- Is there electricity in the house?
- Is the door closed properly?
- Is the start button pressed?
- Is the Washer knob in the correct position for the cycle to start?
- Do any other devices work on that particular Socket?

Does not fill with water

- Is the hose correctly connected to the faucet?
- Is the water supply turned on?
- Is there sufficient water pressure?
- Is the faucet filter clean?
- Is the inlet hose kinked?

Continuously fills and drains water

- Is the drain hose positioned too low?
- Check that the inlet hose is not connected at a height more than 40 inches above the floor.

Does not drain or spin

- Does the selected program incorporate water draining?
- Is the drain pump clogged?
- Is the drain hose kinked?
- Is the coin trap clean?

There are too many suds in the drum

- Is High Efficiency (HE) detergent being used? It is recommended to use HE detergent.
- Is the correct amount of detergent being used?

Vibrates during the spin cycle

- Have all shipping rods been removed during installation?
- Has the machine been leveled correctly?
- Is there enough space between the machine and adjacent units?
- Is the machine loaded evenly?
- Is the machine installed on carpet or on a wooden floor?

Leaks

- Is the metal ring of the inlet hose properly attached?
- Is the detergent dispenser obstructed?
- Is the drain hose inserted correctly into the drain?

No drying

- Is the dryer knob in the correct position for the drying cycle ?
- Is drying cycle selected (Time Dry/Sensor Dry) ?

TROUBLESHOOTING

Not drying efficiently

Is the end of the drain hose under water?

Is the drain pump obstructed?

Is the drum overloaded?

Is the cold water faucet open?

Is fabric softener being used?

Condensation at soap dispenser

Slight condensation can occur at soap dispenser and will evaporate.

This is normal

DIAGNOSTIC MENU

Code	Description	Component	Part #
E1	Door not closed properly	Door Switch	1108
E2	Not Draining out water	Drain Pump	1107
E3	Not filling in with Water	Cold water valve Hot water valve	1132 1135
E4	Overfilling	Pressure Switch	1140
E5	No Tumble/High Speed spin	Main motor Electronic Module	2201 6638
E6	No communication between Display board and EM	Communication Cable	6639
E8	Not Drying properly	Temp. sensor (@rear-bottom of tub)	6605-A
E9	Not Drying properly	Temp. sensor (@front of heater housing)	6605-B
E10	Overfilling	Water level sensor	4448
E11	Not Drying properly	Temp. sensor (near the blow fan motor)	6605-C
E12	Not Blowing Hot Air into the Tub	Fan Motor	6604
E13	No Heat	Heating Element B Heating Element A	3308 3313

To Order parts : www.ApplianceDesk.com/Parts