

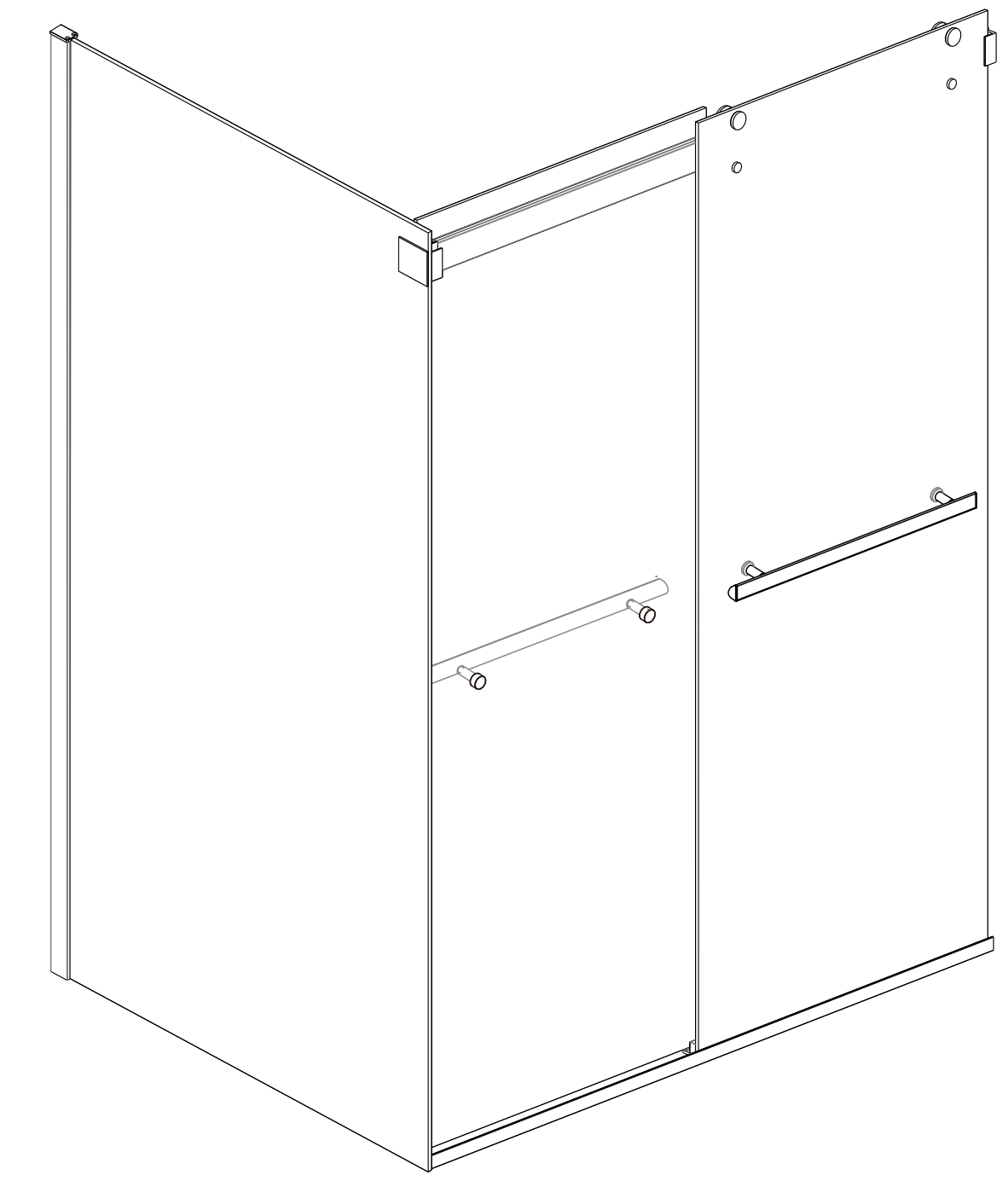

Vinnova Inc.

INSTALLATION SPECIFICATION

Item No.	301048+36P-BG
Combination	301048-BP-BG + 301036-SP-BG
Description	By-pass&Side Panel
Overall Dimensions	36"x48"x76"(with tray)
Installation Size Range	35"-35 4/5" & 44 7/10"-48 6/10"(shower door only)
Profile Color	Brushed Gold
Glass Thickness	8/25"
Glass Color	Transparent&Easy clean
Gross Weight	84 LBS & 119 LBS
Certifications	ANSI Z97.1-2015



Spezia
By-pass&Side Panel

All measurements are approximate. Measurements may vary +/- 1/25".

