

One-piece toilet installation instructions

PREPARATION TOOLS

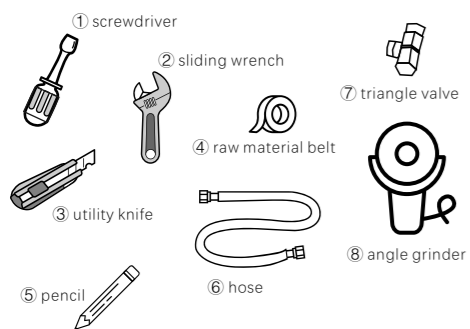

DIMENSIONING

(unit:mm)

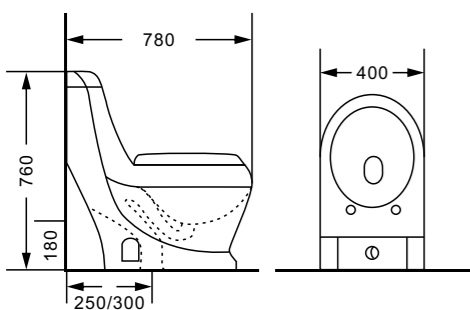

INSTALLATION STEPS

1. Install the toilet cover in advance.

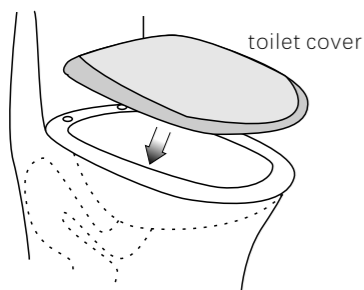

2. Measure the hole distance.

Measure the distance from the wall to the center of the sewage outlet. The toilet hole distance must be the same as the installation position.

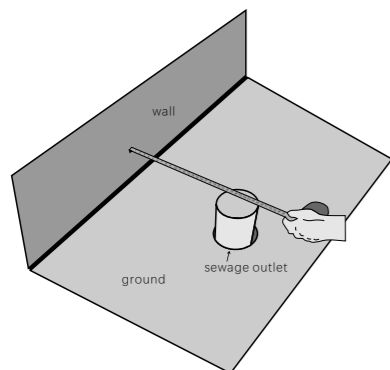

3. Cut the sewage pipe above the ground to 0.5-1cm from the ground.

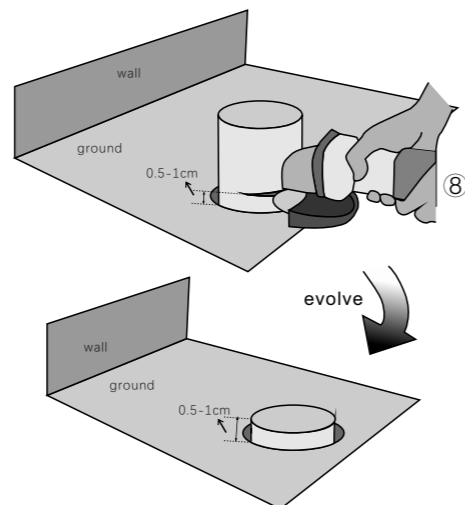

4. Clean the toilet installation location and the side to ensure that the toilet installation location is dry and dust-free.

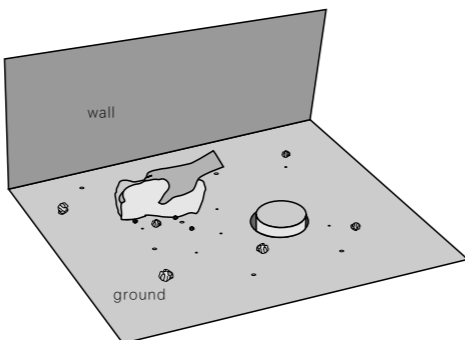

5. Install the water inlet valve.

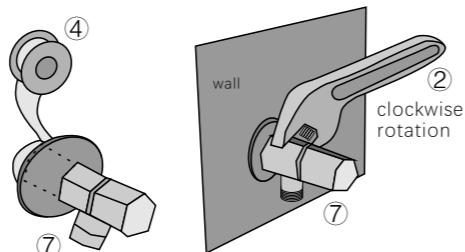

6. Draw lines and glue.

Put the toilet in the desired installation position. Remember to align the position of the toilet sewage outlet and the ground sewage outlet. Fine-tune the orientation of the toilet so it fits snugly.

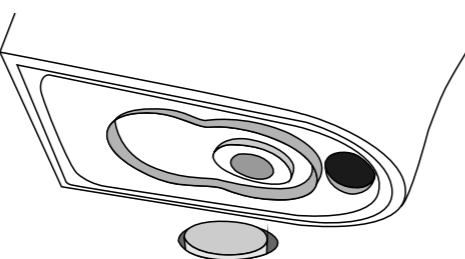

Use a pencil to draw a line on the floor along the bottom of the toilet. After drawing the line, lift the toilet.

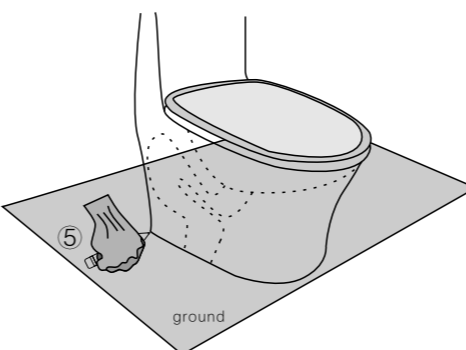

Use "Ceramic Waterproof Sealant" to glue the front line.

Note: When applying sealant, be sure to measure 2-3mm online and evenly apply glue.

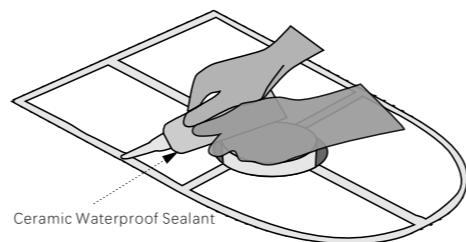

7. Install the water inlet pipe in advance. Pay attention to whether the water inlet system is loose.

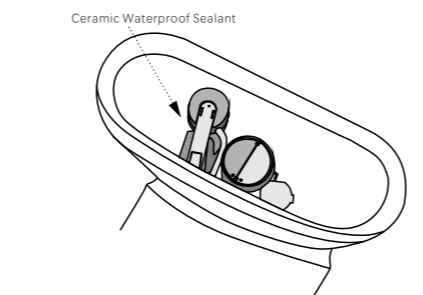

Install the sealing flange ring on the toilet drain.

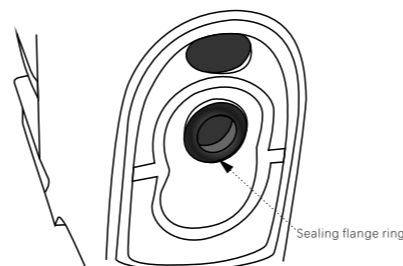

8. Carefully place the toilet in place of the sealant.

Make small adjustments to make the toilet flat and straight.

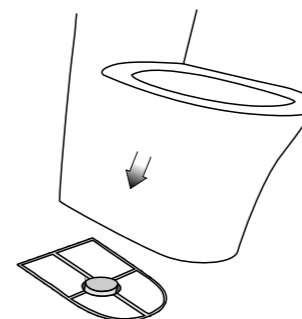

Then press a few times to ensure no traces.

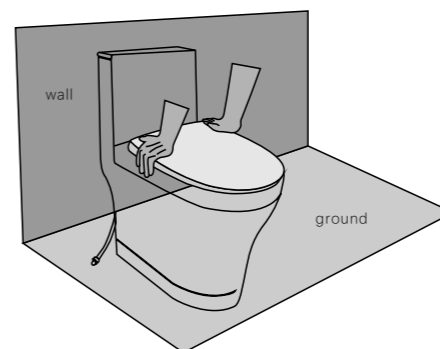

Then use sealant to glue the bottom of the toilet again. Clean up and wipe off excess sealant for an aesthetically pleasing fit.

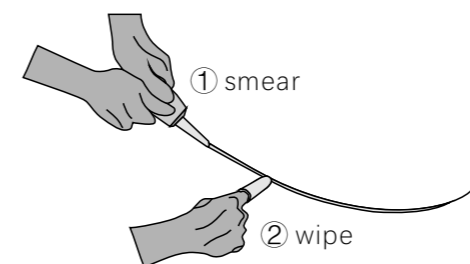

9. Connect the hose to the triangle valve.

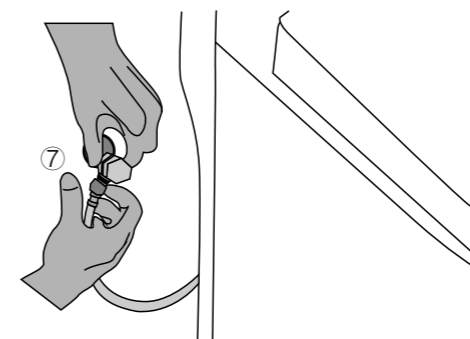

10. Debug.

Turn on the water inlet switch of the triangle valve and test the water to see if the flushing is smooth.

Tighten triangle valve

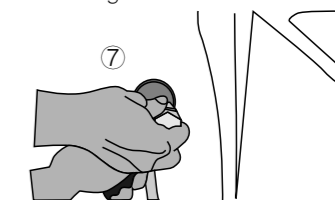

Check water intake

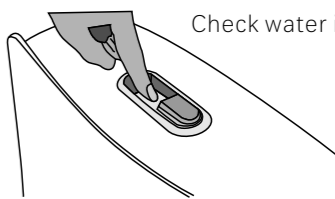

Check for smooth flushing

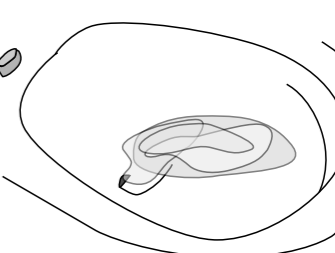

11. Cover the toilet with a reusable bag to keep the toilet dry.



Toilet can be used after 48 hours.

