

ASSEMBLY INSTRUCTION

ARMLESS CHAIR

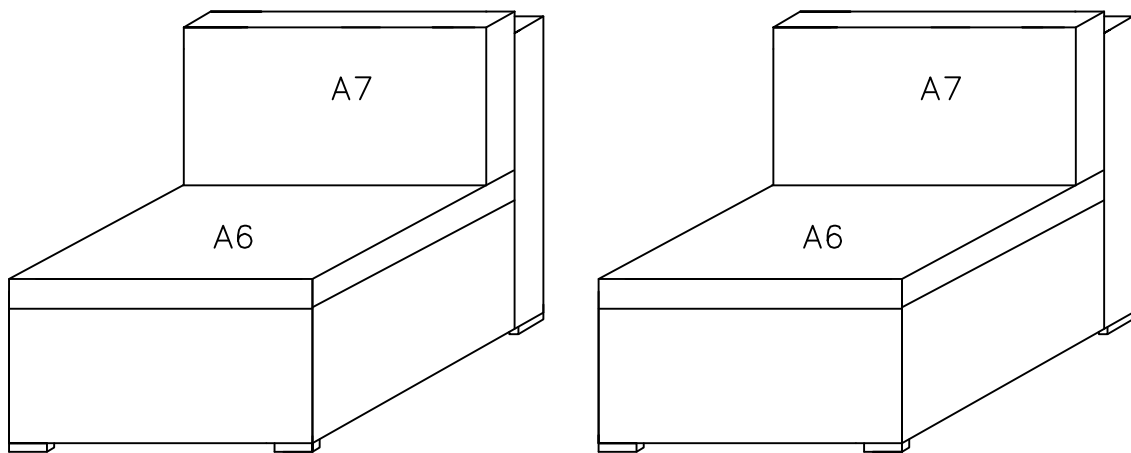

Thank you for choosing Beefurni!

Our goal is to provide high quality outdoor furniture with outstanding customer service at an affordable price.
Please let us know how we are doing!

Problems?

Please kindly contact us 24/7 via email support@beefurni.com
As a valued customer, your satisfaction is our #1 priority!

Other products?

Please kindly find our more products at website www.beefurni.com

PART LIST

D1x2

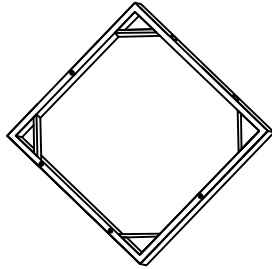

Armless Chair Seat Frame

D2x2

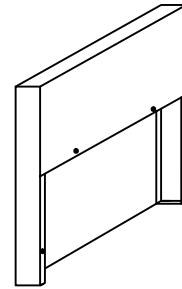

Armless Chair Back Frame

D3x2

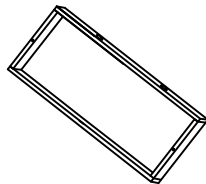

Armless Chair Leg Frame

C5x4

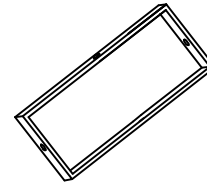

Side Frame

A6x2

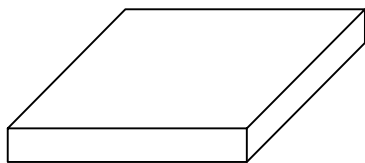



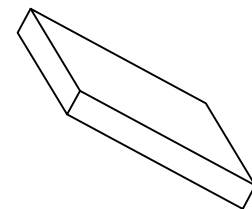

Seat Cushion

A7x2

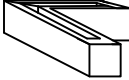
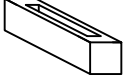

Back Cushion

PART LIST

<p>Lx4</p>  <p>Foot L Shape</p>	<p>Ix4</p>  <p>Foot I Shape</p>
<p>Nx36</p>  <p>Bolt M6x30</p>	<p>Ox20</p>  <p>Washer 15x6x1</p>
<p>Px1</p>  <p>Allen Key</p>	

ARMLESS CHAIR

Step 1

Connect D1 with D2 by bolt N, washer O and allen key P

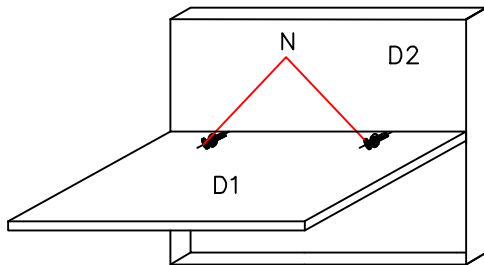

Step 2

Connect parts from step 1 with D3 by bolt N, washer O and allen key P

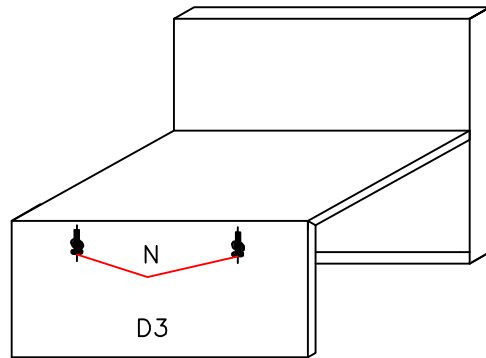

Step 3

Connect parts from step 2 with C5 by bolt N, washer O and allen key P

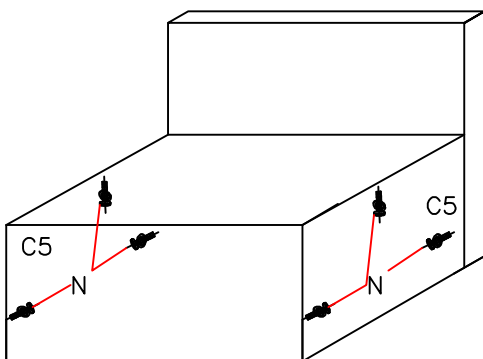

Step 4

Connect parts from step 3 with 2 foot L shape and 2 foot I shape bolt N and allen key P

