



PIONEER INDUSTRIES, INC.
 3325 S. Garfield Ave.
 Commerce, CA 90040
 (800) 338-9468
 www.pioneerind.com

INSTALLATION

Tools:



Adjustable Wrench



Plumbers Putty



Teflon Tape



Rags

Model Number: 3BR4X0, 3DM200, 3DM300



Warnings and Notes:

Check with local plumbing code requirements before installation.
 This product should be installed by a local listed plumber.
Do not use plumbers putty on threads.

Installation Steps:

Two Handle Lavatory Widespread Faucet

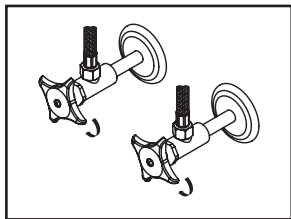

(1) Shut off water supplies. Remove old faucet. Clean mounting surface in preparation for new faucet.

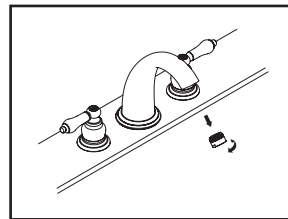

(6) Important: After installation is complete, remove aerator. Turn water supplies on and allow both hot and cold water to run at least one minute each. While water is running, check for leaks. Turn off water and replace aerator.

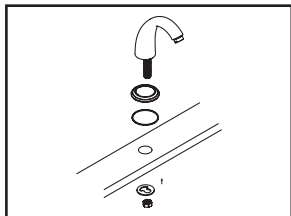

(2) Ensure gasket is under spout escutcheon, place spout escutcheon under the spout. Place spout in position on the sink, slide mounting bracket through spout shank from underneath the sink, thread mounting nut onto spout shank and tighten the mounting nut.

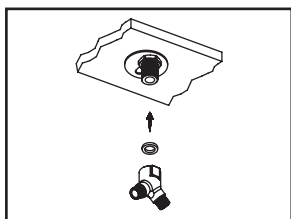

(3) Place washer inside the Y connector, thread Y connector to the spout shank.

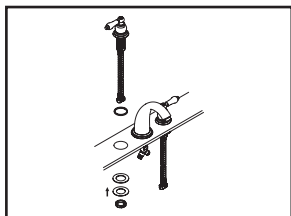

(4) With gasket inside valve escutcheon place side valves in position on the sink, ensure handles operation turn in correct direction, adjust escutcheon if necessary so bottom of the handle hub won't touch valve escutcheon when operate the handle. Slide rubber washer, steel washer and thread locknut onto side valve from underneath the sink.

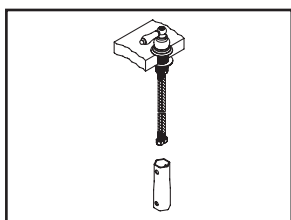

(5) Tighten mounting nut onto side valve with help of 1-11/32" socket. Repeat the same procedure on the other side valve. Connect both cold and hot side valve outlet hoses to Y connector.

Pop-up Drain Installation:

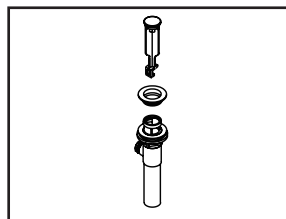

(1) Remove pop-up flange from body

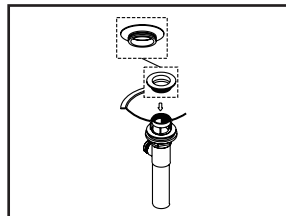

(2) Place a ring of putty on the bottom of flange.

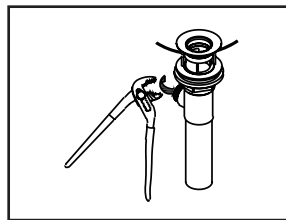

(3) Insert pop-up flange through drain hole and attach flange to body. Ensure the pop-up outlet faces towards the back of the sink. Tighten the locknut securely with a wrench. Do not overtighten.

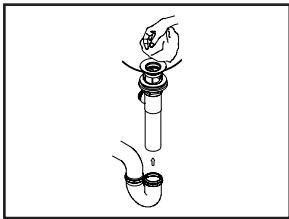

(4) Remove the excess putty. Connect the trap (check manufacturer's instructions for installation)

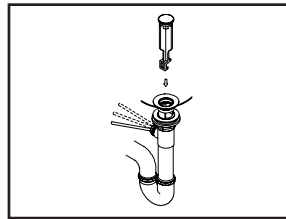

(6) Push pivot rod down, insert drain plug carefully. Test to ensure drain plug works properly.

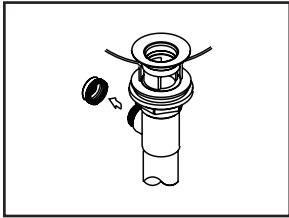

(5) Remove pivot rod nut from pop-up body, ensure the washers is in place, insert pivot rod, tighten pivot rod nut back to pop-up body.

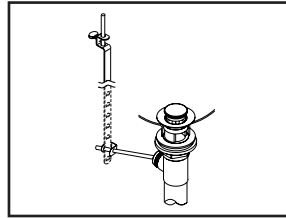

(7) Connect lift rod strap to pivot rod by using clip. Tighten the thumbscrew to connect lift rod strap to pop-up lift rod.

Exploded Drawing : (For 3BR4X0)

* Note: Please specify finish/color when ordering.

	ITEM #	DESCRIPTION
A	X-1900009C,H*	Lever Handle-C, H (For 3BR400)
A	X-1900010C,H*	Porcelain Lever Handle-C, H (For 3BR410)
B	X-1900011C,H*	Porcelain Cross Handle-C, H (For 3BR420)
C	X-1900012C,H*	Beaux Lever Handle-C, H (For 3BR430)
D	X-4900024	3/32" Allen Wrench(For 3BR430)
E	X-4900063*	Valve Escutcheon and Gasket
F	X-5900001	Mounting Kit
G	X-4900022	Bonnet Nut
H	X-3900002C,H	Ceramic Stem-Cold,Hot
I	X-4300011	"Y" Connector & Washer
J	X-5300003	Spout Mounting Kit
K	X-2300009*	'J' Style Spout
L	X-6300008*	Brass Pop-Up Drain Assembly
1	X-4900042C, H*	Button-C, H (For 3BR400, 3BR410)
2	X-4900061	Handle Screw (For 3BR400, 3BR410, 3BR420)
3	X-4900062C, H*	Button-C, H (For 3BR420)
4	X-4900002	3/32" Allen Screw (For 3BR430)
5	X-4900081*	1.5 GPM Aerator
6	X-4300035*	Escutcheon and Gasket
7	X-4300045*	Pop-up Lift Rod

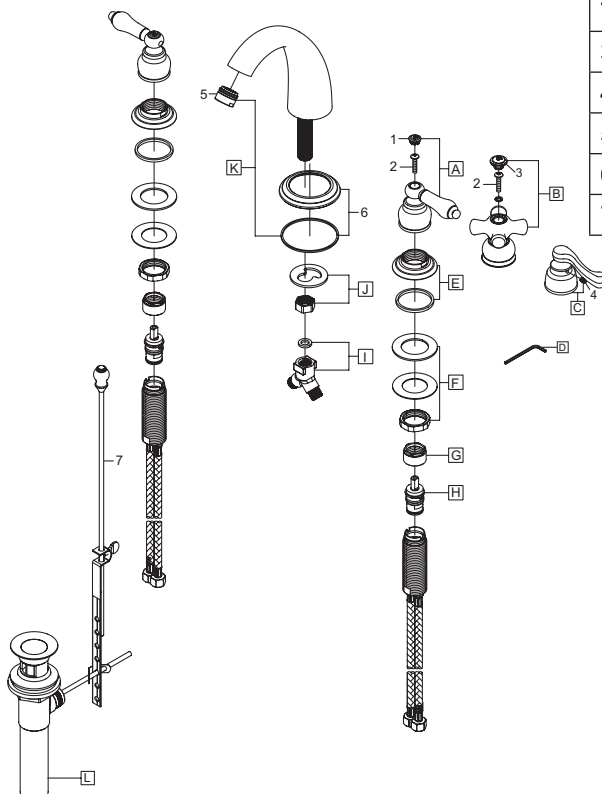

For more care information or trouble shooting inquiries about your Pioneer product, please call:
Pioneer Industries, Inc. (800) 338-9468
 Monday-Friday 8AM to 8PM EST (5AM to 5PM PST)
www.pioneerind.com

Exploded Drawing : (For 3DMX00)

* Note: Please specify finish/color when ordering.

	ITEM #	DESCRIPTION
A	X-4900024	3/32" Allen Wrench
B	X-1900005*	DM Lever Handle
C	X-4900023*	Escutcheon & Gasket
D	X-5900001	Valve Mounting Kit
E	X-4900022	Bonnet Nut
F	X-3900002C,H	Ceramic Stem-Cold,Hot
G	X-2300001*	DM 'C' Spout (For 3DM200)
H	X-5300002	Spout Mounting Kit (For 3DM200)
I	X-4900020	'Y' Connector & Washer (For 3DM200)
J	X-2300002*	DM 'J' Spout (For 3DM300)
K	X-5300003	Spout Mounting Kit (For 3DM300)
L	X-4300011	Y' Connector & Washer (For 3DM300)
M	X-6300012*	Brass Pop-Up Drain
1	X-4900002	3/32" Allen Screw
2	X-4300063*	1.5 GPM Aerator (For 3DM200)
3	X-4300010*	Spout Escutcheon & Gasket (For 3DM200)
4	X-4900081*	1.5 GPM Aerator (For 3DM300)

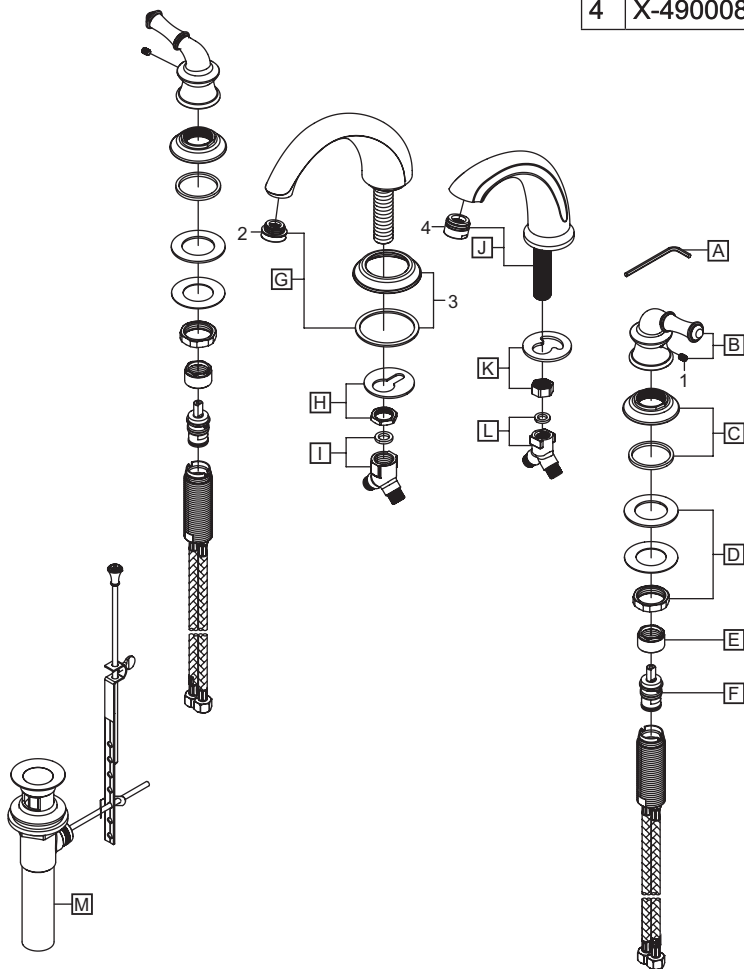

For more care information or trouble shooting inquiries
 about your Pioneer product, please call:
Pioneer Industries, Inc. (800) 338-9468
 Monday-Friday 8AM to 8PM EST (5AM to 5PM PST)
www.pioneerind.com

