

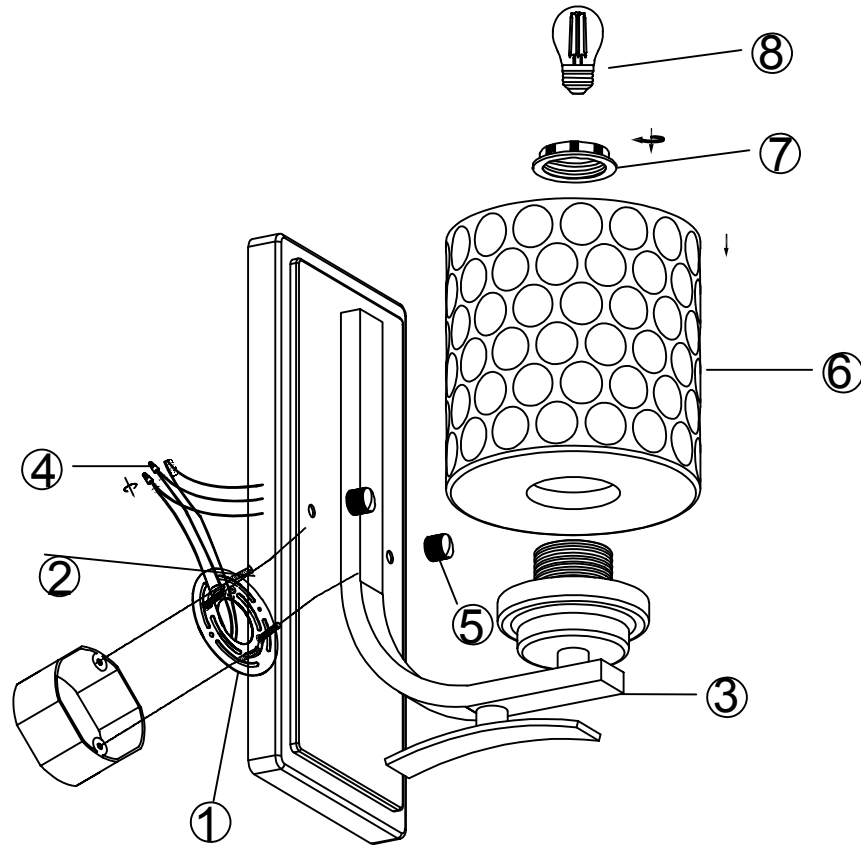



ITEM NO.: S1001CH-C01
 FIXTURE ASSEMBLY STEPS:



DESCRIPTION	PICTURE	CODE	QTY
Mounting Plate with +Screws+Canopy Nut		1/5	1/SET
Mounting Box Screw		2	2 PCS
P3 Wiring Cap		4	2PCS
Glass Shade		6	1PCS
Lamp Body		3/7	1 SET

WARNING-If any special Control Devices are used with this Fixture, Follow the instructions Carefully to assure fun compliance With N.E.C. requirements. if there are any questions, contact a Qualified Electrical Contractor.
 CAUTION-All glass is fragile, use care when handling Glass component(s) and or Lamp(s).
 WARNING-This product contains chemicals know to the state of California to cause cancer, birth defects and /or other reproductive harm. Thoroughly was hands after installing, handling, cleaning. or otherwise touching this product

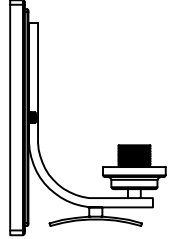
CANOPY MOUNTING & WIRE CONNECTION ASSEMBLY STEPS:

Attach(N),(P) to achieve overall desired length.
 Una(N),(P) para lograr la longitud deseada.
 Joignez(N),(P) pour obtenir la Longueur voulue.

FIXTURE ASSEMBLY STEPS:

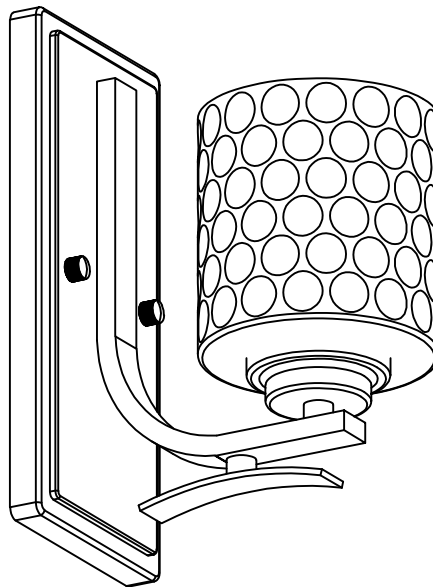
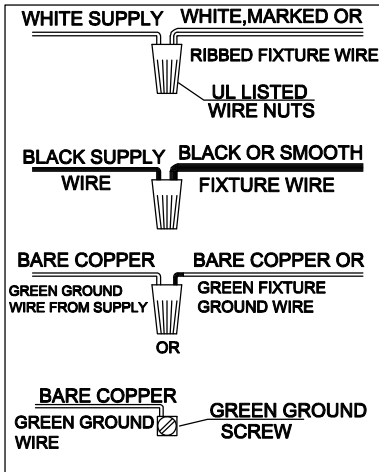

ITEM NO.: S1001CH-C01

**110-120V/60HZ
 E26 1*MAX60W TYPE A
 (Do not contain light bulb)**

1. AC110-120V,50-60Hz. The Max. lamps is 60W TYPE A Bulb.
2. Avoid to scratch the surface of lighting and the wires when install it.
3. Connecting the neutral wire with the white wire, the live wire with the black wire, the earth wire with the earth symbol(L-L, N-N).
4. Don't install it to the ceiling before It's completely dry. the surrounding around must be ventilated and dry.
5. Keep away from acid,basicity objects and gases,clean with soft cloth,water washing is not allowed.
6. Be careful when you install glass lamp shade
7. The lighting must be installed by professional electrician and used indooronly.
8. Please keep attention to cut off the power supply when installing,cleaning and replacing bulb.