

T Ö V

**Eden Bed**  
**TOV-B18/TOV-B26/TOV-B27/TOV-B28/TOV-B29**  
**TOV-B30**

F U R N I T U R E





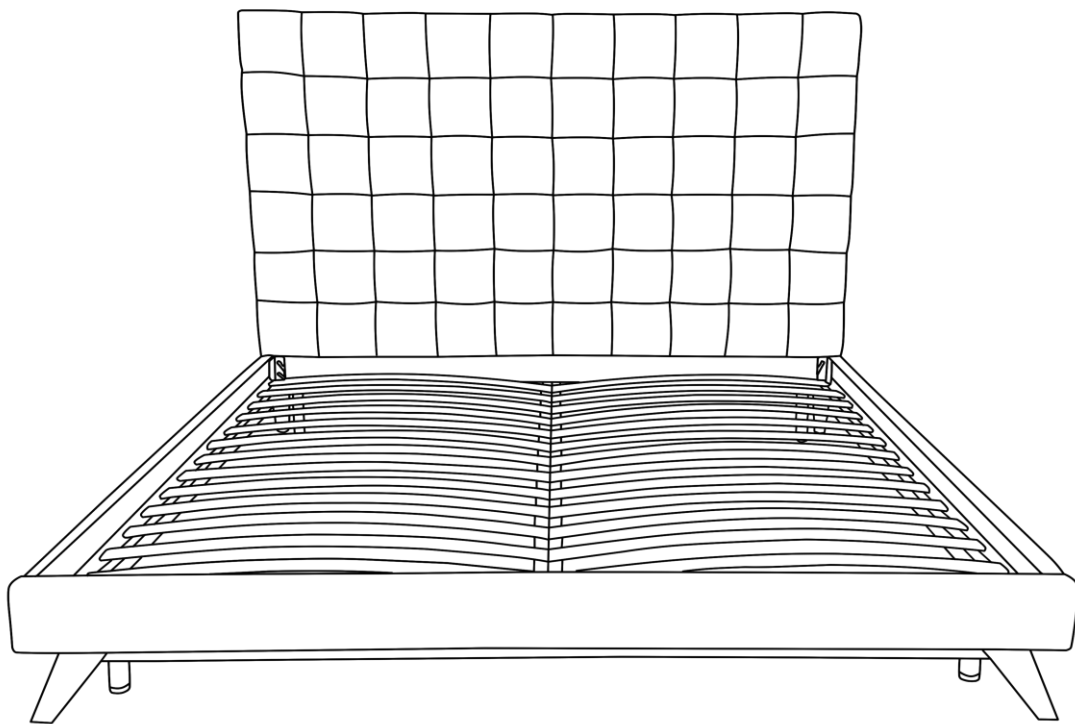

# EDEN

---







## ASSEMBLY INSTRUCTIONS

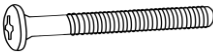

## PARTS LIST

LABEL	PICTURE	DESCRIPTION	QTY
<b>A</b>		<b>HEADBOARD</b>	<b>1</b>
<b>B</b>		<b>SIDEBOARD</b>	<b>2</b>
<b>C</b>		<b>FOOTBOARD</b>	<b>1</b>
<b>D</b>		<b>KEEL FRAME</b>	<b>2</b>
<b>E</b>		<b>BED SIDE LEG</b>	<b>2</b>
<b>F</b>		<b>KEEL FRAME SIDE LEG</b>	<b>4</b>
<b>G</b>		<b>KEEL FRAME MIDDLE LEG</b>	<b>2</b>

## HARDWARE

LABEL	PICTURE	DESCRIPTION	QTY
<b>H</b>		<b>Keel Frame Side Leg Screw</b>	<b>8</b>
<b>I</b>		<b>Fixed Clip</b>	<b>4</b>
<b>J</b>		<b>Keel Frame Middle Leg Screw</b>	<b>4</b>
<b>K</b>		<b>Keel Frame Middle Leg Screw</b>	<b>4</b>
<b>L</b>		<b>Middle Leg Screw Nut</b>	<b>8</b>
<b>M</b>		<b>Wrench</b>	<b>1</b>
<b>N</b>		<b>Keel Frame Side Leg Screw M8</b>	<b>8</b>

## BEFORE BEGINNING ASSEMBLY:



Read instructions cover to cover



Have two adults on hand for assembly



Do NOT assemble on flooring or carpet. Assemble on a clean non-marring surface (ex: packing foam)



Save all packaging until assembly is completed

---

## ASSEMBLY STEPS

---

### STEP 1

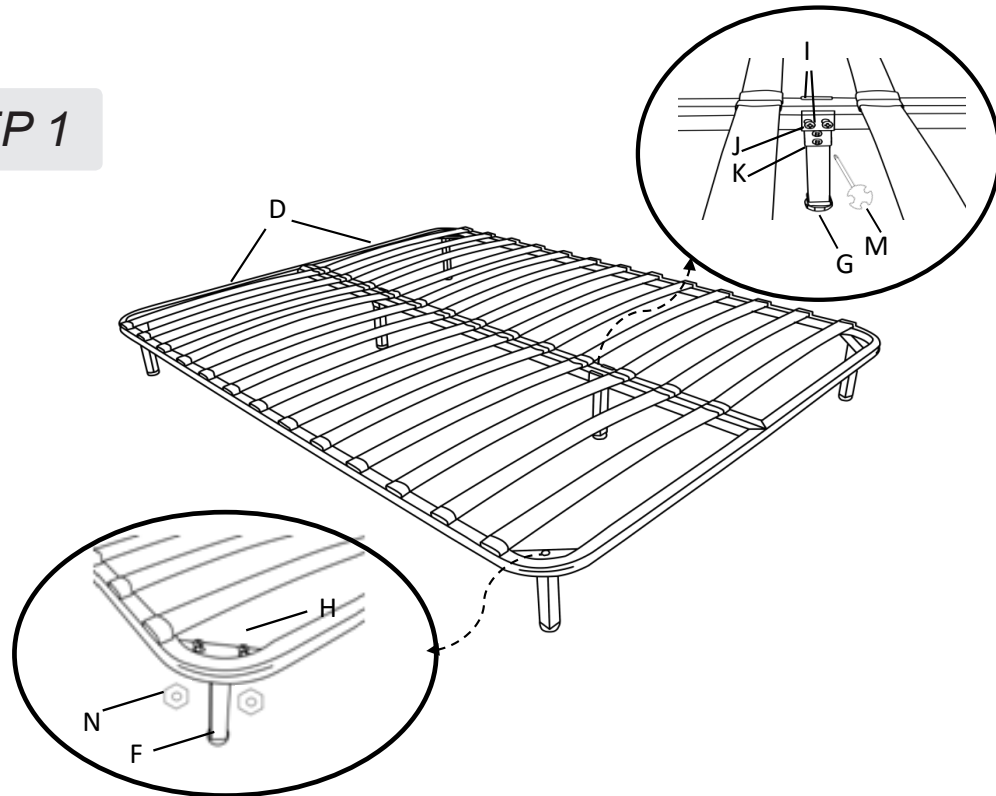

# ASSEMBLY STEPS

## STEP 2

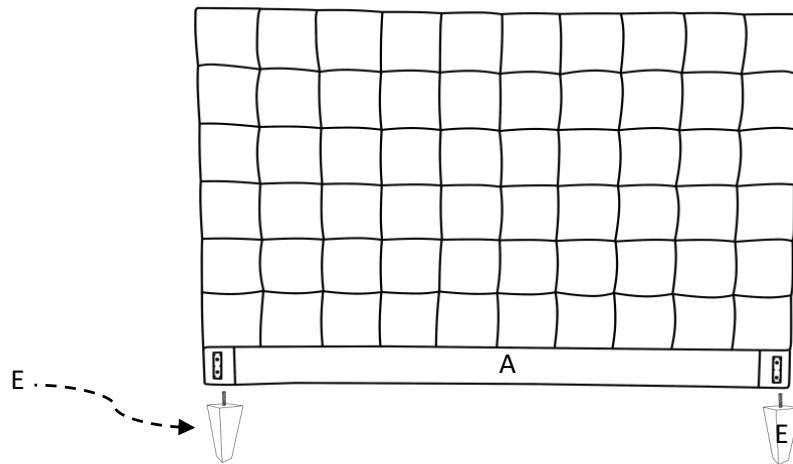

## STEP 3

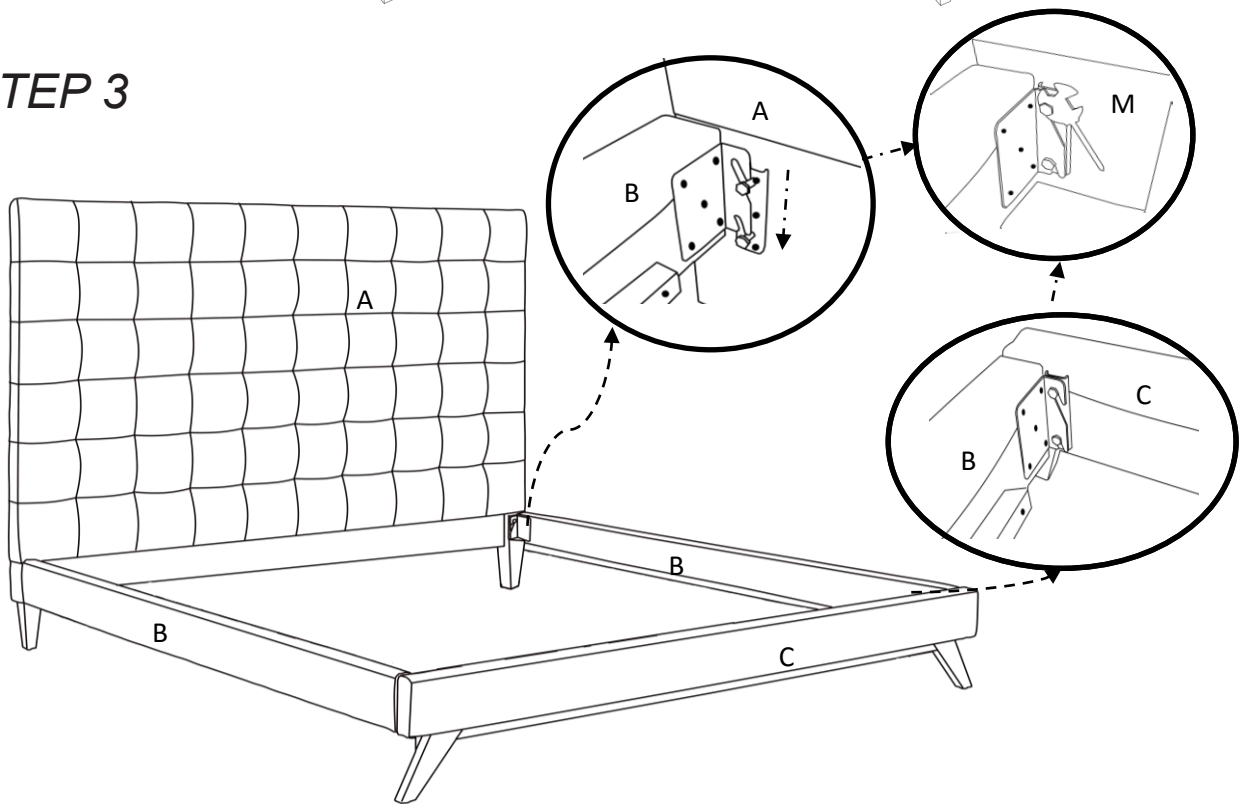

## STEP 4

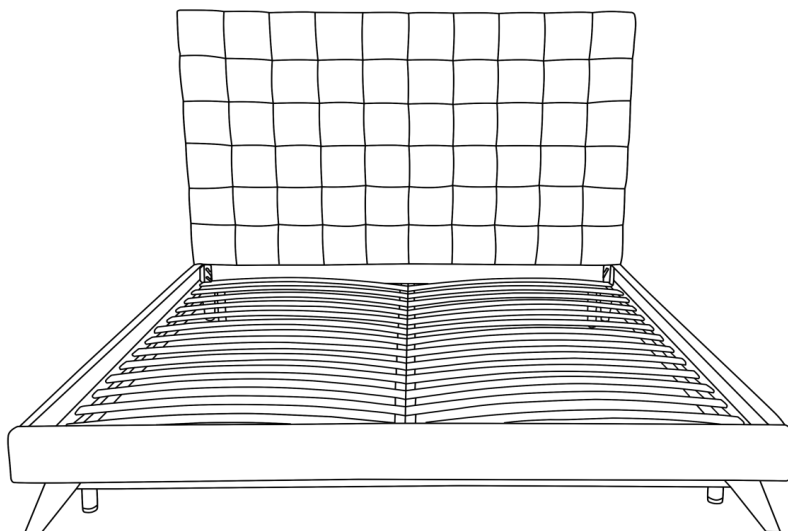

## **CARE & MAINTENANCE**



**Do not put hot items directly on furniture surface.**



**Do not clean furniture with harsh cleansers or polish.**



**Dust and pick up spills using a clean, non-colored, lint-free cloth.**



**Stains may be removed with mild soap solution and a damp cloth.**



**Do not place furniture under direct sunlight.**



**Do not place furniture near heating or cooling vents.**



**Do not write on furniture without a padded barrier to protect the surface.**



**Do not place furniture outside, for indoor use only.**