

Front View

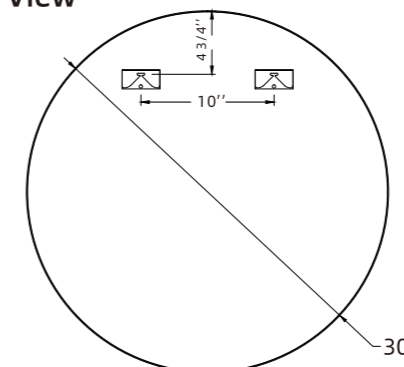

Back View



Side View

FEATURES

- 5mm Copper free mirror.
- PVC film backed.
- Mounting type: Vertically
- Energy Efficient and Long Lasting LED Lighting.
- 1Year Limited Warranty on Electronic Components.

LIGHTING:

- LED (Light-Emitting Diode).
- Defogger .
- Dimmable
- Color Temperature: 6000K .
- Power Source: Input: 110volts, 50/60HZ.
- IP44 rated.
- Brightness Lumen: 3280;
- Power Consumption :48Watts ;
- Energy saving LED lifetime approx 50,000 hours.
- UL certificated for electric power supply, defogger and LED strips.

Available Standard size:



- 24"x24"
- 30"x30"

Certification:



Manual Instruction

How to used Defogger Switch and Dimmer Switch ?

- 1) Short Touch Button  (<1s) to turn the task light on /off then long touch (>1s) to dimming from 15% to 100% and cycle.
- 2) Press the Button  to turn the defogger on and off.

Care & Maintenance

"NOTE": Use warm soap water and a soft ,damp ,lint-free cloth to clean the mirror.Wipe dry with another clean cloth .Glass cleaner can be used on the mirror surface when required .Avoid scourers ,abrasives and chemical cleaners as they can damage the glass and the frame .





In hard water areas ,limescale may deposit on the glass .Regular cleaning will minimize this problem.If this build-up becomes increasing difficult to remove ,apply a small amount of white vinegar on the area .

 Do not attempt to cut the glass .

 Do not hit the glass with hard or sharp article.

Installation Instructions

Please read follow warm tips before installation !

-  Power off electrical before installation. Use voltage detector to make sure. Verify the circuit breaker is turned off & lock it in case someone try to turn it on.
-  If you're NOT experiend in installing electrical wiring, then hire a professional electrician. Your safety is more important then saving a few dollars.
-  Avoid water at all times when working with electricity. Never touch or install any electrical equipment or circuits with wet hands.
-  Tools you will need: voltage tester, wire cutters, wire and cable strippers, needle nose pliers, continuity tester, and wire closure.
-  Wear Safety Glasses and Protective Clothing to protect you from sparks.

Installation Tools Needed

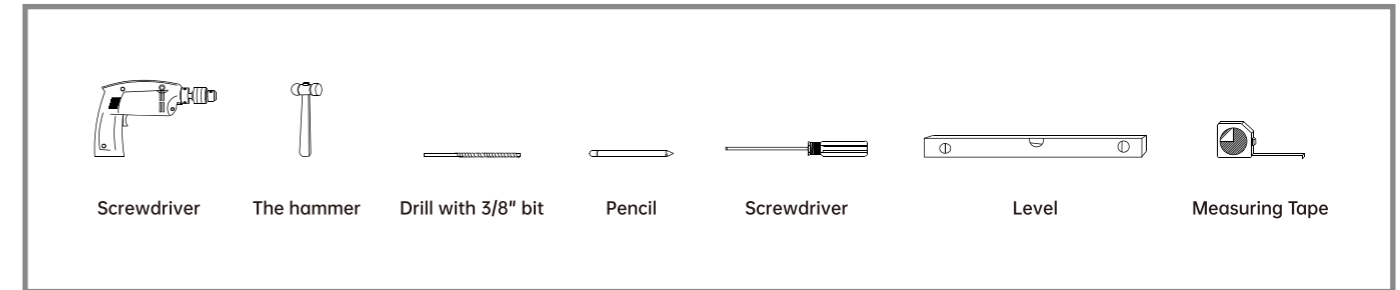

Installation manual

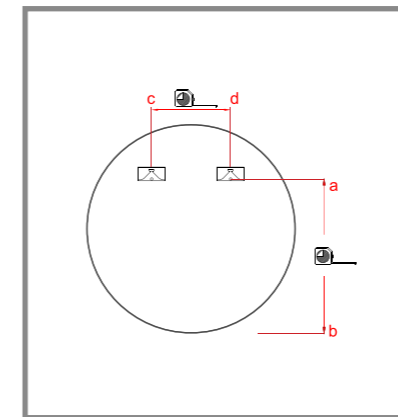

Step 01: Check the wall.Make sure that the wall is bearing walls that can support the Mirror's weight. Measure the width and height of the mirror back holes/hocks distance with a tape measure.

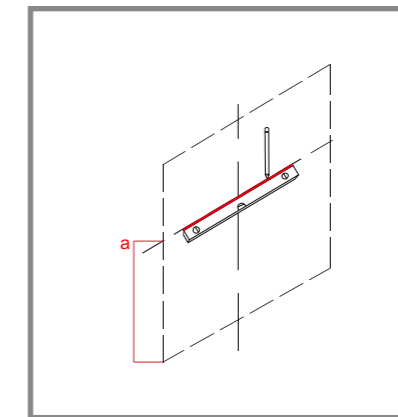

Step 02: Mark the punching position on the wall with a pencil. use level gauge make sure the hole is at the same level.

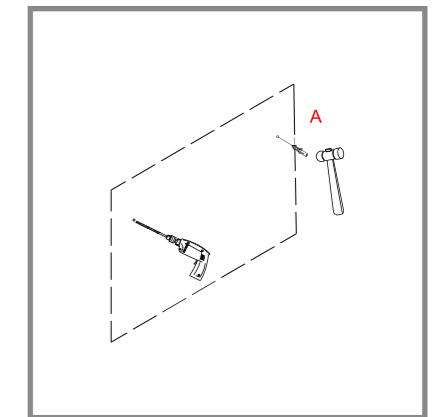

Step 03: Use impact drill punch holes in the marked center (6-8MM drill bit),the drilling depth is about 5CM.Use a hammer to drive the expansion screw into the drilled hole.

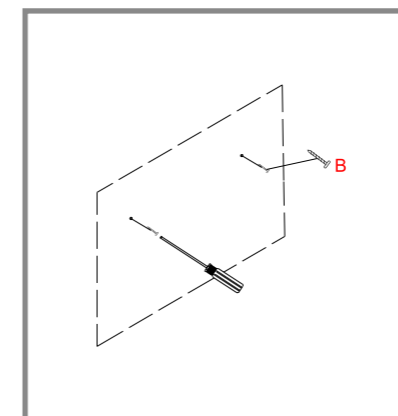

Step 04: Use screwdriver screw the screw into the expansion screw, tighten. And then leave a distance of about 5MM from the wall.

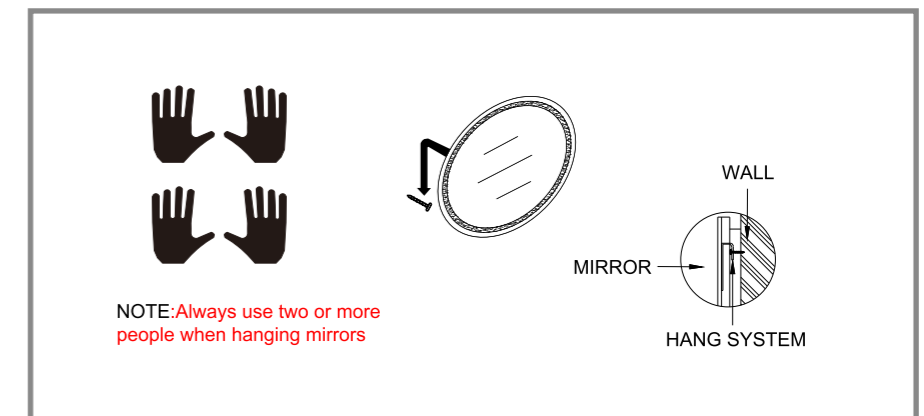

Step 05: Hand the mirror up with screw.

NOTE: Always use two or more people when hanging mirrors