





# INSTALLATION GUIDE

**SURFACE REQUIREMENT:** The tile need to be installed over very clean and sleek surface such as clean and sleek ceramic surface, glass surface, acrylic surface, melamine surface, stainless still surface, aluminium plate surface. Not all the latex / repainted walls can be installed directly, for latex / repainted wall, the 3M Spray Adhesive is recommended, please follow the instruction on the right handside.

-  **1** Clean the surface to be covered using a cleaning agent.  
Nettoyer la surface à couvrir avec un produit dégraissant.
-  **2** Draw a leveled guide line.  
Dessiner une ligne guide à niveau.
-  **3** Remove the plastic protector on the back of the tile. Ensure that the adhesive remains untouched.  
Retirer la pellicule à l'arrière de la tuile. Faire attention de ne pas toucher l'adhésif.
-  **4** Align the adhesive tile.  
Aligner la tuile autocollante.
-  **5** Install the tile. Overlap grout lines.  
Coller en superposant les lignes des joints.
-  **6** If needed, cut the tile.  
Si besoin, couper la tuile.

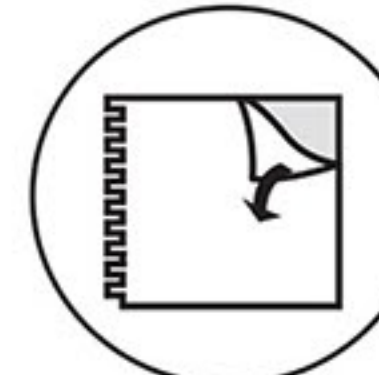
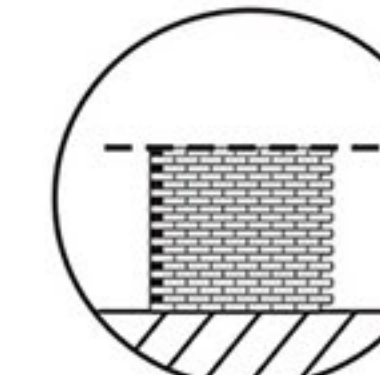
**IMPORTANT:** For the installation around a gas stove, please ensure that the following instructions are followed in order to avoid any direct contact between the tiles and the flames. If your stove does not have a back panel or metal cover, It is important to leave a space free of tiles. Do not install tiles less than 16 inches away from the top of the stove.

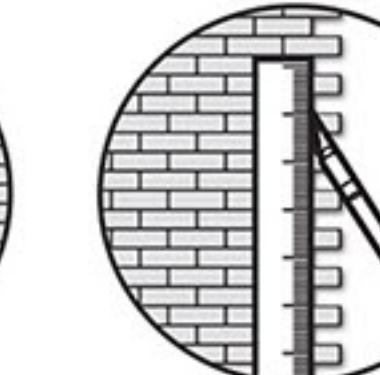
- Do not use these tiles in a shower enclosure, as this will affect the adhesive components of the tiles.
- Do not touch the adhesive on the back of the tiles, as this might weaken its performance.
- Do not use these as a countertop covering surface.

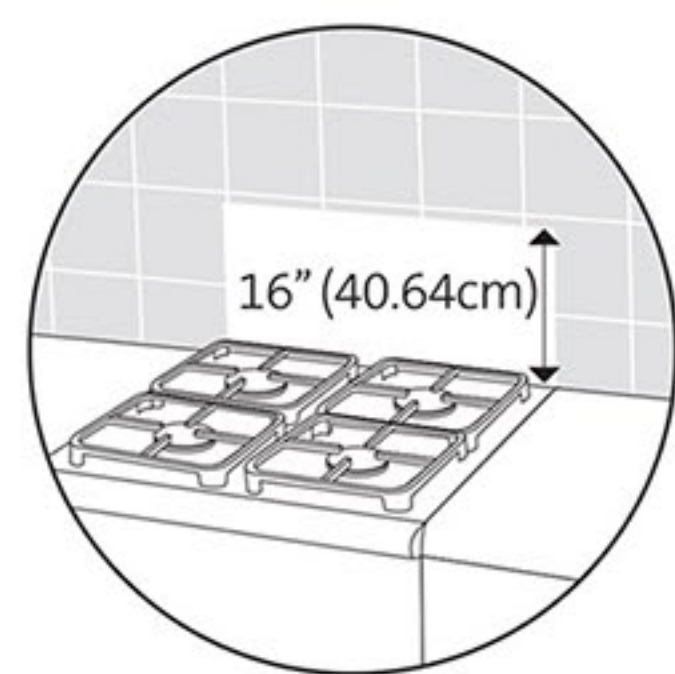

Gas stove WITH NO back control panel or metal cover.

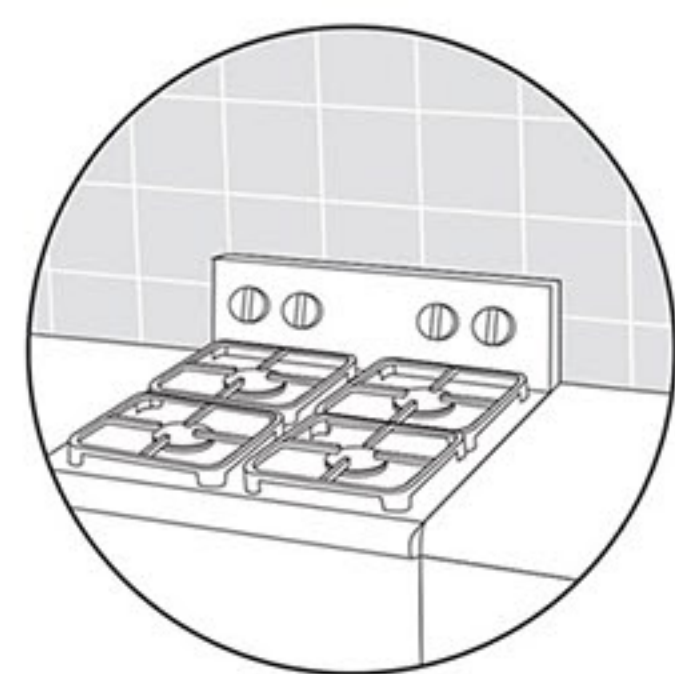



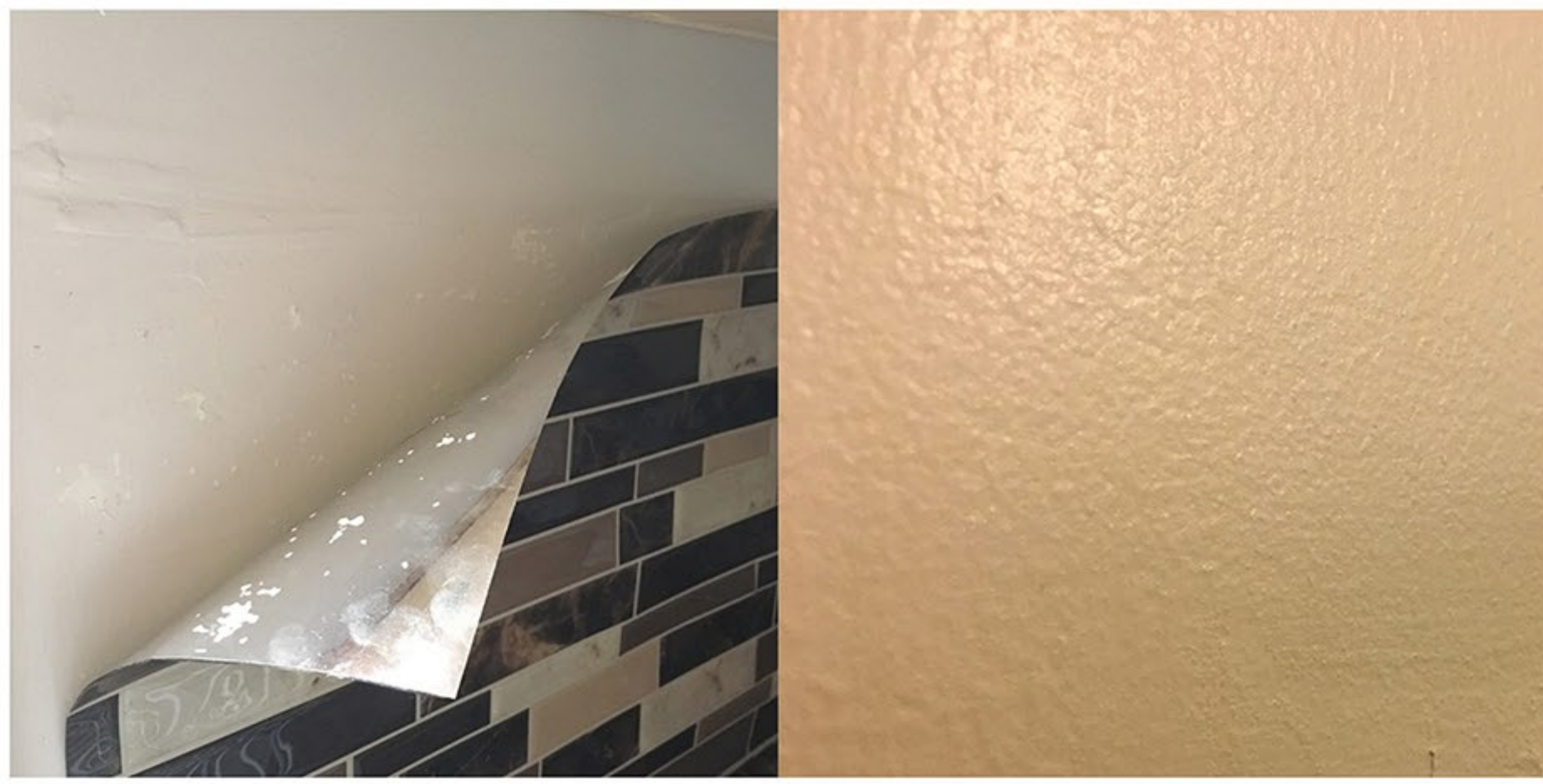

Gas stove WITH back control panel or metal cover.

# WARNING:

Not all the latex / repainted wall can be installed directly, we analyzed and found that over 95% of the complains about peeling off are because of installing directly over the latex wall or repainted wall. For latex / repainted wall, the best way is to try to stick one tile on the wall and check after 24 hours, if it doesn't peel off, it means it work; if not, please follow the instruction:



## FOR LATEX / REPAINTED WALLS, PLEASE FOLLOW THE INSTRUCTION:

-  **1** Sand the surface with sanding paper
-  **2** Clean the wall with damp cloth
-  **3** Wait until the wall is totally dry
-  **4** Spray the adhesive on the wall and stickers, spray more on the joint area.
-  **5** Peel and press the sticker over the wall

\* 3M Spray Adhesive is recommended for latex/painted wall, please go to [amazon.com](https://www.amazon.com) or [walmart.com](https://www.walmart.com) and search "3M spray adhesive" and you will find the product, or please buy on:  
 - Amazon: <https://www.amazon.com/dp/B000PCWRMC/>  
 - Walmart: <https://www.walmart.com/ip/19412027>