

# INSTALLATION AND CARE GUIDE

## WOODBIDGE<sup>®</sup> WHIRLPOOL & AIR BATHTUB B0030/BTS1606

Compliance with the following codes & standard:

- 2015 Uniform Plumbing Code<sup>®</sup> (UPC)
- 2018 International Plumbing Code<sup>®</sup> (IPC)
- 2018 International Residential Code<sup>®</sup> (IRC)
- CSA B45.5 / IAPMO Z124-2017- Plastic Plumbing Fixtures



**READ ALL INSTRUCTIONS BEFORE UNPACKING THE PRODUCT**

INSTRUCTIONS THAT, IF IGNORED COULD RESULT IN DEATH OR SERIOUS INJURY CAUSED BY INCORRECT HANDLING OR INSTALLATION OF THE PRODUCT. THESE INSTRUCTIONS MUST BE OBSERVED FOR SAFE INSTALLATION.

**CAUTION!**



**TWO PERSON LIFT REQUIRED**

**2 PEOPLE ARE REQUIRED TO LIFT AND DURING ENTIRE INSTALLATION OF THIS PRODUCT**

This products must be installed by a fully insured and licensed plumber only. Installation of any our product by anyone other than fully insured and licensed plumber shall void limited warranty. We recommends that such licensed plumber have experience in the installation of products.

Limited warranty is void on any commercial installation

We are not responsible for local code compliance for this product. Building and plumbing codes may vary from state-to-state in accordance to your location. We are not responsible for providing any compliance certifications.

Under no circumstances we are shall not be liable for any and all incidental damages sustained in connection with this product

Neither manufacture, nor distributor, nor retailer is responsible for water damage or flood caused due to use of this product.

Under no circumstances We shall not be liable for any and all fees, cost of installation/reinstallation/removal, subsequent damage or transportation in case of the product defect

Customer Service Phone: 562-229-0088. (Monday - Friday 9 AM - 5 PM Pacific Time)

Or Email: [help.woodbridge@gmail.com](mailto:help.woodbridge@gmail.com)

0920 REV. 4

## BEFORE YOU BEGIN

- Please read these instructions carefully to familiarize yourself with the required tools, materials, and installation sequences. Follow the sections that pertain to your particular installation. This will help you avoid costly mistakes. In addition to proper installation, read all operating and safety instructions.
- All information is based on the latest product information available at the time of publication. WOODBRIDGE® reserves the right to make changes in product characteristics, packaging, or availability at any time without notice.

## PRODUCT REQUIREMENTS

### A. Summary Of Key Requirements

Observe all local plumbing codes, Install the unit to a level subfloor, Provide properly -dimensioned framing.

### B. Product Inspection

Uncrate and inspect bath for damage. Leave all materials in the crate during construction to prevent damage.

## ROUGHING-IN

### Roughing-in:

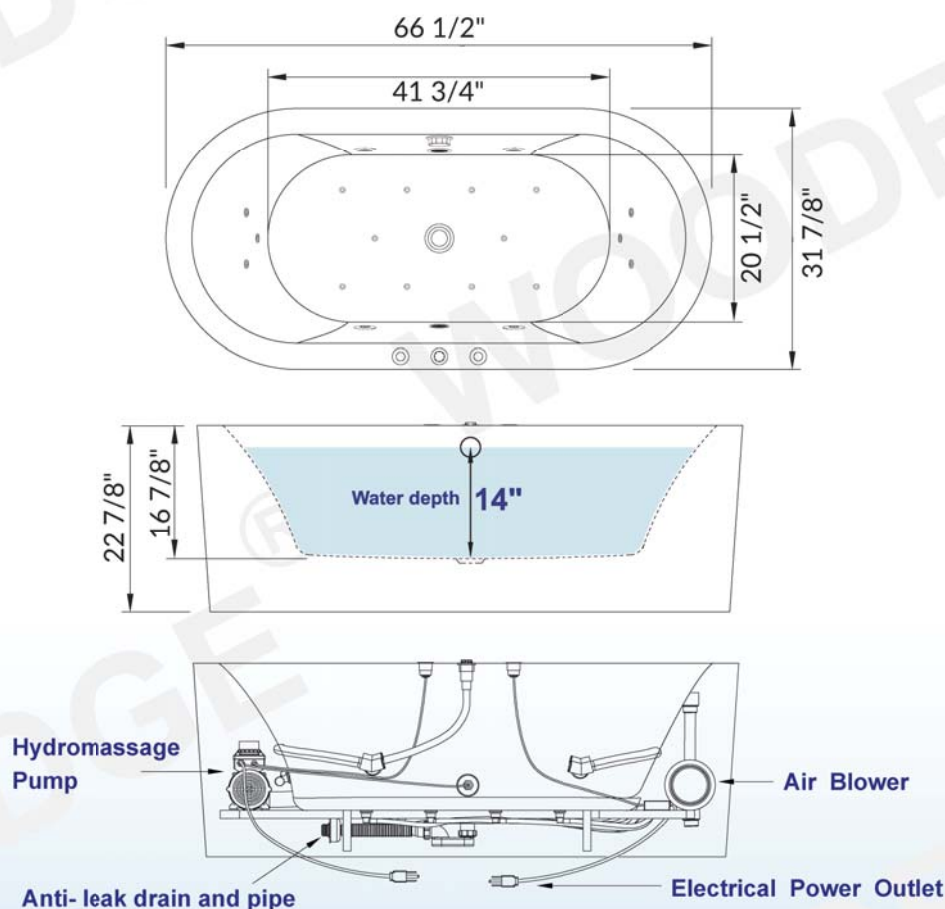

### IMPORTANT INFORMATION

- Measurements are  $\pm 1/2"$  and subject to change without notice
- Specifications & Configurations are subject to change without notice
- Pls measure tub on-site before installation
- Please note that installer(s) must be certify or warranty will be voided.
- Measurements herein supersede all others published prior to publication date shown below
- Before ordering or installing, please consider future access to equipment

## INSTALLATION REQUIREMENTS

### A. Tools Required

- Adjustable pipe
- wrench
- Rule
- Level
- Safety shoes
- Safety glasses
- Square
- Screwdriver
- Pliers
- Utility knife

### B. Materials Required:

- Plumbers putty
- Wall coverings, as necessary
- Silicone sealant
- Gypsum cement (optional)
- Construction adhesive (optional)
- Protective covering for bathtub
- Nails

### C. Clearance Requirements:

Check the rough-in and room dimensions to provide adequate space for the bath unit.

## SITE REQUIREMENTS

### A. Plumbing Preparation

Position the plumbing according to rough-in dimensions.

Cap the supplies and check for leaks.

## BEFORE INSTALLING UNIT

**CAUTION:** Ensure a watertight seal on the bath drain connections.

- A. Install the faucet valving and shower head tee. When drilling bathtub for faucet, ensure sufficient clearance. Open the hot and cold water valves and check the supply connections for leaks.
- B. Run water into the bath and check the drain connections for leaks.
- C. Fill the bathtub up to the overflow level and check overflow unit for leaks.

## INSTALL BATHTUB

**This products must be installed by a fully insured and licensed plumber only.**

- 1) Your new bathtub been manufactured to the highest possible standards, it has been factory tested and approved.
- 2) When removing bathtub from protective carton. **DO NOT LIFT BATHTUB BY PIPE WORK.** Inspect for any possible damage that may have occurred in transit. **IMPORTANT:** Bathtub must be installed level on all top edges.

- 3) Set the bathtub on two 4x4 pieces of lumber .so you can access from the bottom of the bathtub.
- 4) Connect Power Supply:  
Connect power supply to control unit. The electrical connections must comply with local authority regulations and must be done by an authorized electrician.
- 5) Fill bathtub with water to approximately 40 mm above the jets and trial run pump for 10-15 minutes. Check all the fittings for leaks and test the control functions. Switch off the spa pump and leave the unit filled with water (pump is not running) for at least another two minutes. Check the pump and pipes union connections for leaks. Hand tighten union connections if required.

**IMPORTANT:** Your bathtub has been factory tested and approved. It is the responsibility of the installer to test run the bathtub, check all the fittings for leaks and test the control functions. **NON OBSERVANCE WILL INVALIDATE FACTORY WARRANTY.**

- 6) The unit must be connected only to a supply circuit that is protected by a Ground-Fault Circuit Interrupter (GFCI). Such a GFCI should be provided by the installer and should be tested on a routine basis.

## WOODBIDGE<sup>®</sup> WHIRLPOOL & AIR BATHTUB



### ELECTRICAL REQUIREMENTS



#### AIR MASSAGE, WHIRLPOOL PUMP

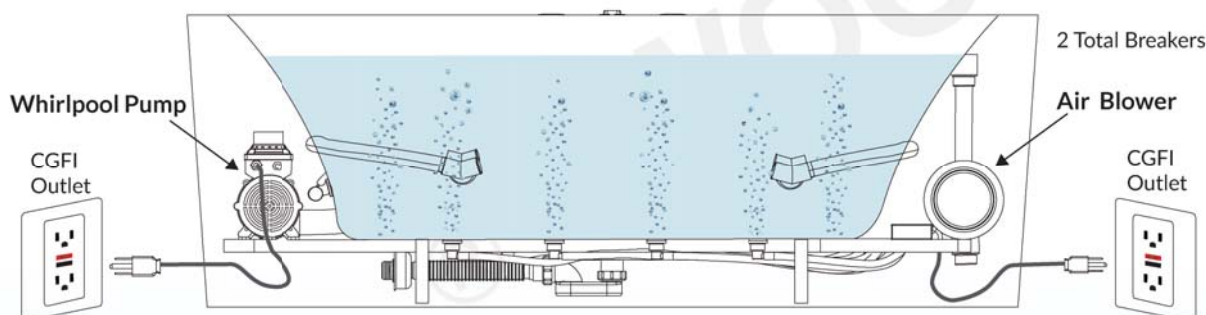

**120V 15AMP  
Dedicated  
GFCI Breaker**

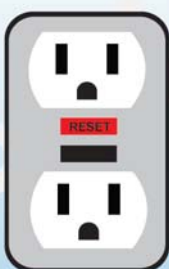

In the example above, there are 2 Dedicated 15AMP 110V GFCI Breakers.

1. One (1) Dedicated GFCI Breaker for the Whirlpool Pump
2. One (1) Dedicated GFCI Breaker for the Air Massage Blower

**Each Accessory Requires a Dedicated 120V 15AMP GFCI Breaker.**

**THESE CANNOT BE SHARED**

**(LED LIGHTS & OZONE CAN SHARE A BREAKER)**

## INSTALLATION - SITE PREPARATION

- Provide sufficient floor support. Check the floor at the installation site and make repairs as needed.
- Waterproof the floor is highly recommended. Finished floor must be level.
- Provide adequate clearance on all sides of the bathtub.
- Minimum of 2 inch waste drain pipe is required.

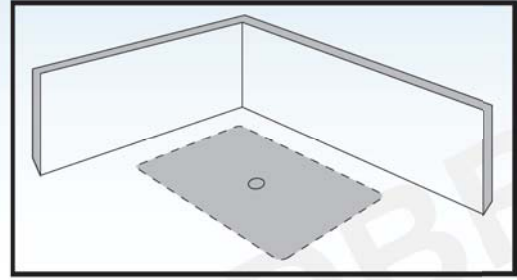

## WOODBIDGE BATHTUB INCLUDES HIGH QUALITY BATHTUB DRAIN & PIPE:

- Features:
- Anti -leakage Design and anti-odor Design.
  - Bug cover design to ground drain pipe
  - Tough & durable material , endure high temperature. Anti-aging, Anti-corrosion
  - No toxic, environmental, anti-crack in cold Weather

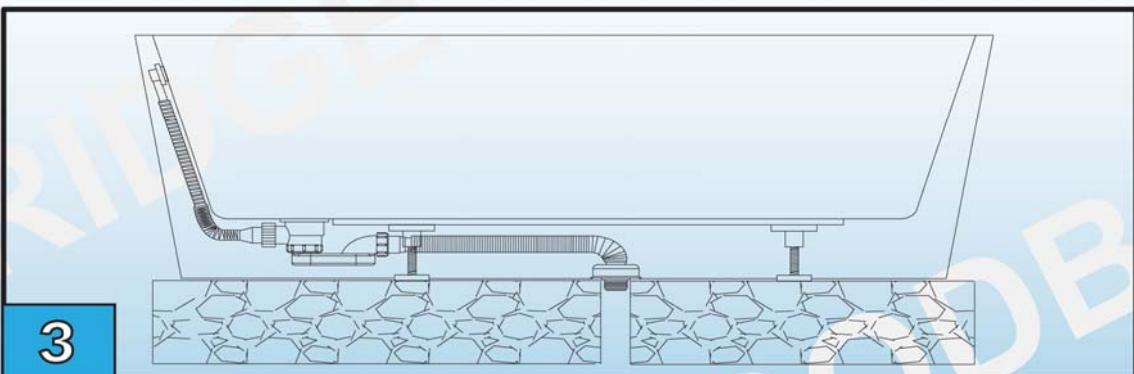
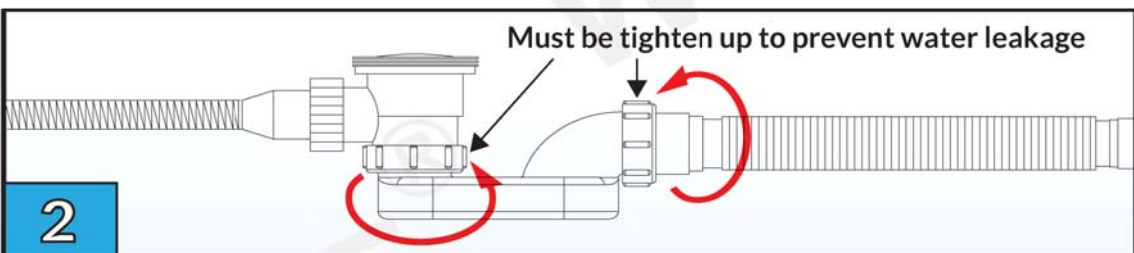
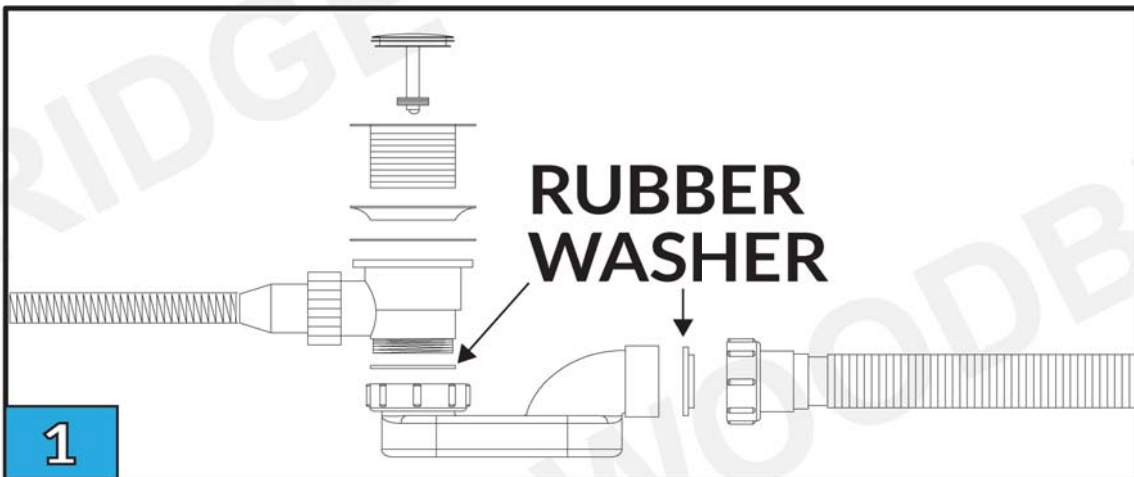
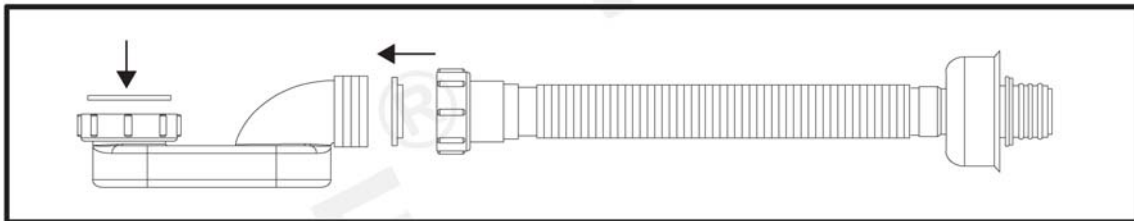

NOTES

BRIDGE® WOODBRIDGE®

---



---



---



---



---



---



---



---



---



---



---



---



---



---



---



---

INSTALLER INFORMATION

DATE OF INSTALL:

INSTALLER'S NAME:

PLUMBER:       CONTRACTOR:

LICENSE #:

## IMPORTANT SAFETY RULES

**ATTENTION!** ALWAYS FOLLOW THESE PRECAUTIONS WHEN USING A BATHTUB

- ⚠ Warning** The bathtub must be installed and used as described in this manual
- ⚠ Warning** Use caution when entering or exiting the bathtub
- ⚠ Warning** Do not permit children or persons with infirmities to use the bathtub without supervision of an adult
- ⚠ Warning** People using any medications or having adverse medical history must consult a physician prior to use of the bathtub to avoid potential hyperthermia and possible drowning
- ⚠ Warning** Water temperature over 100°F may cause hyperthermia and/or other health problems. Check water temperature and adjust it for your personal comfort
- ⚠ Warning** Never use bathtub while intoxicated, after taking meals or any alcoholic beverages. Consuming alcoholic beverages before or during bathing will cause drowsiness and may result in hyperthermia, loss of consciousness, or even drowning
- ⚠ Warning** If you are pregnant or you feel that you are may be pregnant, consult your doctor before using the bathtub
- ⚠ Warning** Never use any electrical devices such as hair dryer, lamp, telephone, tv, radio, or others within 5 feet of the bathtub
- ⚠ Warning** Do not overfill the bathtub before enetering. Entering the bathtub when filled will cause overflow and slippery conditions. Use extreme caution when entering and exiting

## Care and Cleaning

- Most dirt will wash off with mild soap and warm water.
- For tough spots, use liquid dish washing soap or non-chlorine bleach.
- Do not use abrasive material such steel wool or scouring pads to clean the acrylic surface.
- Always test the cleaning solution on a small area before using it on the entire surface.
- Do not allow cleaning to soak on the acrylic surface.
- Rinse thoroughly with water immediately and wipe dry with soft cloth.

## Repair and Maintenance

- Use liquid polish compound such as Gel-Gloss Kitchen and Bath Polish(TM) to keep the original shine of acrylic surface.
- Light scratches can be removed with polishing compound for automobiles.
- For deeper scratches use wet sandpaper (1500 grit or higher). Always add water when sanding and lightly sand the area larger than the scratch in a circular motion to remove the scratches. Repeat until the scratch is removed. Use soft cloth and small amount of polishing compound to restore shine. Repeat as needed until surface shine is restored.

### IMPORTANT!

**DO NOT USE:** Abrasive cleaners such as: acid, ammonia, bleach, and simmlar solutions. Use of such solutions may cause corrosion, finish peeling, and/or dull the surface.

**DO NOT USE:** Abrasive sponges or cloth. Never use steel, wool, or wired brushes that will permanently scratch the surface.

**Retain these installation instructions for future reference!**

Thank you for using WoodBridge products!

Please don't hesitate to contact us if you have any questions or concerns.

Customer Service Phone: 562-229-0088. (Monday - Friday 9 AM - 5 PM Pacific Time)

Or Email: [help.woodbridge@gmail.com](mailto:help.woodbridge@gmail.com)