

2-INCH W X 10-INCH D X 10-INCH H TRADITIONAL BRACKET

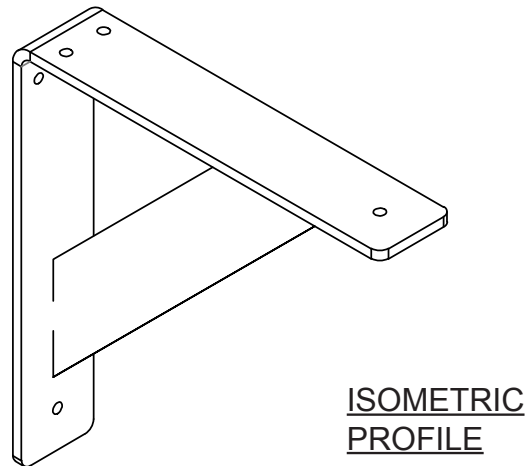
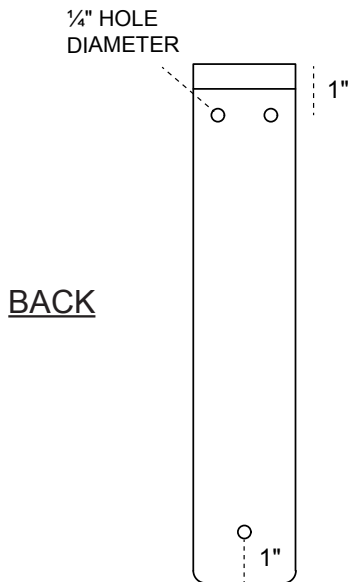
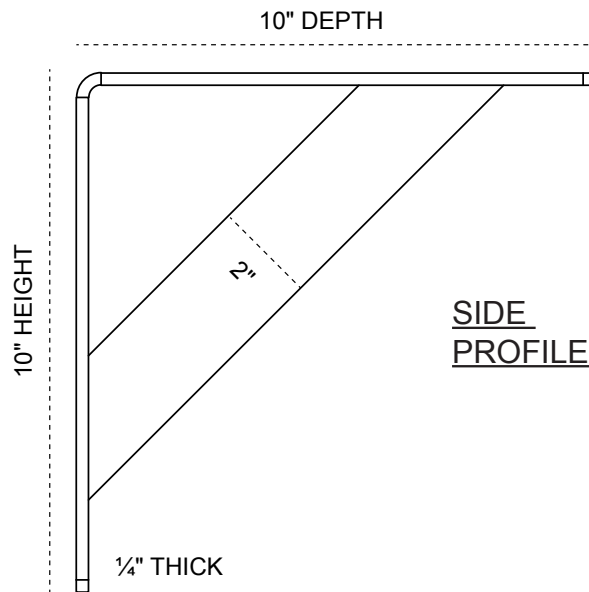
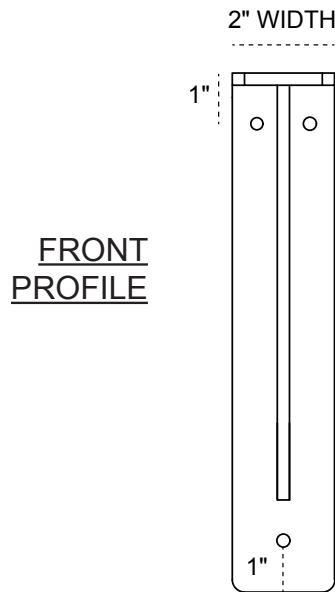

HEAVY-DUTY 1/4" THICK

AVAILABLE IN:
STAINLESS STEEL
ZINC PLATED STEEL
POWDER COATED BLACK

BKTM02X10X10TRSS
BKTM02X10X10TRCRS
BKTM02X10X10TRPBL

P:866.607.0453 | F: 866.591.3143
2300 W. Main St. | Clarksville, TX 75426
sales@ekenamillwork.com | www.ekenamillwork.com



EKENA
MILLWORK