



S5301

Bryce Series

Apron Kitchen Sink

Features

- Curved Apron Front
- 16 Gauge 304 Stainless Steel Construction
- Satin Brushed Finish
- Graduated Basin Ledge Allows You to Place Accessories Inside with Customizable Arrangement
- Non-Porous Corrosion-Resistant Surface
- Equipped with SoundShield™ Noise Deadening Pads (85% Bottom Basin Coverage)
- Protected with a Non-Toxic Anti-Condensation Coating
- Self-trimming design only requires a simple rough cut overlapping cabinet face for easy installation
- Limited Lifetime Warranty



Compatible Accessories

TG101 Stainless Steel Custom Fit Basin Rack
DT14 Drying Tray
CB7 Cutting Board
RSR1812 Stainless Steel Rolling Rack
SC1 Deluxe Sink Caddy
TBASK Stainless Steel Basket Strainer
MF1 FuFu Microfiber Sink Loofah
T5301 Sink Cut-Out Template
Installation Instructions

Codes/Standards

ASME A112.19.3/CSA B45.4

1-(503) 455-8336

Sink specifications may change without notice. Please visit www.ticorsinks.com for the most current information. Updated 03/21/2018



S5301

Bryce Series

Apron Kitchen Sink

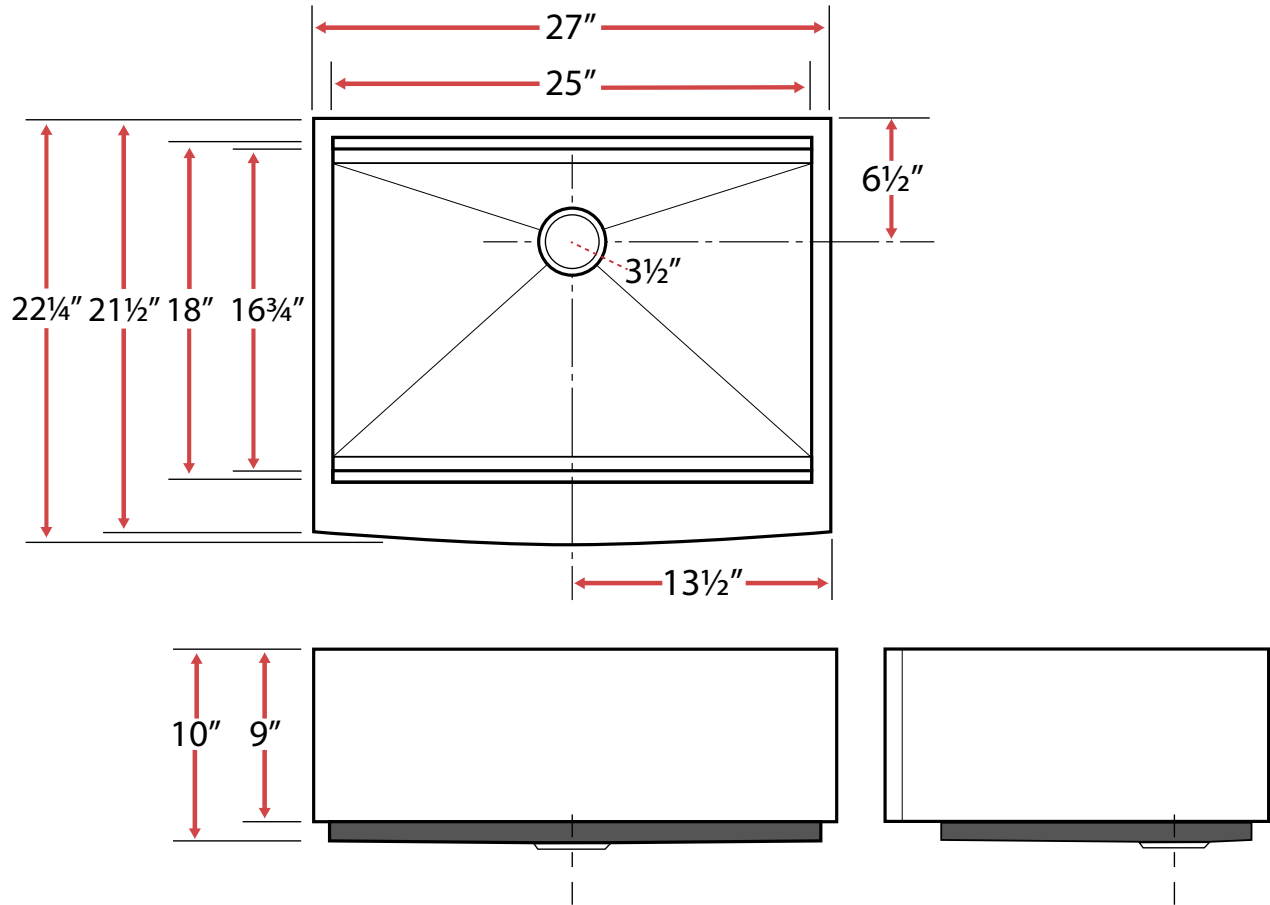

Technical Information

- Sink Collection: **Bryce Series**
- Sink Model Number: **S5301**
- Corner Style: **Zero Radius**
- Sink Length (inches): **27**
- Sink Width (inches): **22 1/4**
- Sink Basin Depth (inches): **10**
- Sink Apron (inches): **9**
- Drain Opening (inches): **3.5**
- Drain Position: **Rear**
- Bowl Configuration: **Single**
- Installation Type: **Undermount/Flush-Mount**
- Minimum Sink Base Cabinet Width Required: **27"**

(Cabinet May Require Additional Modifications at Minimum Size. Consult an Installer for Confirmation)

1-(503) 455-8336

Sink specifications may change without notice. Please visit www.ticorsinks.com for the most current information. Updated 03/21/2018