

# MADISON PARK® ASSEMBLY INSTRUCTIONS

**Description:** Drawer Chest



**Important safety instructions:**

- Please read carefully all instructions before assembly.
- For your safety and ease, assembly by two or more adults is recommended.
- Keep instructions for future use.

**Pre-assembly:**

- Do not discard any content until assembly is complete to avoid accidentally discarding small parts or hardware.
- Take out all parts and hardware from box.

**Parts List**

Item	Description	QTY
P1	Chest 	1
P2	Feet 	4

**Hardware List**

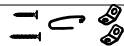
Item	Description	QTY
H1	Anti Tip Kit 	1 SET



**DISCLAIMER:**

**WHEN PROPERLY ASSEMBLED, THIS ITEM IS SAFE FOR INTENDED USE. SELLER IS NOT LIABLE FOR ANY DAMAGES RESULTING FROM ITEM BEING IMPROPERLY ASSEMBLED AFTER PURCHASE.**

**Assembly Procedures:**

- Step 1. Assemble the chest on a flat, soft surface such as a carpet or cloth to prevent scratching the finish.
- 1) Attach each foot (P2) to the bottom of chest (P1) as shown below, securely tighten all feet, but do not over tighten.
  - 2) Turn the assembled chest to an upright position.
  - 4) Assembly is complete. **Failure to follow these instructions may cause the bolts to misalign during assembly.**
  - 5) **Recommend that you attach the products to a wall as a safety precaution.** Please see the other instructions "Furniture Safety Bracket Tip Resistant".

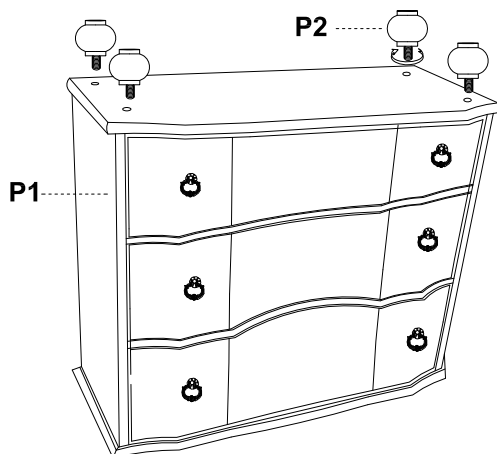

**ADDITIONAL NOTE ABOUT SAFETY:**

**BOLTS MAY LOOSEN DURING NORMAL EVERYDAY USE. THEY SHOULD BE INSPECTED AT LEAST EVERY 3 MONTHS AND RE-TIGHTENED AS NEEDED TO PREVENT DAMAGE OR INJURY, AND ENSURE STABILITY.**

Thank you for you purchase

# Furniture Safety Bracket Tip Resistant

- Designed to help prevent furniture tipover.
- Detachable strap allows for easy moving of furniture for cleaning.
- Also helps prevent furniture from tipping during minor tremors.

## Installation:

### Short Screw (1pc)



### Long Screw (1pc)



### Strap (1pc)



### Bracket (2pcs)

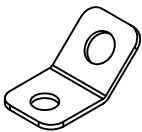

1. Locate a wall stud behind your furniture. Position a bracket on the stud approximately 1" below the top frame of the furniture. Mark and drill pilot hole into the center of the stud with a 3/32" drill bit. Attach a bracket to the stud with the long screws provided.

2. On the back of the furniture, a bracket will need to be attached to the furniture frame at the top. To do this, temporarily move the furniture into its final position and mark the location of the wall bracket on the furniture frame. Move the furniture away from the wall and place a bracket on the mark. Mark and drill holes for screws with a 3/32" drill bit. Attach the bracket to the furniture with the short screws provided.

3. Move the furniture into its final position, taking care to line up the wall bracket with the furniture bracket. Thread a strap through the bracket as shown in the illustration. Tighten strap until snug. Do not overtighten.

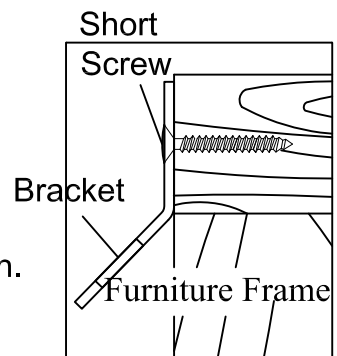
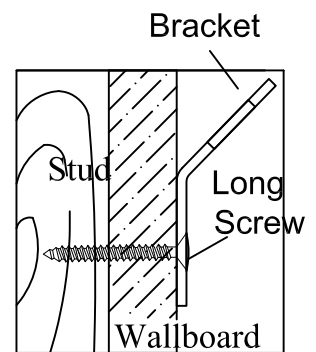

## Important:

Check to be sure the wall bracket is firmly screwed into wall stud, the furniture bracket is firmly attached to the frame, and the strap is snug.

## Caution:

This product is not to be a substitute for proper parental supervision. Manufacturer assumes no liability for improper installation or excessive loads placed on screws brackets or straps.

## Warning:

Children have died from furniture tipover. To reduce the risk of furniture tipover:

- ALWAYS install tipover restraint provided.
- NEVER put a TV on this product.
- NEVER allow children to stand, climb or hang on drawers, doors, or shelves.
- NEVER open more than one drawer at a time.
- Place heaviest items in the lowest drawers.

This is a permanent label.

Do not remove!

