



René

R3-1007-CARBON

Low Divide Double Bowl Sink

Flange UPC: 841412141086

Standard Strainer UPC: 841412141093

FEATURES

- Undermount Installation
- 33" Minimum Cabinet Size
- 80% Quartz 20% Acrylic
- Heat Resistant up to 550°
- Anti-bacterial Surface
- Stain Resistant
- Scratch Resistant
- Multiple Colors Available
- Cutout Template
- Installation Hardware Included
- cUPC Certified
- Limited Lifetime Warranty

ACCESSORIES



GRANITE QUARTZ

Our granite quartz sinks are made with 80% Quartz and 20% Acrylic, with a non-porous finish that prevents the growth of bacteria. They are extremely scratch resistant, can withstand temperatures up to 550 Degrees, and are unaffected by household acids and cleaners. They are also completely stain resistant.

DIMENSIONS

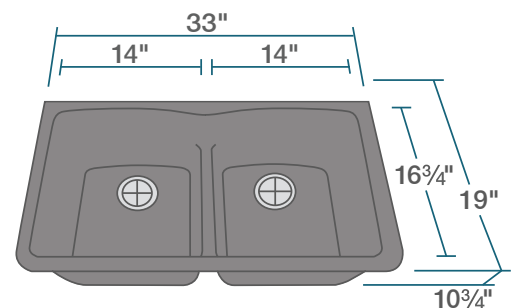

www.renesinks.com
872.241.0016
sales@renesinks.com