









Important safety instructions:

- Please read carefully all instructions before assembly.
- For your safety and ease, assembly by two or more adults is recommended.
- Keep instructions for future use.

Pre-assembly:





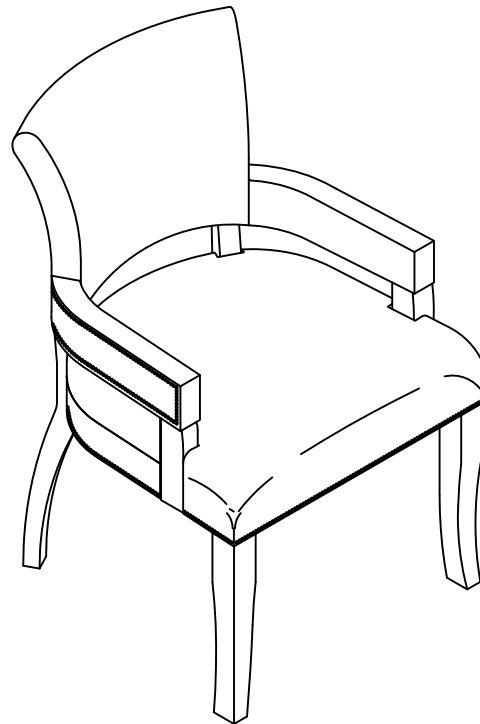

- Do not discard any content until assembly is complete to avoid accidentally discarding small parts or hardware.
- Take out all parts and hardware from box.

Parts List

Item	Description		QTY
P1	Chair Back Top		1
P2	Seat Cushion		1
P3	Right Arm Post	 	1
P4	Left Arm Post	 	1
P5	Front Legs		2
P6	Back Legs		2



Hardware List

Item	Description		QTY
H1	Long Bolts Ø5/16**2-3/4"L		4
H2	Medium Bolts Ø5/16**2"L		4
H3	Short Bolts Ø5/16**1-3/4" L		4
H4	Short Bolts Ø5/16**3/4"L		6
H5	Lock Washers 5/16"		18
H6	Flat Washers 5/16"		18
H7	Allen Wrench 5/16"		1

DISCLAIMER:



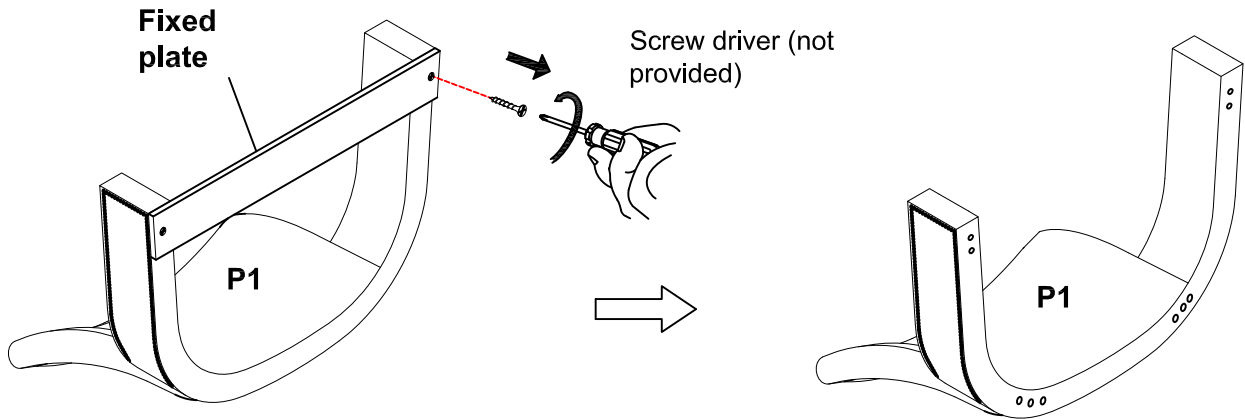

WHEN PROPERLY ASSEMBLED, THIS ITEM IS SAFE FOR INTENDED USE. SELLER IS NOT LIABLE FOR ANY DAMAGES RESULTING FROM ITEM BEING IMPROPERLY ASSEMBLED AFTER PURCHASE.

Assembly Procedures:

Step 1. Assemble the chair on a flat, soft surface such as a carpet or cloth to prevent scratching the finish. Remove the fixed plate from the bottom of chair back top (P1) by unscrewing out of the screws with screw driver(not provided).





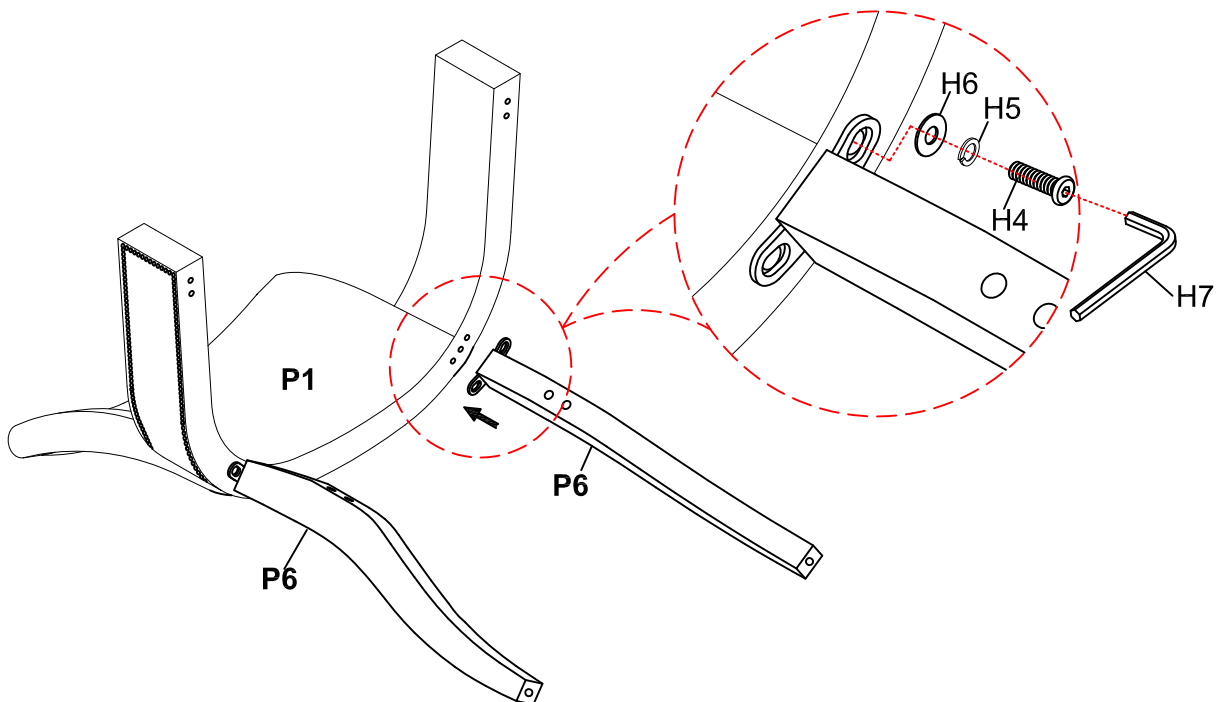

Step 2. Attach the each back leg (P6) to chair back top (P1) as shown below.

- (H4)x4 Short Bolts $\varnothing 5/16'' \times 3/4'' L$ 
- (H5)x4 Lock Washers 5/16" 
- (H6)x4 Flat Washers 5/16" 
- (H7)x1 Allen Wrench 5/16" 





Step 3. Loosely attach right arm post (P3) and left arm post (P4) to seat cushion (P2) according to the labels "P3", "P4" on the arm post as shown below.

- (H3)x4 Short Bolts $\varnothing 5/16'' \times 1-3/4''$ 
- (H5)x4 Lock Washers 5/16" 
- (H6)x4 Flat Washers 5/16" 
- (H7)x1 Allen Wrench 5/16" 

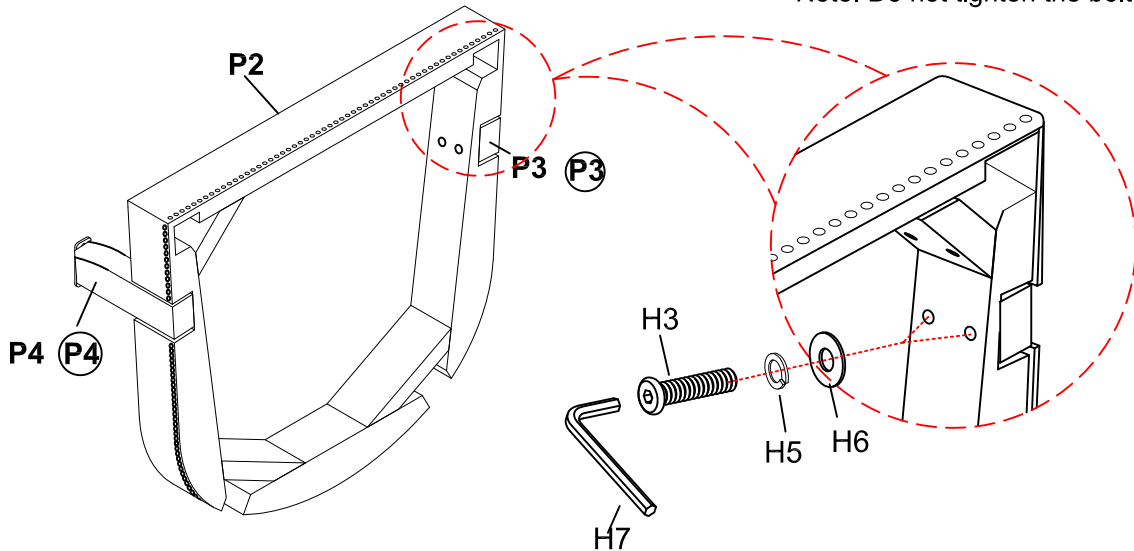
Note: Do not tighten the bolts.





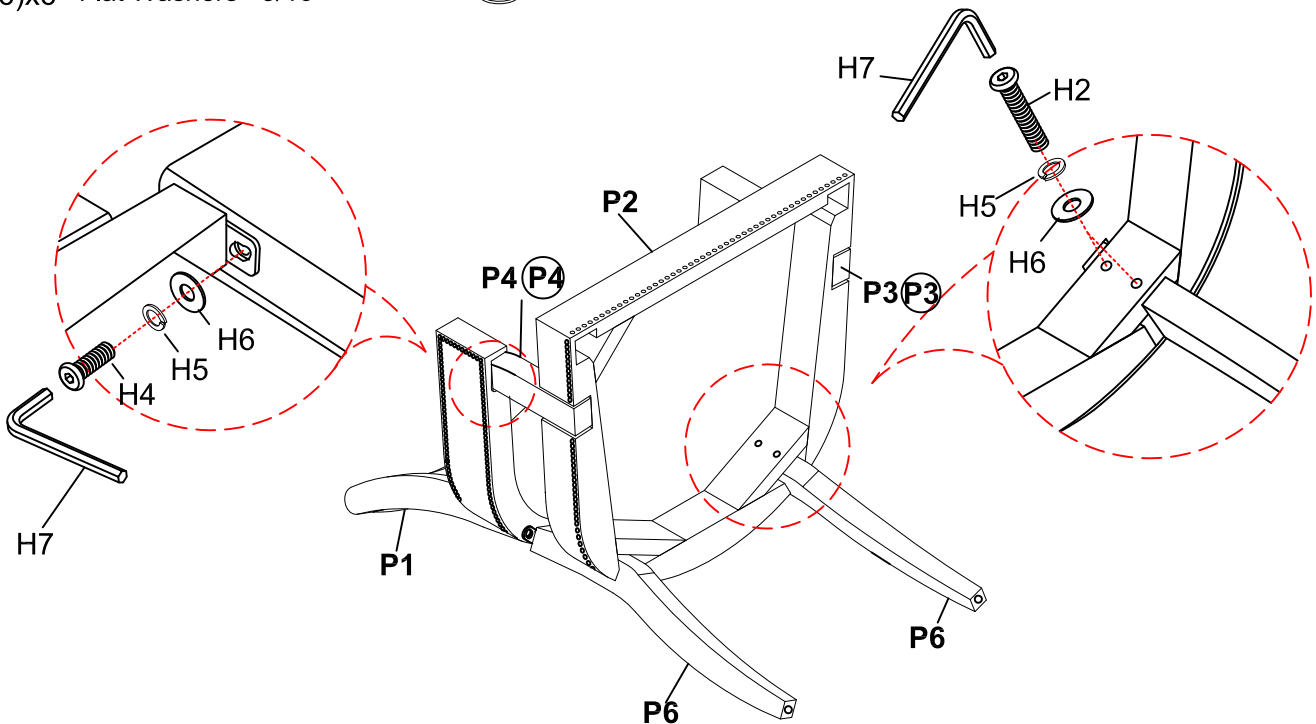

Step 4. Attach the assembled arm posts (P3, P4) and seat cushion (P2) to the bottom of chair back top (P1) and back legs (P6) as shown below.

- (H2)x4 Medium Bolts $\varnothing 5/16'' \times 2''$ 
- (H5)x6 Lock Washers 5/16" 
- (H6)x6 Flat Washers 5/16" 
- (H4)x2 Short Bolts $\varnothing 5/16'' \times 3/4''$ 
- (H7)x1 Allen Wrench 5/16" 



Step 5. Attach the front legs (P5) to the seat cushion (P2) as shown below.

- (H1)x4 Long Bolts $\varnothing 5/16'' \times 2-3/4''$ L 
- (H5)x4 Lock Washers 5/16" 
- (H6)x4 Flat Washers 5/16" 
- (H7)x1 Allen Wrench 5/16" 

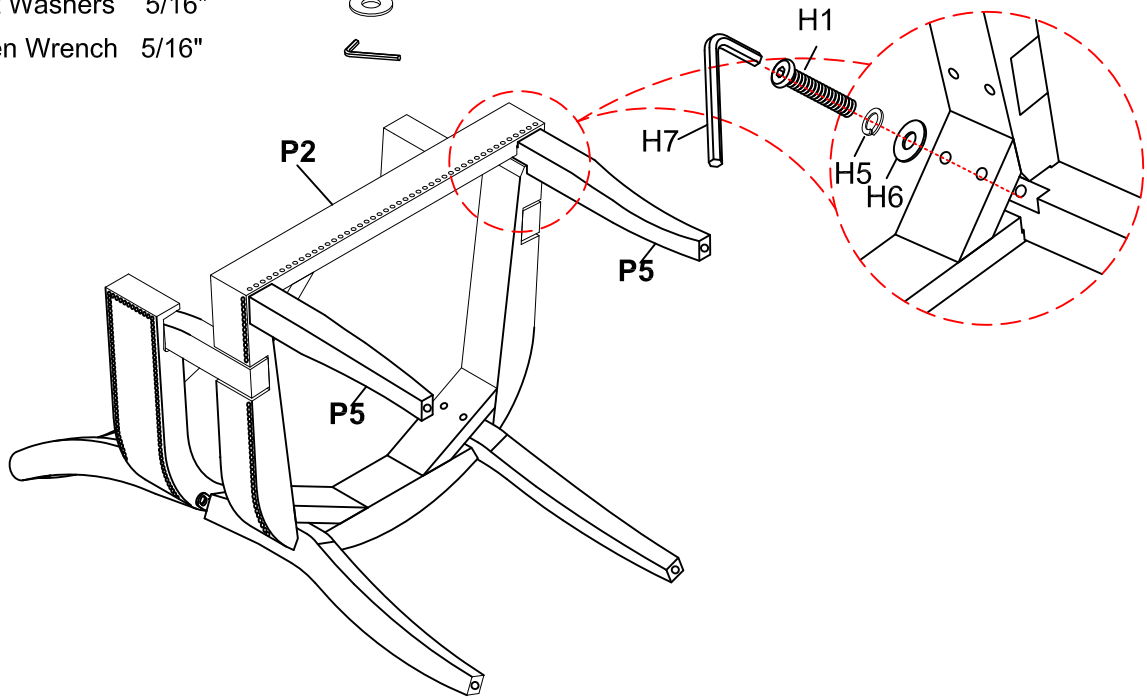

Step 6.

- 1) Turn the assembled chair to an upright position. Make sure the chair is level and securely tighten all bolts by Allen wrench (H7).
- 2) **Leveler adjustment:** Levelers are pre-installed on the legs and adjust as needed to make sure the chair is leveled.
- 3) Assembly is complete. **Failure to follow these instructions may cause the bolts to misalign during assembly.**

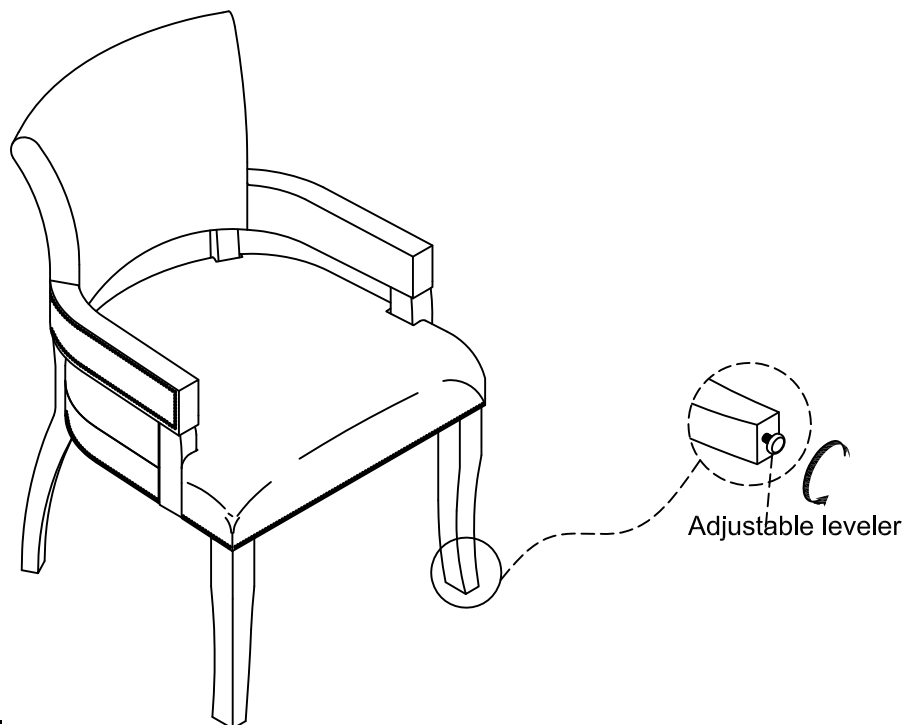

ADDITIONAL NOTE ABOUT SAFETY:

BOLTS MAY LOOSEN DURING NORMAL EVERYDAY USE.

THEY SHOULD BE INSPECTED AT LEAST EVERY 3 MONTHS AND RE-TIGHTENED AS NEEDED TO PREVENT DAMAGE OR INJURY, AND ENSURE STABILITY.

Thank you for your purchase