

CARE AND MAINTENANCE

Store outdoor furniture indoors or cover well when not in use.

Remove wooden furniture from standing water. Dust regularly with small brush or vacuum







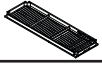

Spills should be taken care of immediately before they harden or stain with a slightly dampened sponge.

NOTICE

- * Please make sure that you have all parts indicated before you begin assembly of this item
- * This item should be assembled on a soft surface to prevent scratching the finish during assembly
- * This item may require periodic tightening

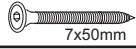
 **SAFAVIEH**
O U T D O O R

Part List and Hardware List

PIECE	DESCRIPTION	PICTURE	QUANTITY
A	Sunlouger Frame		1X
B	Frone leg		2X
C	Back leg		2X
D	Cross bar of leg		2X
E	Screw -1	 7x50mm	4X
H1	Allen bolt L	 8x50mm	8X
H2	Washer		8X
H3	Allen key		2X

Model# PAT7024

Product Dimensions:24.8" W x 80.9" D x 37.4" H

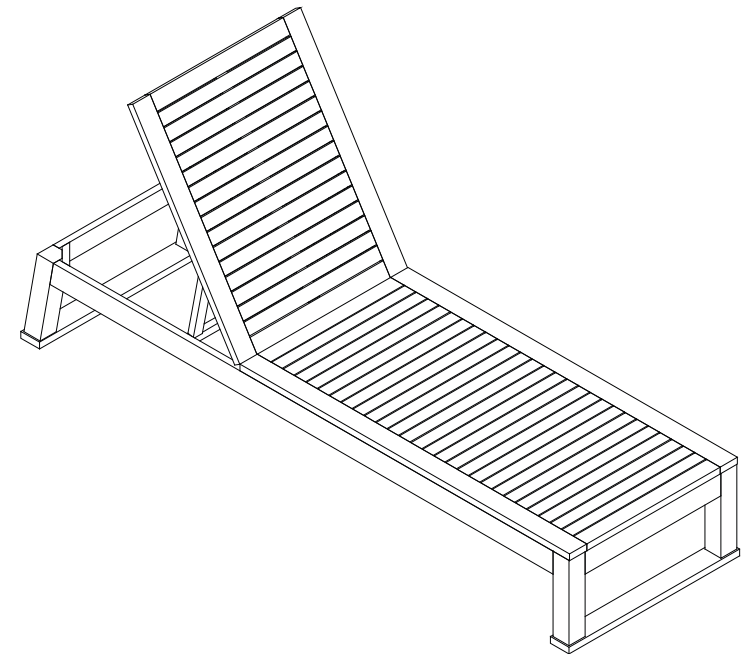

PREPARATION

Before beginning assembly of product, make sure all parts are present. Compare parts with package contents list and hardware contents list. If any part is missing or damaged, do not attempt to assemble the product.

Estimated Assembly Time: 30 minutes.

Tools Required for Assembly (included): Allen Key

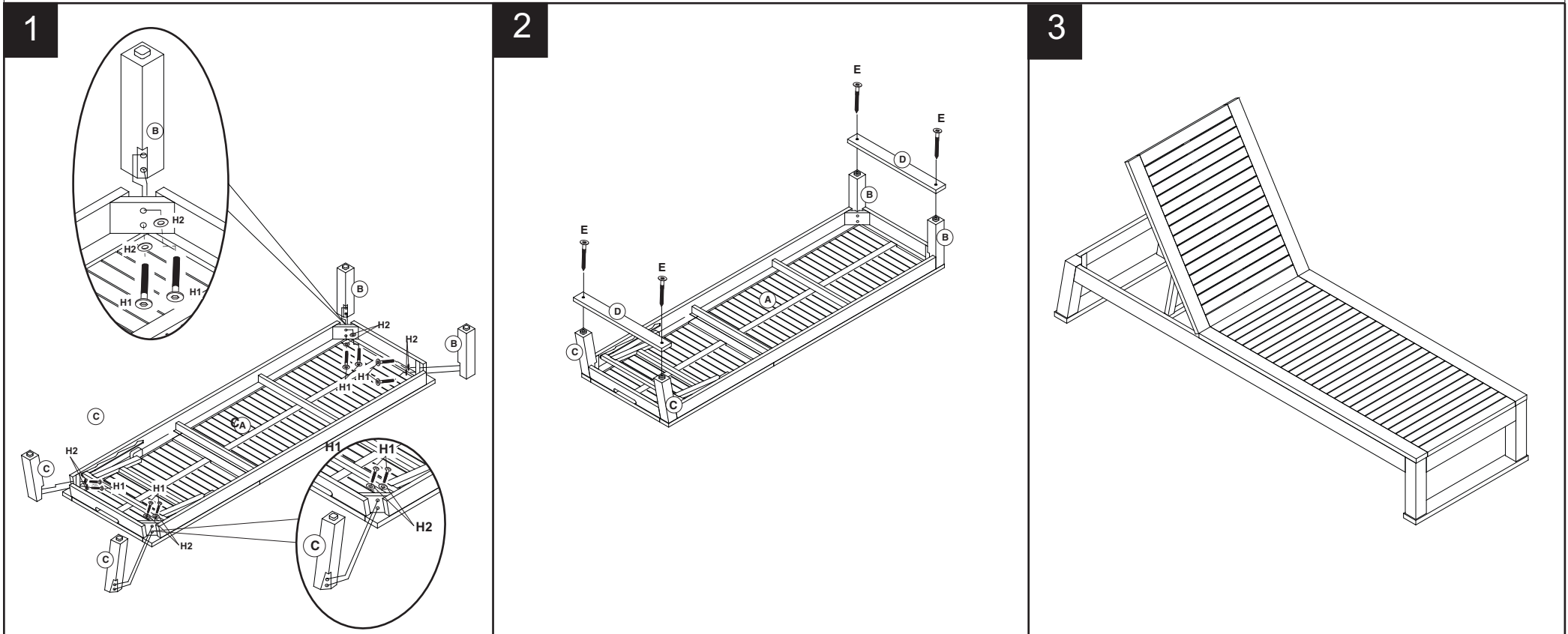

Step 1

Attached (B) to (A), insert (H2)
inside, using (H1) tighten by (H3)

Step 2

Attached (D) to (B), using (E) tighten by (H3)