

Features

- Left-hand trip lever.
- Solid-brass construction for durability.
- KOHLER finishes resist corrosion and tarnish.
- For use with Cimarron Comfort Height toilets.



ADA

Codes/Standards















ADA
ICC/ANSI A117.1

KOHLER® One-Year Limited Warranty

See website for detailed warranty information.

Available Colors/Finishes

Color tiles intended for reference only.

Color	Code	Description
	SN	Vibrant® Polished Nickel
	AF	Vibrant® French Gold
	PB	Vibrant® Polished Brass
	BGD	Vibrant® Moderne Brushed Gold
	G	Brushed Chrome
	BN	Vibrant® Brushed Nickel
	BV	Vibrant® Brushed Bronze
	BRZ	Oil-Rubbed Bronze
	2BZ	Oil-Rubbed Bronze
	BL	Matte Black
	2MB	Vibrant Brushed Moderne Brass
	RGD	Vibrant Rose Gold
	TT	Titanium
	VNT	Vintage Nickel

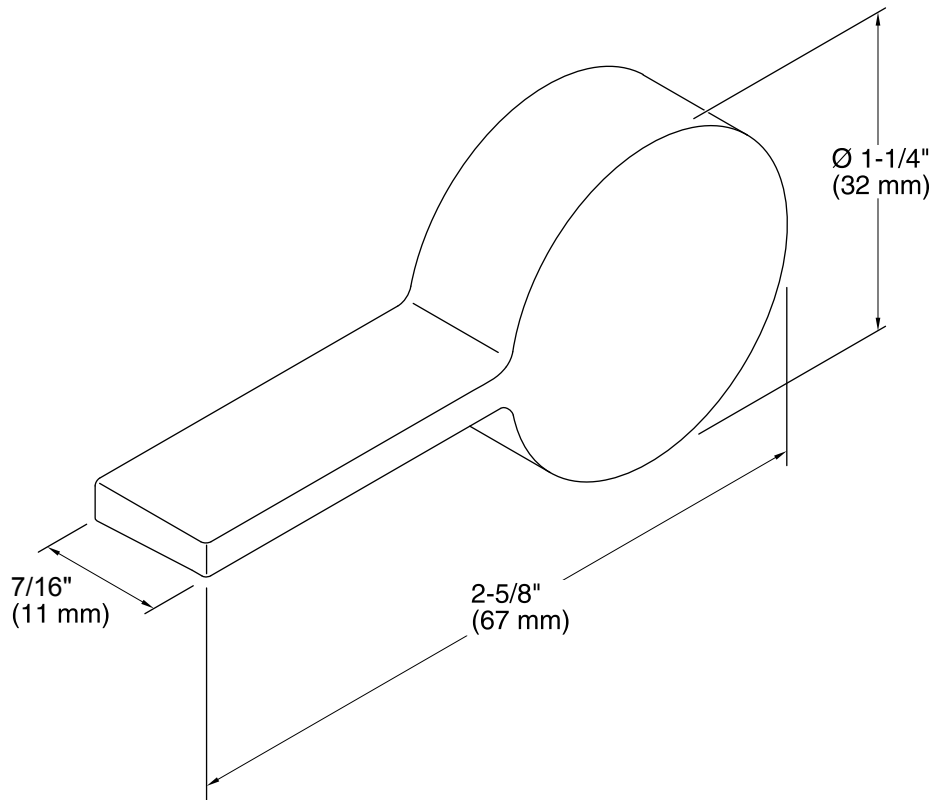

Technical Information

All product dimensions are nominal.

Notes

ADA compliant when installed to the specific requirements of these regulations.