

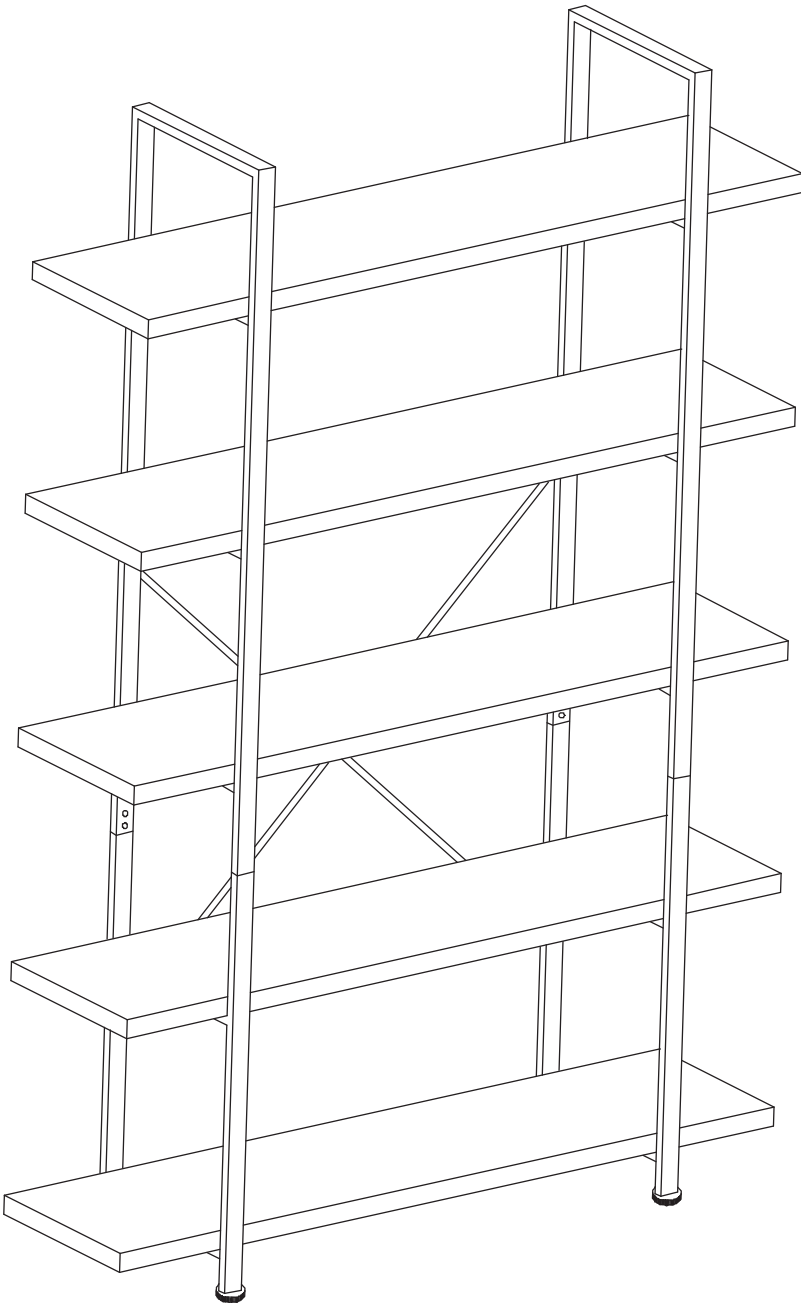















INDUSTRIAL STYLE 5-TIER BOOKSHELF

Read all assembly and care instructions carefully before using this product. Save this document for future reference.
Assemble components on a soft, clean surface to avoid scratching or damaging the finish.



Inspect packaging to ensure all parts are accounted for before disposing of packing materials.

No.	PARTS		QTY.
A		Shelf	5
B		Top Side Panel	2
C		Bottom Side Panel	2
D		Support Bar	2
E		M6 x 12mm Bolt	12
F		M6 x 15mm Bolt	1
G		M6 x 25mm Bolt	20
H		Nut	1
I		Foot	4
J		Wall Anchor	4
K		M4 x 40mm Screw	4
L		Bracket	2
M		Zip Tie	2
N		Spanner	1
O		Hex Key	1

TOOLS REQUIRED (not included)

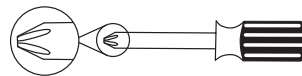

Phillips Screwdriver

! WARNING !

CHOKING HAZARD — This item contains small parts that can be swallowed by children. Keep children away during assembly.

! HELPFUL HINT

Do not fully tighten fittings until all components are assembled. If fittings are tightened too soon, mounting holes may not align, and parts may not easily fit together.

ASSEMBLY

Read carefully and understand assembly before beginning.
Do not fully tighten fittings until all components have been assembled.

STEP 1

B: 2
C: 2
E: 8

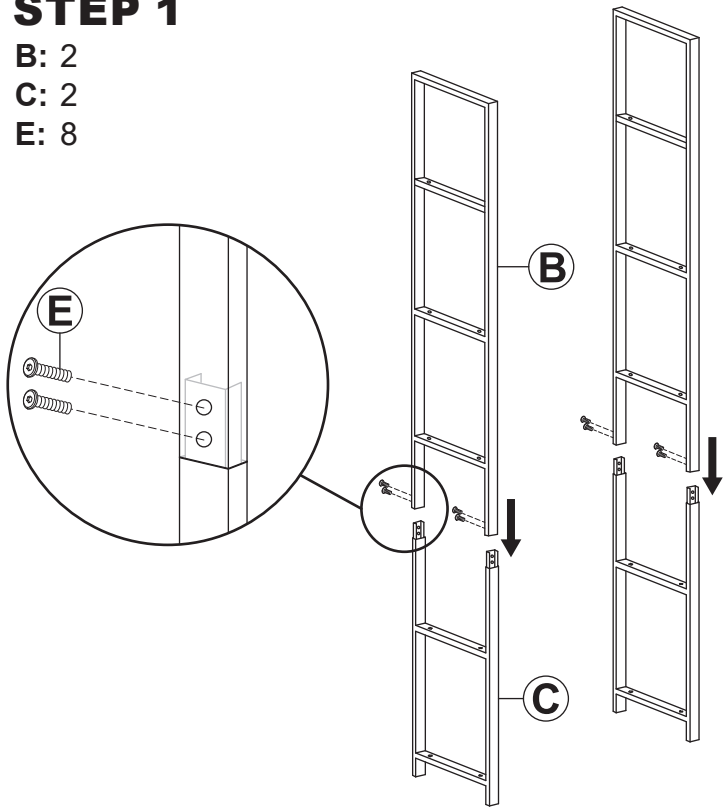

STEP 2

D: 2
E: 4
F: 1
H: 1
I: 4

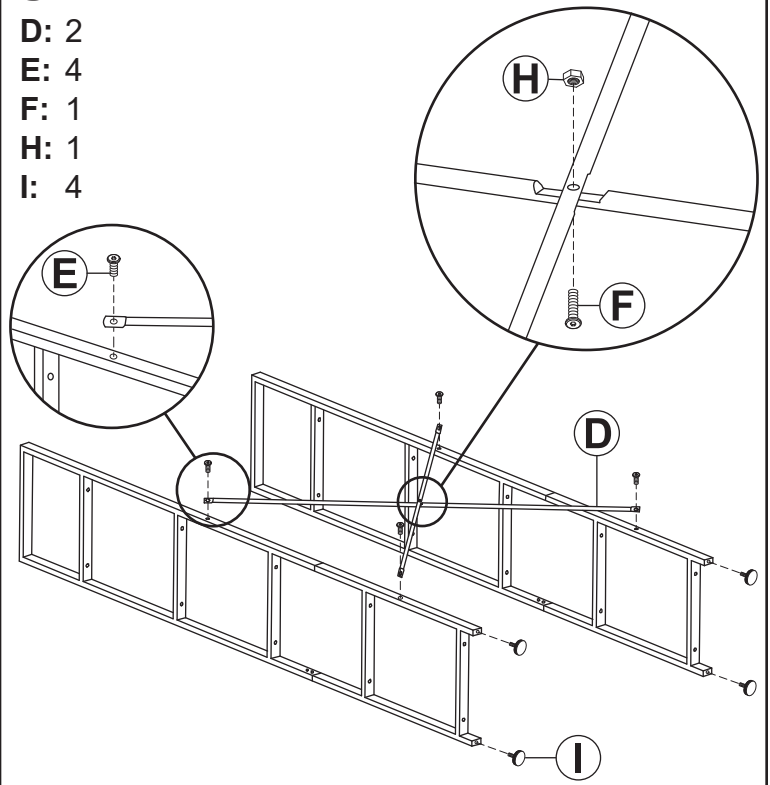

STEP 3

A: 5
G: 20

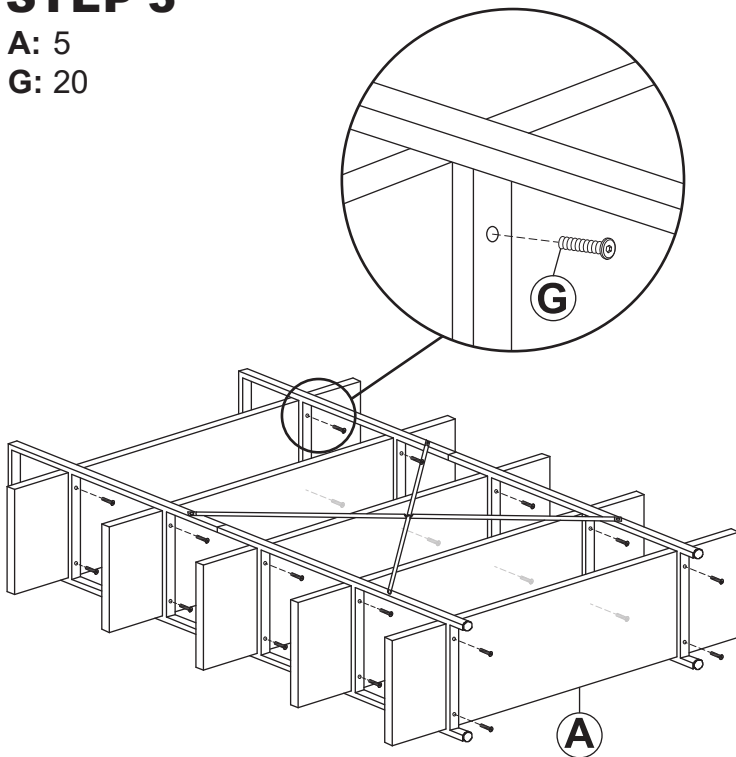

Tighten all fittings; do not over-tighten.

STEP 4

J: 4
K: 4
L: 2
M: 2

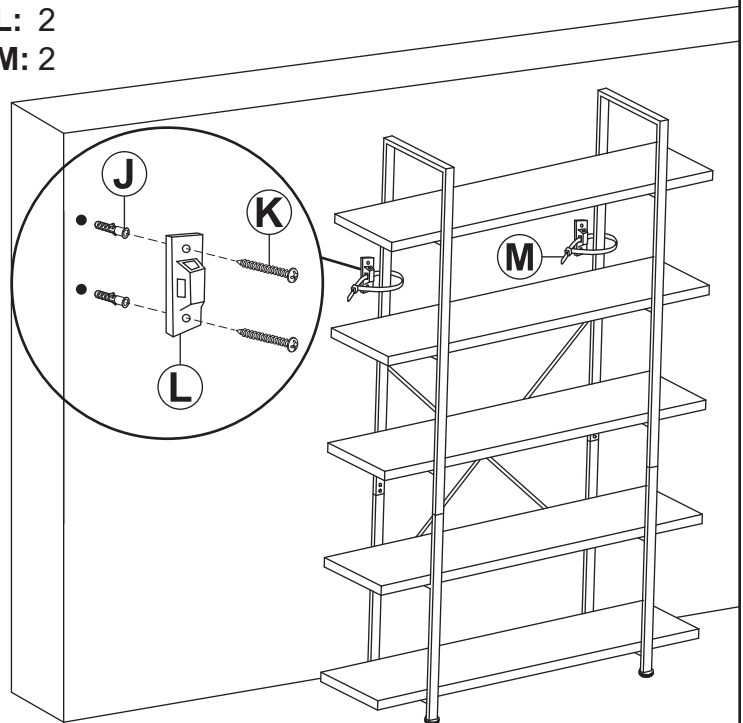

Care & Maintenance



To clean the shelving, a feather duster or a dry, soft cloth is recommended.



Remove stains with a slightly damp cloth and mild soap. Dry with a soft cloth to prevent water damage.



Do not clean shelving with harsh cleansers or polish.



Do not put hot items or any liquids directly on the furniture surface.



Do not climb or sit on the shelving unit as it may tip over and cause serious injury.

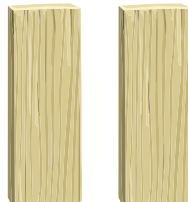

This shelving system is meant for drywall/stud mounting. If walls are concrete, brick or plaster, consult a professional.

! SAFETY STATEMENTS & WARNINGS !

- Residential use only. Not for commercial or industrial use.
- Indoor use only. Do not use outdoors.
- Ensure fittings are tight before use. Periodically check fitting to ensure they are tight.
- Only use this shelving unit on a flat, level surface.
- Do not climb on or sit on the shelves.
- Supervise children; never allow children to climb or sit on this unit as it may tip over and cause serious injury.
- Do not place liquids or hot items on the shelves.
- Never use chemical cleaning products or polishes as they may damage the finish.
- Do not overload the shelves as doing so may cause the shelves to sag.
- Always place the heaviest items on the bottom shelf. Uneven weight distribution may cause the stand to tip over.
- Do not place the unit in direct sunlight.
- Do not place near heating or cooling vents.
- Do not write on furniture without a padded barrier to protect the surface.

Any modification to the product or failure to follow recommended care will void the product warranty.

! NOTICE:

Manufacturer and seller expressly disclaim any and all liability from personal injury, property damage or loss, whether direct or indirect, or incidental, resulting from the incorrect attachment, improper use, inadequate maintenance, or neglect of this product.