



MANCHESTER

FVN2372-D

INSTALLATION GUIDE

CONTENTS:

Mirror.....	PAGE 2
Cabinet.....	PAGE 3
Sink.....	PAGE 3

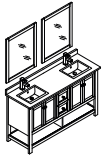

FVN2372-D MANCHESTER INSTALLATION GUIDE



FVN2372-D
Vanity Front

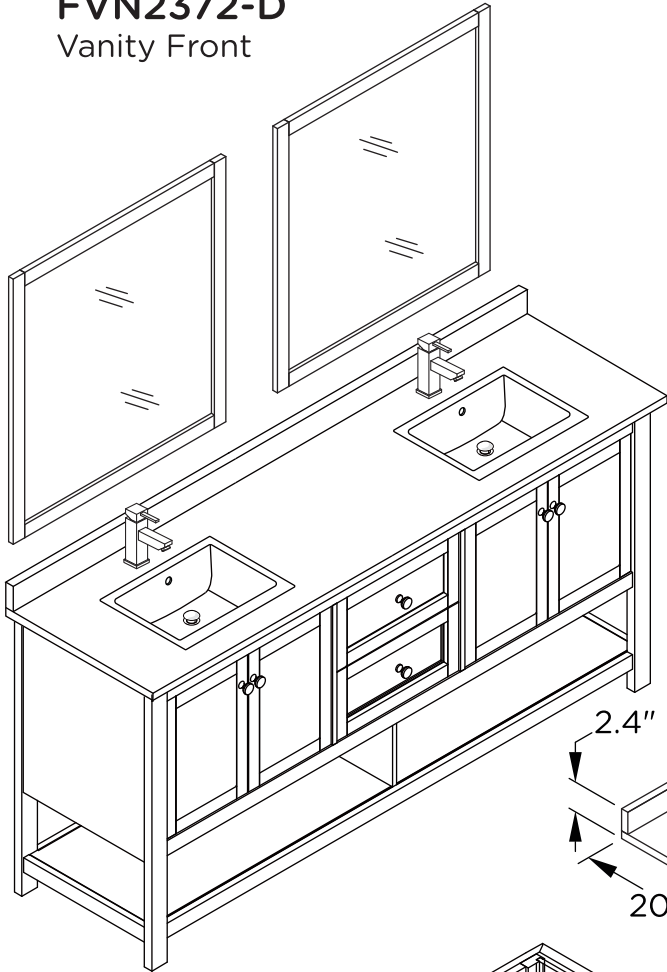

FMR2303
Mirror Front

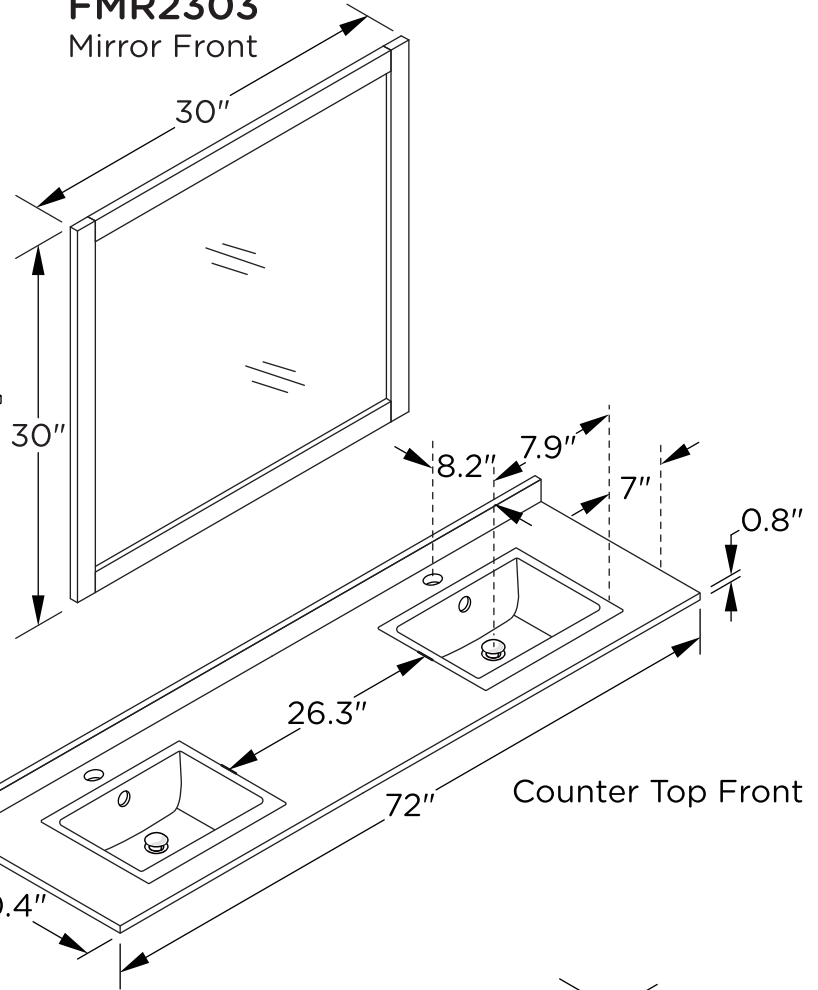

Counter Top Front

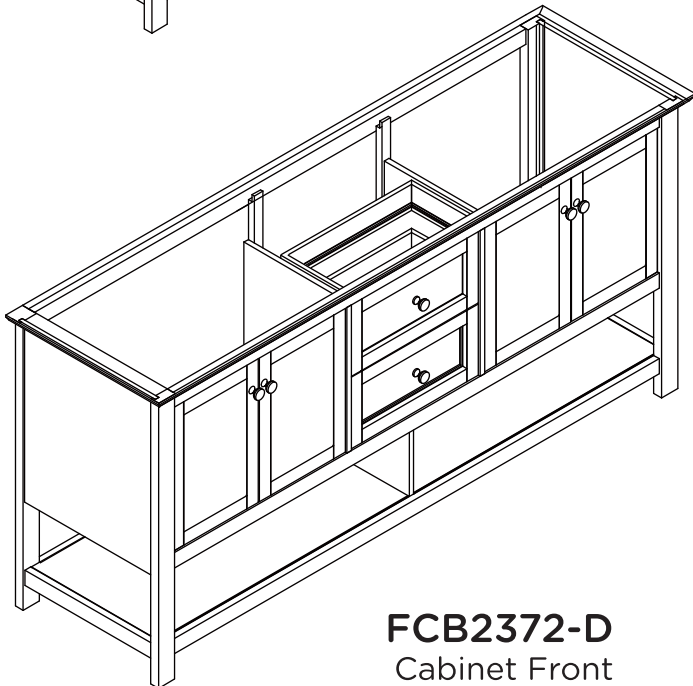

FCB2372-D
Cabinet Front

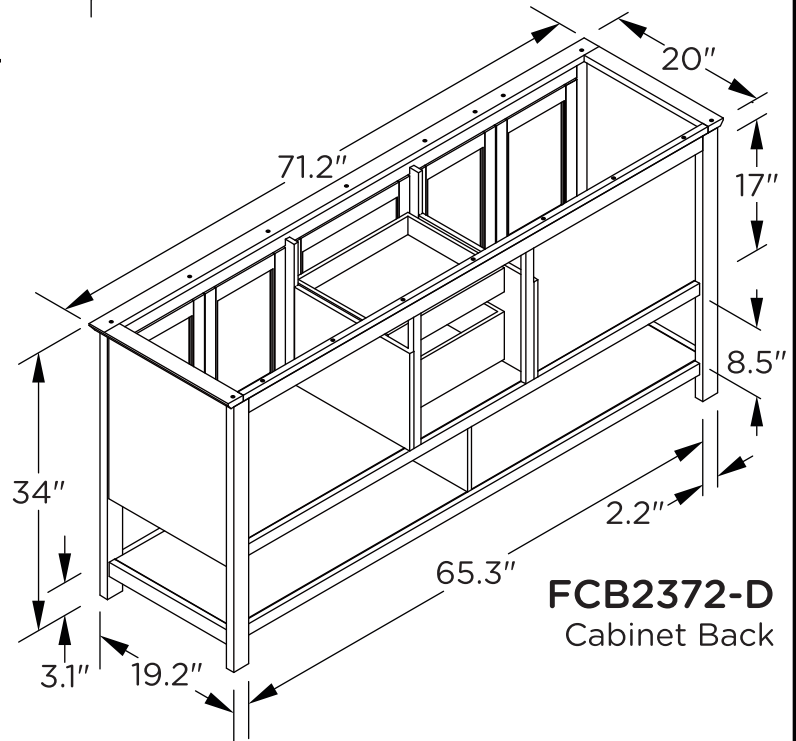

FCB2372-D
Cabinet Back

>All dimensions & specifications are approximate and subject to change without notice.



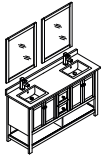

FVN2372-D MANCHESTER INSTALLATION GUIDE



TOOLS REQUIRED FOR ASSEMBLY

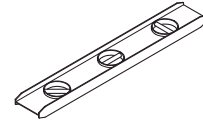
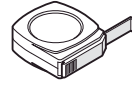
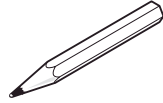
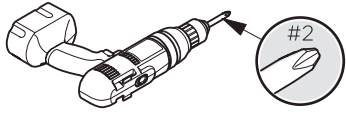

MIRROR INSTALLATION

- 1** Measure distance between the brackets on the back of a mirror and mark it on the wall using a level. Once marked, drill the holes in the wall.

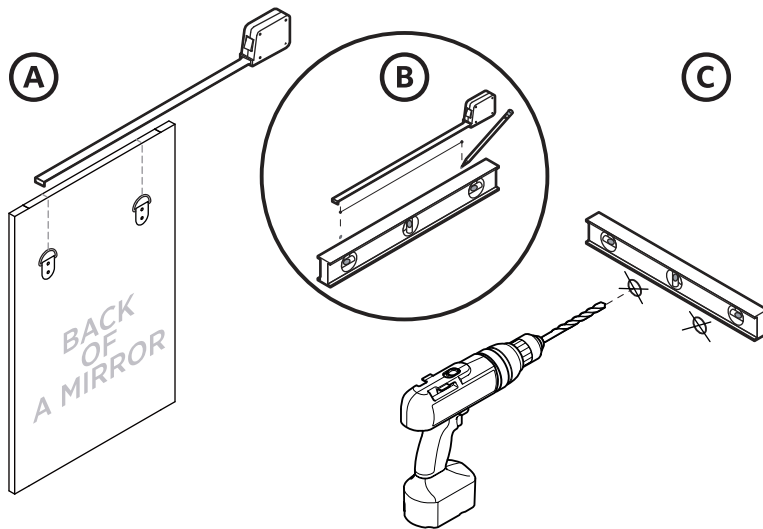

- 2** Press the anchors in the holes then insert screws with a drill or a screwdriver leaving just a tip outside of a wall.

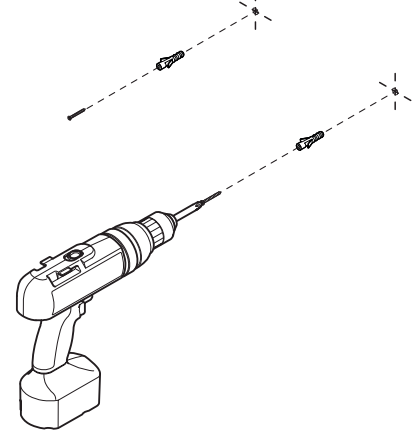

IMPORTANT: Consult an expert for the proper screws/bolts to use when attaching to various constructions. Screws provided do not attach to all wall construction types. Anchors are not required if brackets are installed in stud.

- 3** Hang a mirror on the wall.

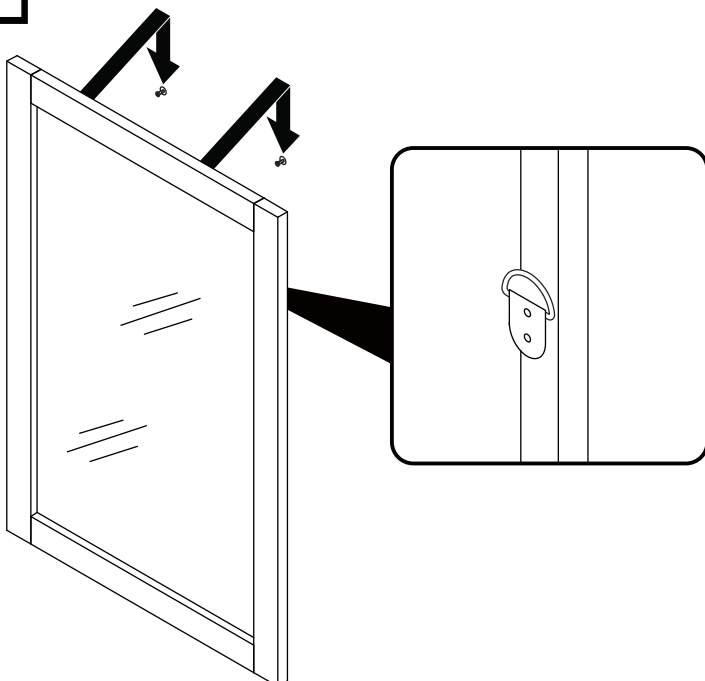

- 4** Repeat the steps for the next mirror.

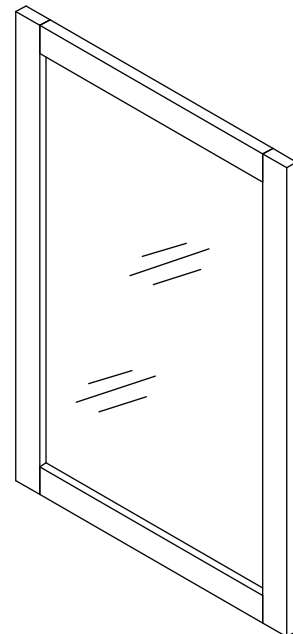

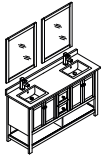

FVN2372-D MANCHESTER INSTALLATION GUIDE



CABINET AND SINK INSTALLATION

1 Attach a cabinet to the wall with the screws.

IMPORTANT: Consult an expert for the proper screws/bolts to use when attaching to various constructions, Screws provided do not attach to all wall construction types. Anchors are not required if brackets are installed in stud.

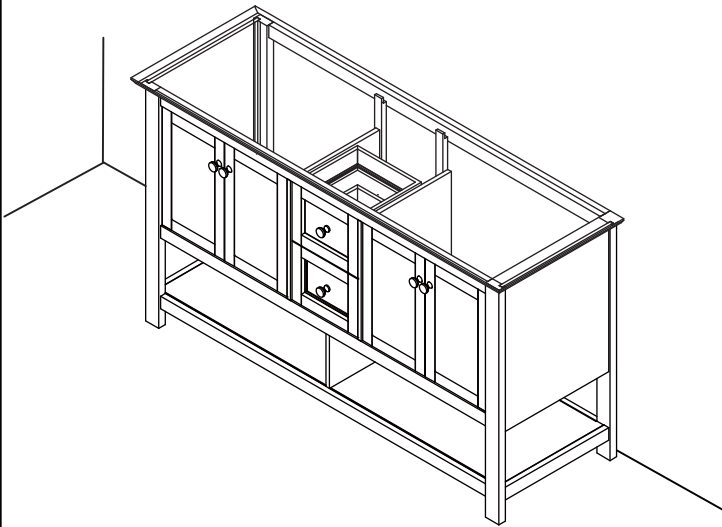

2 Attach a sink to the counter top with provided screws and brackets.

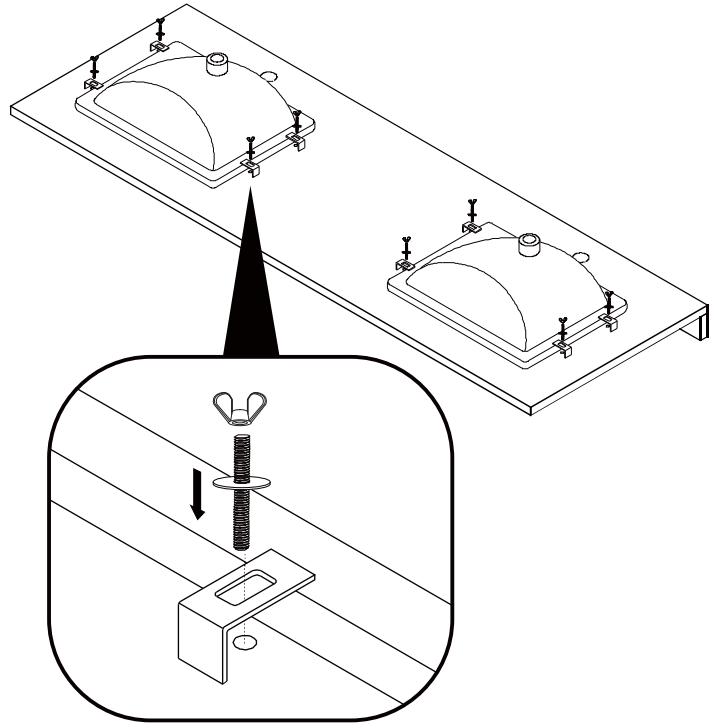

3 Connect a faucet to counter top. Apply a bead of silicone on the top of a cabinet (**B**) and place a sink (**A**) on it.

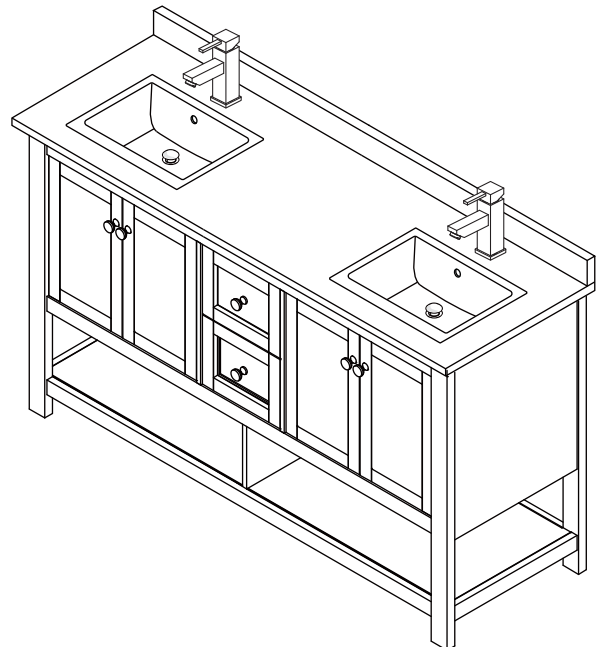
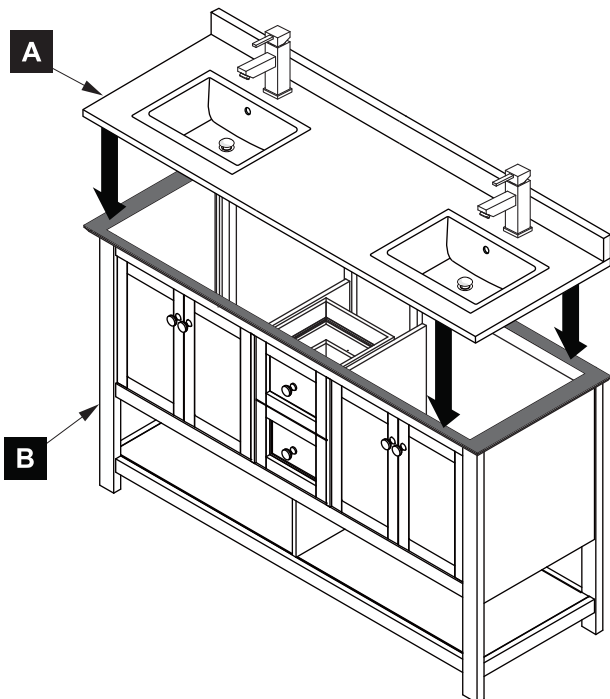

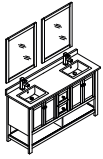

FVN2372-D MANCHESTER INSTALLATION GUIDE



DRAWER REMOVAL & INSTALLATION

DRAWER REMOVAL

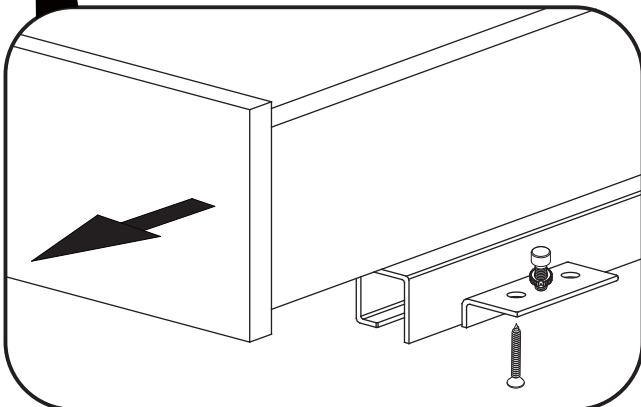
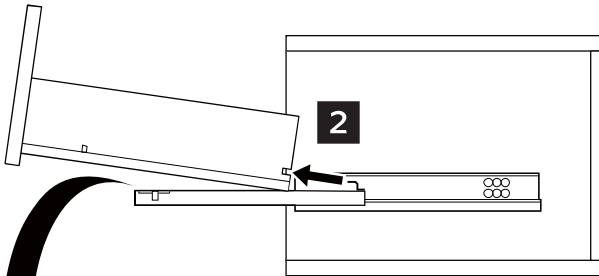
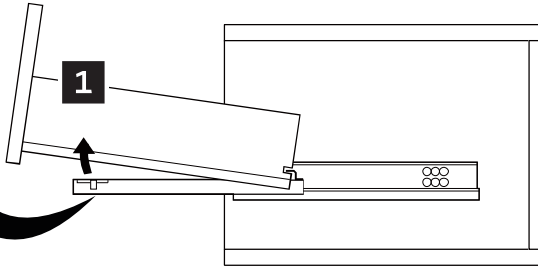
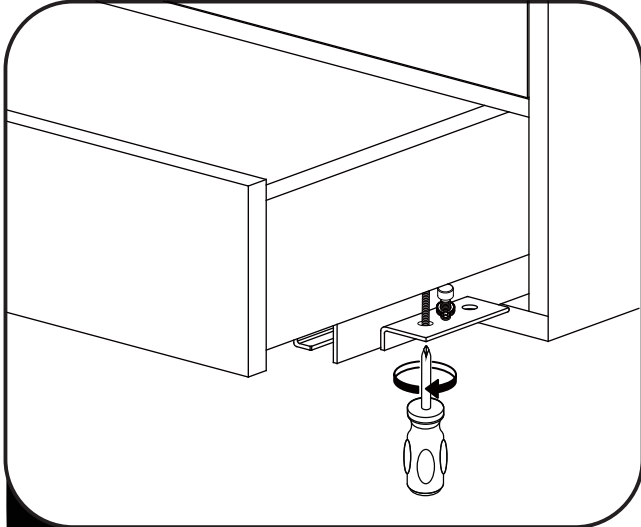

DRAWER INSTALLATION

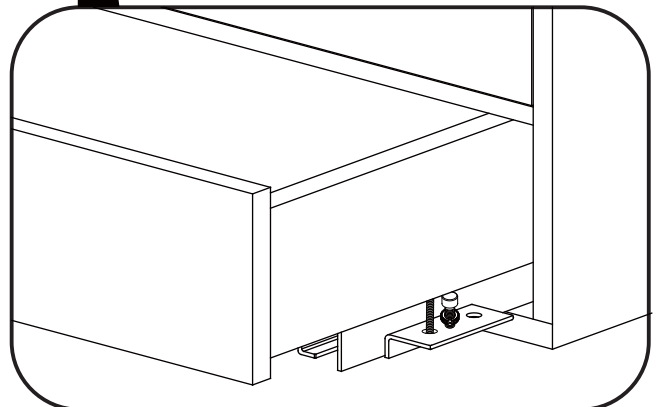
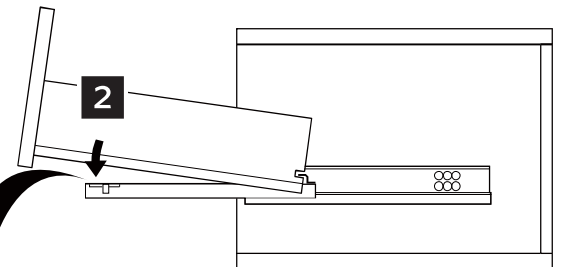
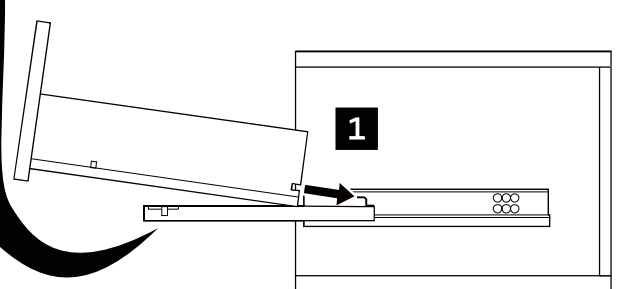
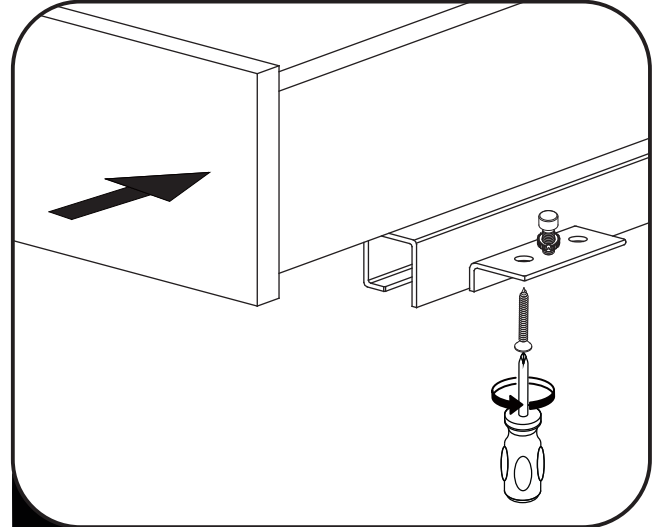

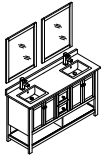

FVN2372-D MANCHESTER INSTALLATION GUIDE



P-TRAP & POP UP INSTALLATION

Your item may appear slightly different from the illustration.

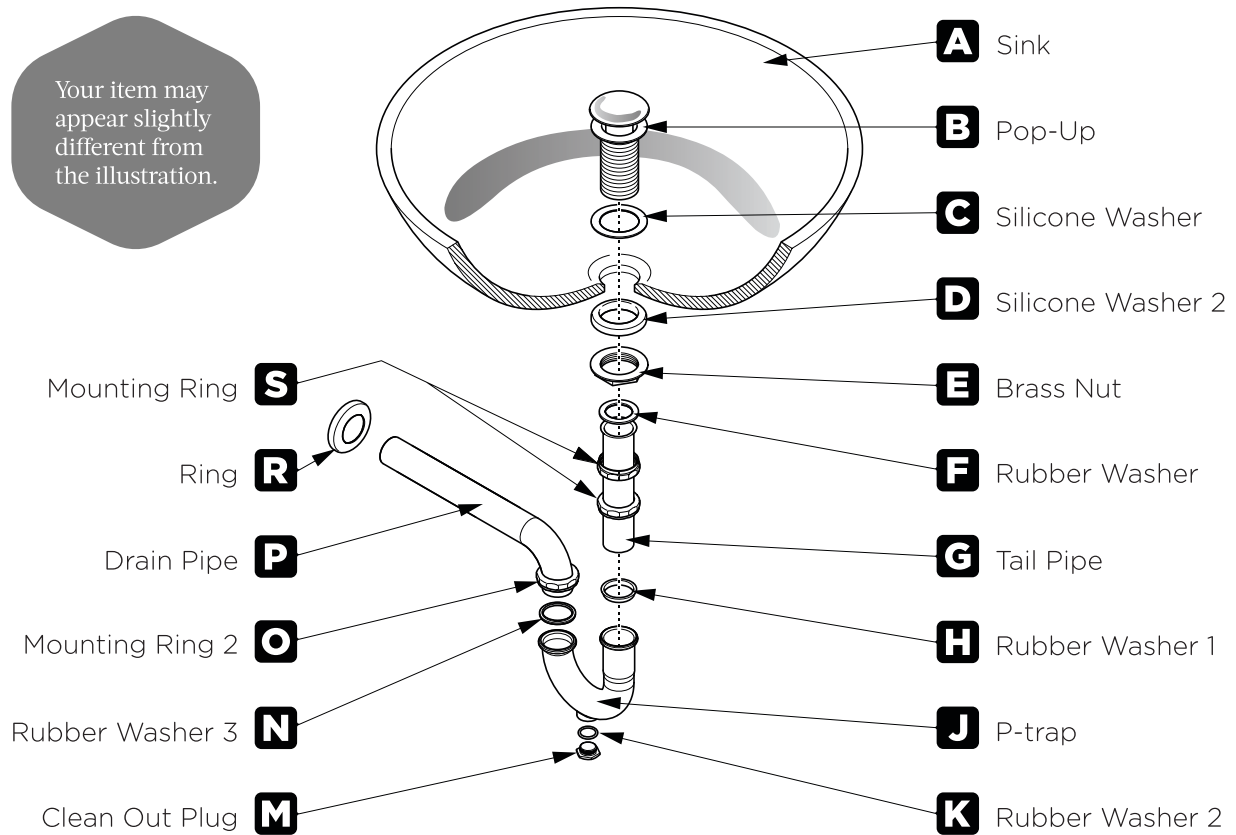

POP UP INSTALLATION

**FOR SINKS
WITHOUT OVERFLOW**

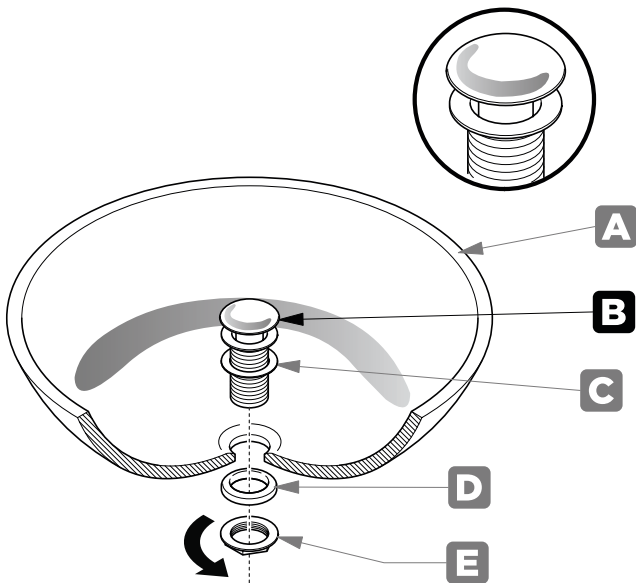

OR

**FOR SINKS
WITH OVERFLOW**

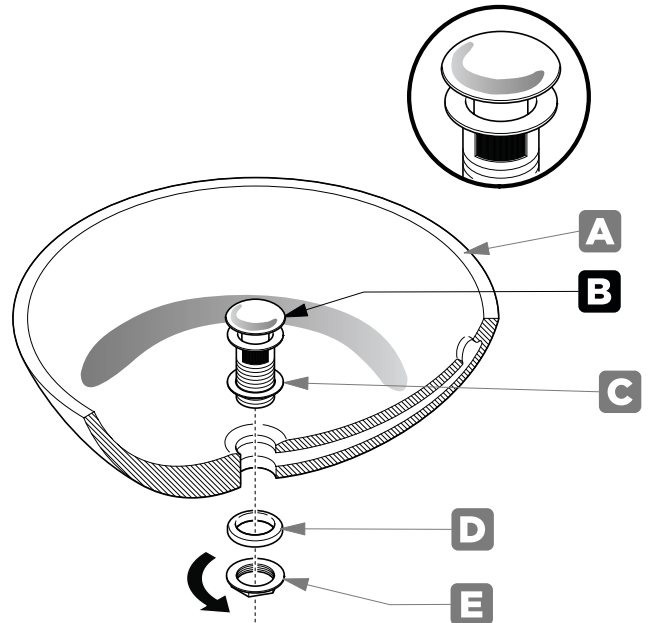

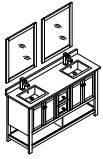

FVN2372-D MANCHESTER INSTALLATION GUIDE



P-TRAP INSTALLATION

1 Install a tail pipe (G).

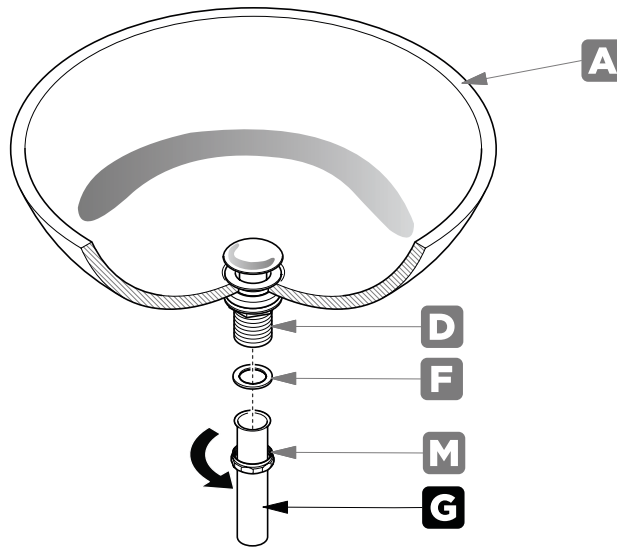

2 Connect a P-trap (J).

