

Important safety instructions:

- Please read carefully all instructions before assembling.
- For your safety and ease, assembly by two or more adults is recommended.
- Keep instructions for future use.



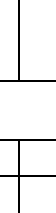

Pre-assembly:

- Do not discard any content until assembly is completed to avoid accidentally discarding small parts or hardware.
- Remove all parts and hardware from box along with any protective packaging.

Parts List

| Item | Description | DRAWING | QTY |
|------|-------------|---|-----|
| P1 | LEGS |  | 4 |
| P2 | CHAIR |  | 1 |

Hardware List

| Item | Description | DRAWING | QTY |
|------|------------------------|---|-----|
| H1 | Bolts φ5/16*2-3/16" |  | 8 |
| H2 | Lock Washers φ5/16" |  | 8 |
| H3 | Flat Washers φ5/16" |  | 8 |
| H4 | Allen Wrench φ1/4" |  | 1 |

Disclaimer:

When properly assembled, this item is safe for intended use. Seller is not liable for any damages resulting from item being improperly assembled after purchase.

Step 1. Assemble the chair on a flat and soft surface either on a carpet or cloth to prevent the finish from scratching. To locate the hardware, please turn the chair upside down, you will find the components beneath the fabric cover that is secured by a Velcro strap underneath the seat cushion. Lift the strap upwards, legs and hardware box could be located beneath the fabric cover.

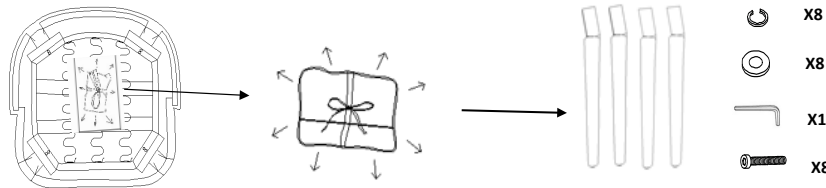

Step 2. Using bolts (H1), lock washers (H2), flat washers (H3), connect legs (P1) to chair (P2). Tighten bolts (H1) with allen wrench (H4).

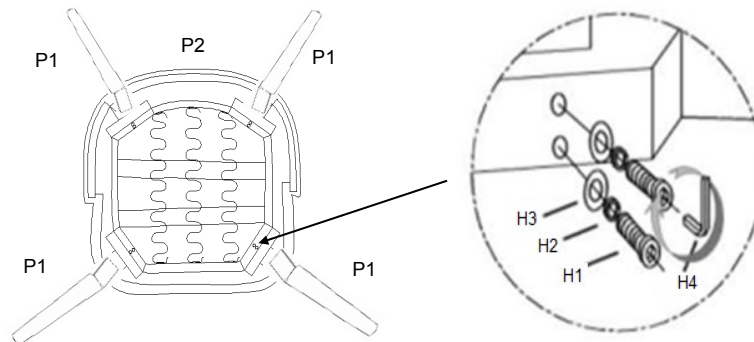

Step 3. Place chair upright on a level surface. Assembly is complete.

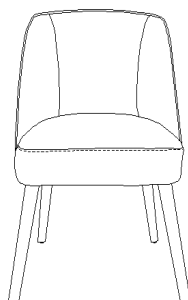

ADDITIONAL NOTE ABOUT SAFETY:

BOLTS MAY LOOSEN DURING NORMAL EVERYDAY USE.

THEY SHOULD BE INSPECTED AT LEAST EVERY 3 MONTHS AND RE-TIGHTENED AS NEEDED TO PREVENT DAMAGE OR INJURY, AND ENSURE STABILITY.

Thank you for your purchase