

Features

- Dual control wall-mounted.
- Lever handles.
- Stationary spout.
- Less drain.
- 6-1/4" (159 mm) 35° spout from wall to center of drain.
- 1.2 gal/min (4.5 l/min) maximum flow rate [max at 60 psi (4.14 bar)].

Material

- Brass construction.

Required Products/Accessories

K-410-K Wall-mount Valve

Optional Products/Accessories

K-7107 Decorative Drain
K-7108 Decorative Drain
K-7114 Pop-Up Drain
K-7124 Pop-Up Clicker Drain
K-7127 Drain
K-7129 Drain



ADA CSA B651 OBC

Codes/Standards







ASME A112.18.1/CSA B125.1
NSF/ANSI 61
NSF/ANSI 372
All applicable US Federal and State material regulations
DOE - Energy Policy Act 1992
EPA WaterSense®
California Energy Commission (CEC)
ADA
ICC/ANSI A117.1
CSA B651
OBC

KOHLER® Faucet Lifetime Limited Warranty

See website for detailed warranty information.

Available Colors/Finishes

Color tiles intended for reference only.

Color	Code	Description
	CP	Polished Chrome
	SN	Vibrant® Polished Nickel
	BGD	Vibrant® Moderne Brushed Gold
	BN	Vibrant® Brushed Nickel
	BV	Vibrant® Brushed Bronze
	BL	Matte Black

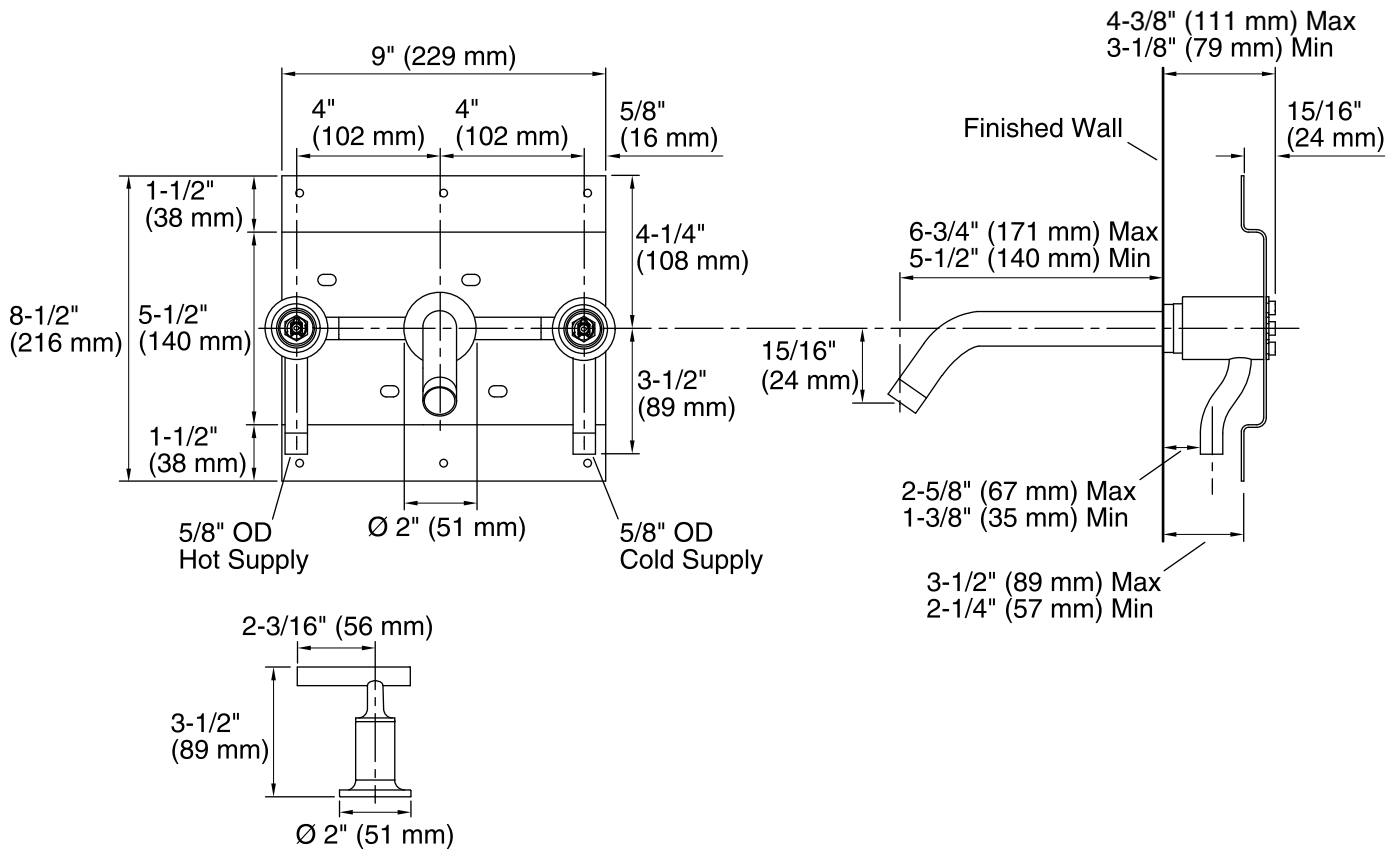

Technical Information

All product dimensions are nominal.

Faucet:

Flow rate: 1.2 gal/min (4.5 l/min)

Pressure: 60 psi (4.1 bar)

Spout:

Spout reach: 6-3/4" (171 mm)

Handle clearance: 2-3/16" (56 mm)

Notes

Install this product according to the installation guide.

The distance between the bottom of spout and top of the fixture rim must not be less than 1-1/2" (38 mm) and not greater than 6" (152 mm).

Three 1-1/2" (38 mm) diameter cutout holes are required for spout and handles.

ADA, OBC, CSA B651 compliant when installed to the specific requirements of these regulations.