

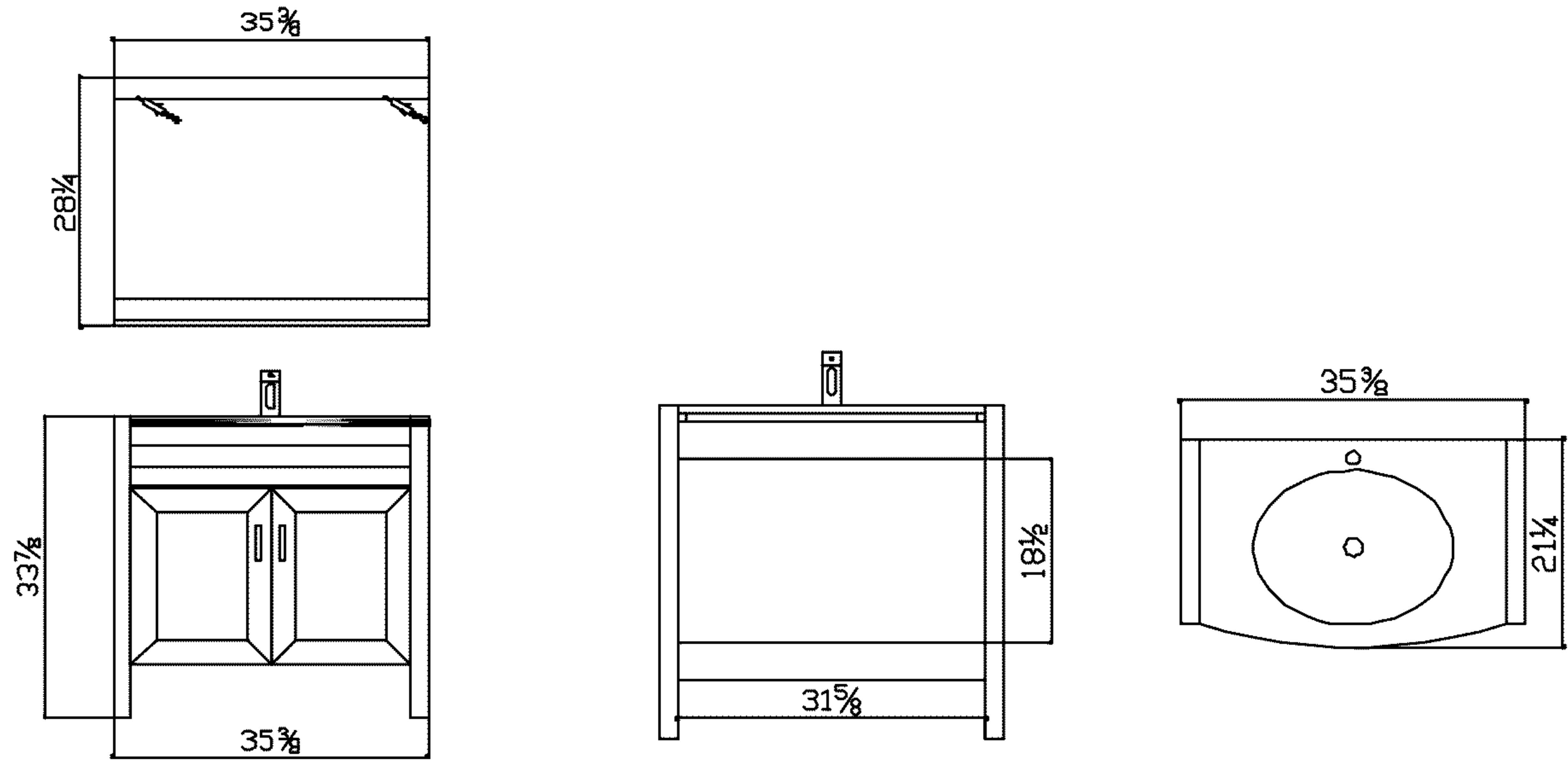

.Prior to installation please check received items against the Packing List Please report any missing items to your local dealer immediatelo.

.Protect all surfaces from sharp objects,high heat sources,direct prolonged sunlight and chemical hazards.

.Professional installation recommended.

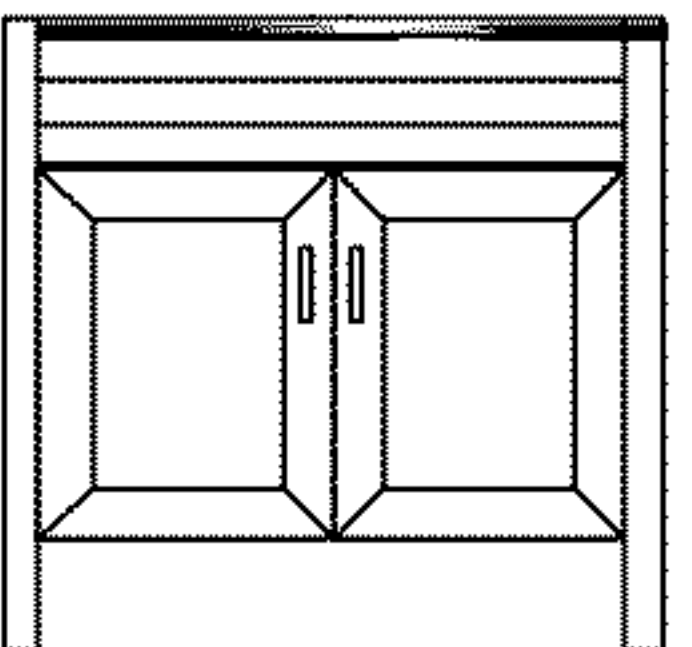
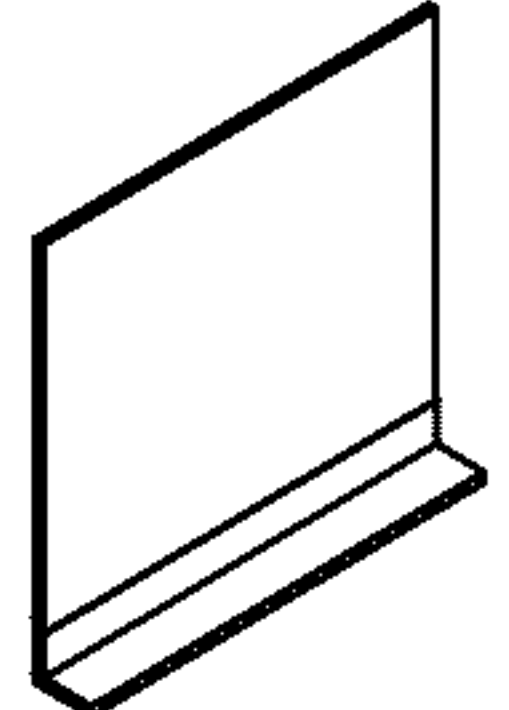
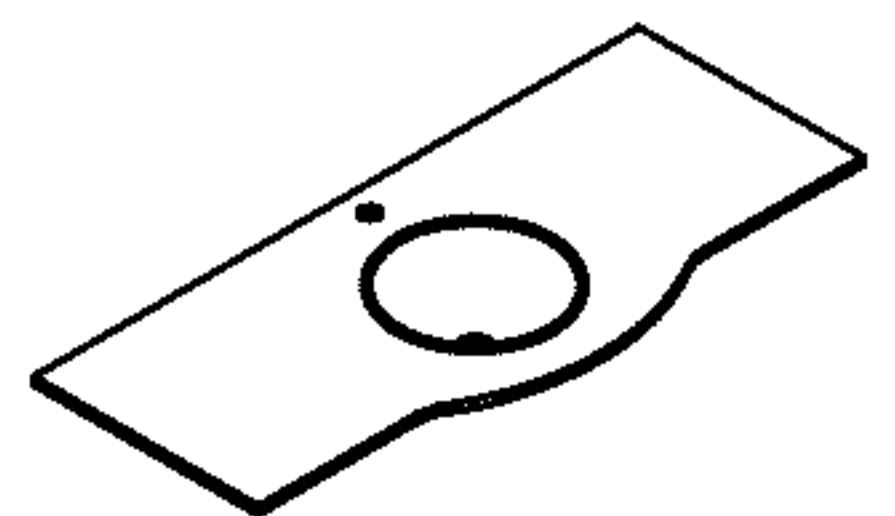
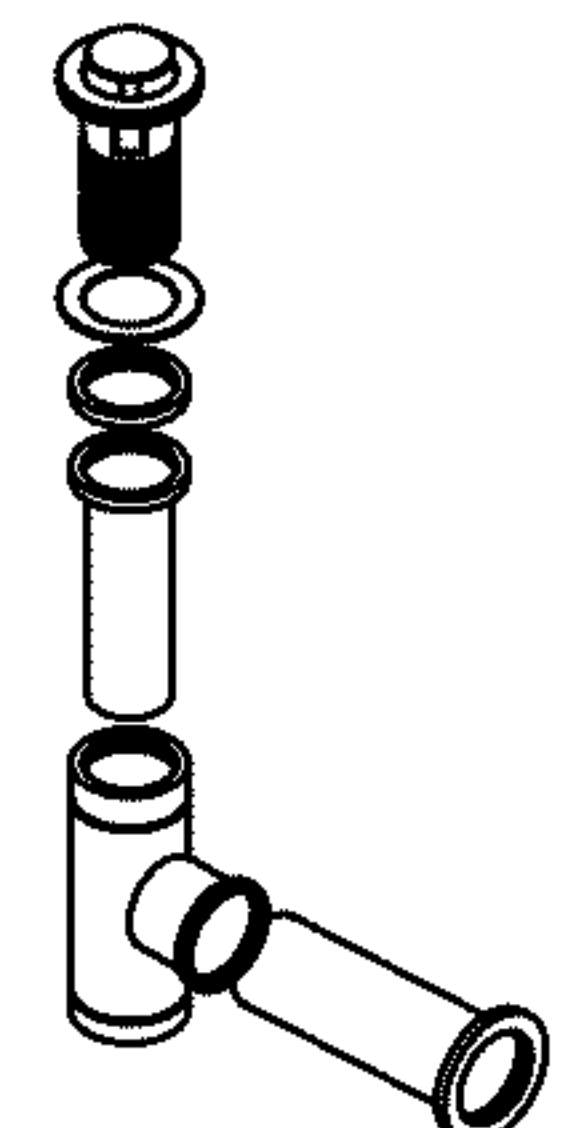
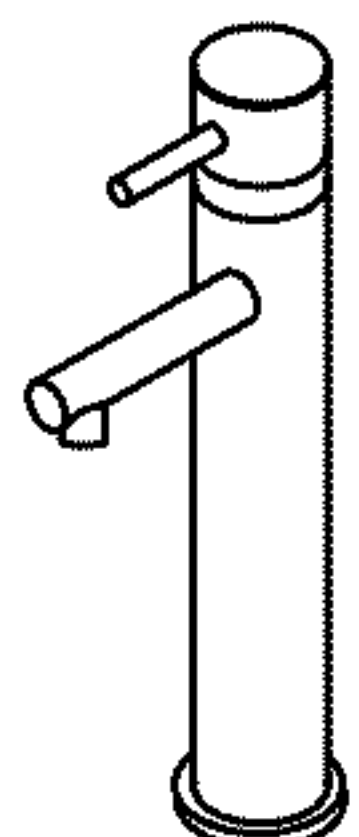

PACKING LIST

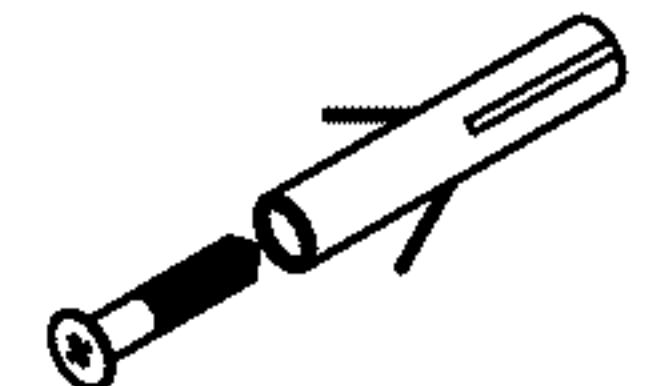
- | | | | | | | |
|--|--|--|---|--|--|---|
| <p>1. Main cabinet</p>  | <p>2. Mirror</p>  | <p>3. Basin</p>  | <p>4. Pop up+Drain pipe</p>  | <p>5. Faucet</p>  | <p>6. Screws</p>  | <p>7. Install screw</p>  |
|--|--|--|---|--|--|---|

REQUIRED TOOLS

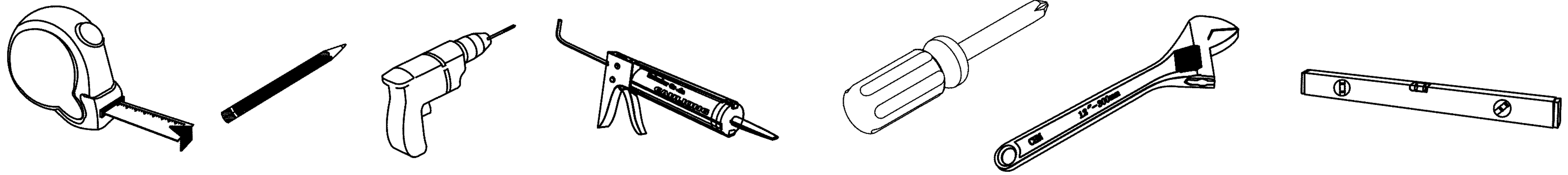

INSTALLATION AND ADJUSTION OF HINGE

