

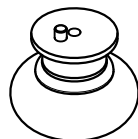

(G)

x1 Support leg *
 x1 Pattes centrales
 x1 Patas centrales



(H)

x3 Front Legs *
 x3 jambes
 x3 Piernas

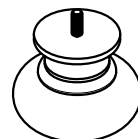

(I)

x2 Back Legs *
 x2 jambes
 x2 Piernas



(A)

x3 Bolt 5/16*80mm *
 x3 Boulon
 x3 Perno



(B)

x3 Lock washer 5/16mm *
 x3 Rondelle de blocage
 x3 Arandela de Seguridad

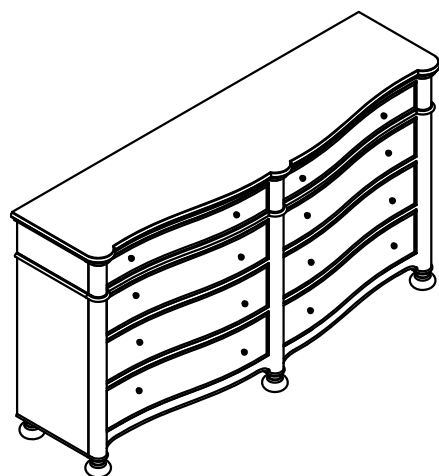

(C)

x3 Flat Washer 5/16*16mm *
 x3 Rondelle plate
 x3 Arandela plana



(D)

x1 Allen Wrench 73*29*5mm *
 x1 Clé hexagonale
 x1 Llave Allen

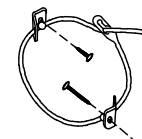

(E)

x1 Tipping restraint *
 x1 Liste des pièces de quincaillerie antibasculément
 x1 Abrazadera antivuelco

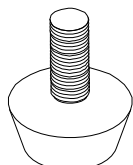

(F)

RC-FG-WHITE
 x4 Adjustable leveler-White *
 x4 Patin réglable
 x4 Nivelador ajustable

* Replaceable Part

▲ WARNING	
	<p>Children have died from furniture tipover. To reduce the risk of furniture tipover:</p> <ul style="list-style-type: none"> • ALWAYS install tipover restraint provided. • NEVER put a TV on this product. • NEVER allow children to stand, climb or hang on drawers, doors, or shelves. • NEVER open more than one drawer at a time. • Place heaviest items in the lowest drawers. <p><i>This is a permanent label. Do not remove!</i></p>

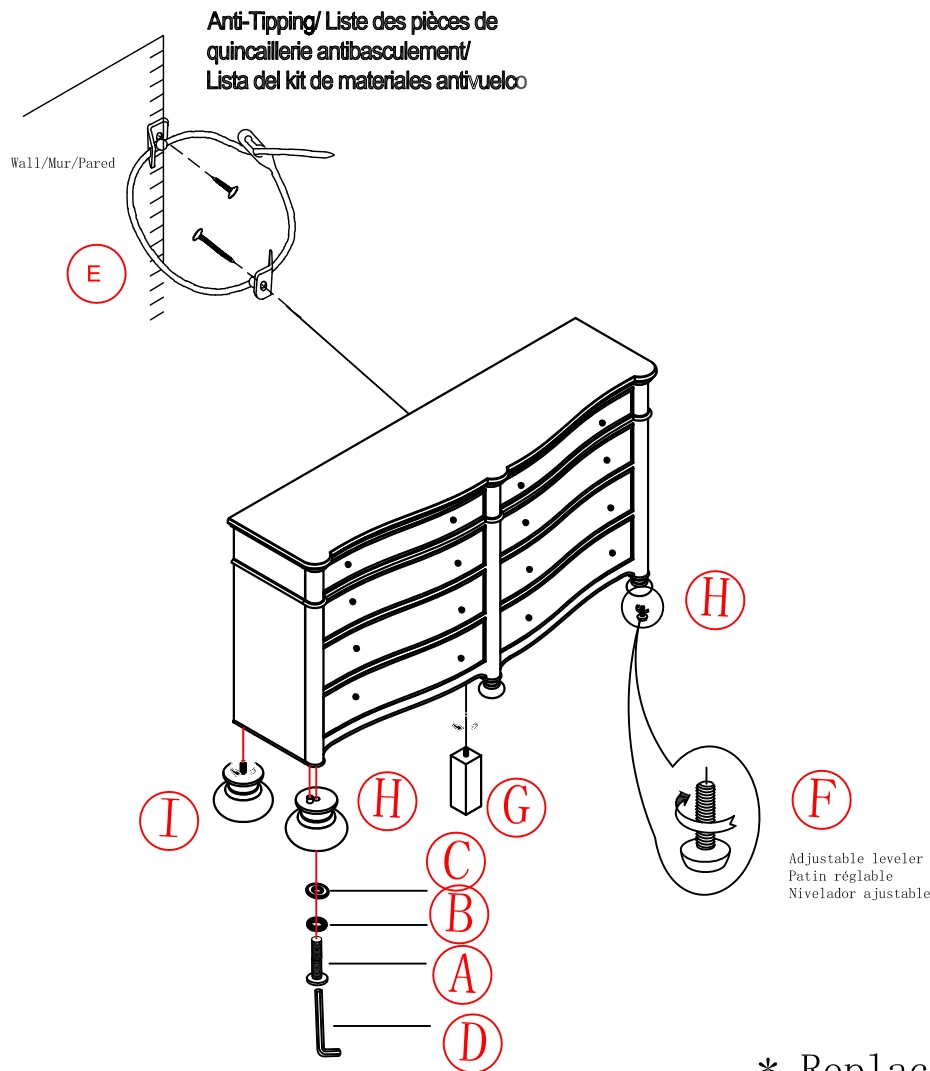

* Replaceable Part

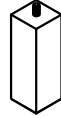

RP349100-CELEG *
x1 Support leg
x1 Pattes centrales
x1 Patas centrales

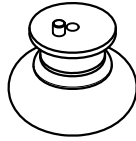

RP349100-FLEG *
x3 Front Legs
x3 jambes
x3 Piernas

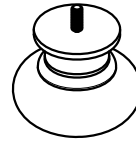

RP349100-BLEG *
x2 Back Legs
x2 jambes
x2 Piernas

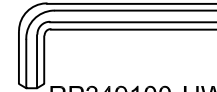
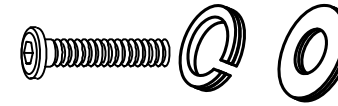

RP349100-HWKIT *
x1 Hardware Kit
x1 Liste des pièces de quincaillerie
x1 Lista del materiales

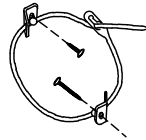

RC-ANTI-TIP *
x1 Tipping restraint
x1 Liste des pièces de quincaillerie antibasculément
x1 Abrazadera antivuelco

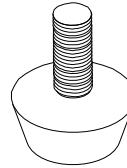

RC-FG-WHITE *
x4 Adjustable leveler-WHITE
x4 Patin réglable
x4 Nivelador ajustable

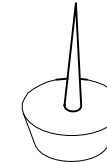

RC-WH-NAIL *
x2 Plastic Nail
x2 Clou en plastique
x2 Clavo de plástico

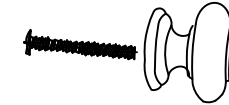

RP349100-KNOB *
x16 Knob with screw
x16 Tirer et vis
x16 Tire y Tornillo

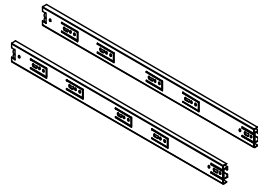
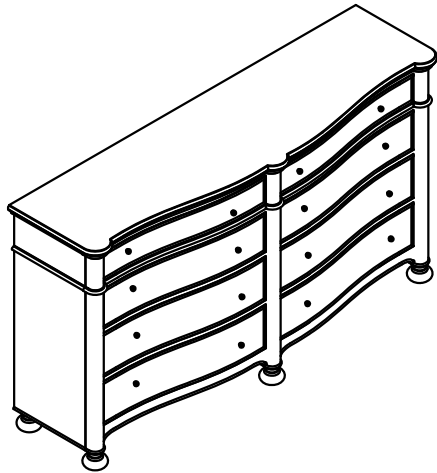

COMGLIDE-10-45 *
x8 Full Extension guides 10"L x 45mmW
x8 Rails à extension complète
x8 Rieles completamente extensibles

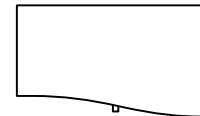

RP349100-LFELT *
x1 Removable Felt-Left&Black
x1 Feutre
x1 Fieltro

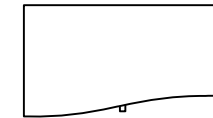

RP349100-RFELT *
x1 Removable Felt-Right&Black
x1 Feutre
x1 Fieltro

* Replaceable Part

Protect Your Wood or Laminate Flooring

*This statement applies to any floor without carpet.

If not careful, all furniture including upholstery and case pieces can scratch, scuff and even gouge floors. The recommendation is to have felt, rubber pads or area rugs under furniture on flooring without carpet.

Moving your furniture

Pushing and dragging furniture over floors without carpet can lead to scratches and scuffs. Have someone help when moving the larger pieces of furniture by lifting, try using a dolly or moving pads.

Felt and rubber pads

Applying furniture pads to the feet of furniture helps cushion contact points. Furniture pads can be found at local hardware stores. Felt pads slide easily across the floor, making them ideal for dining chairs and other pieces that move with use. Rubber pads will help furniture stay in place and are perfect for larger pieces, like sofas and loveseats.

Area rugs and rug pads

Using an area rug under furniture is another way to protect your floor from scratches and scuff marks. A rug pad under the area rug will provide extra cushion and added protection.