

Deco Motion Club Chair

Model: OP-PECLB2M-DEC

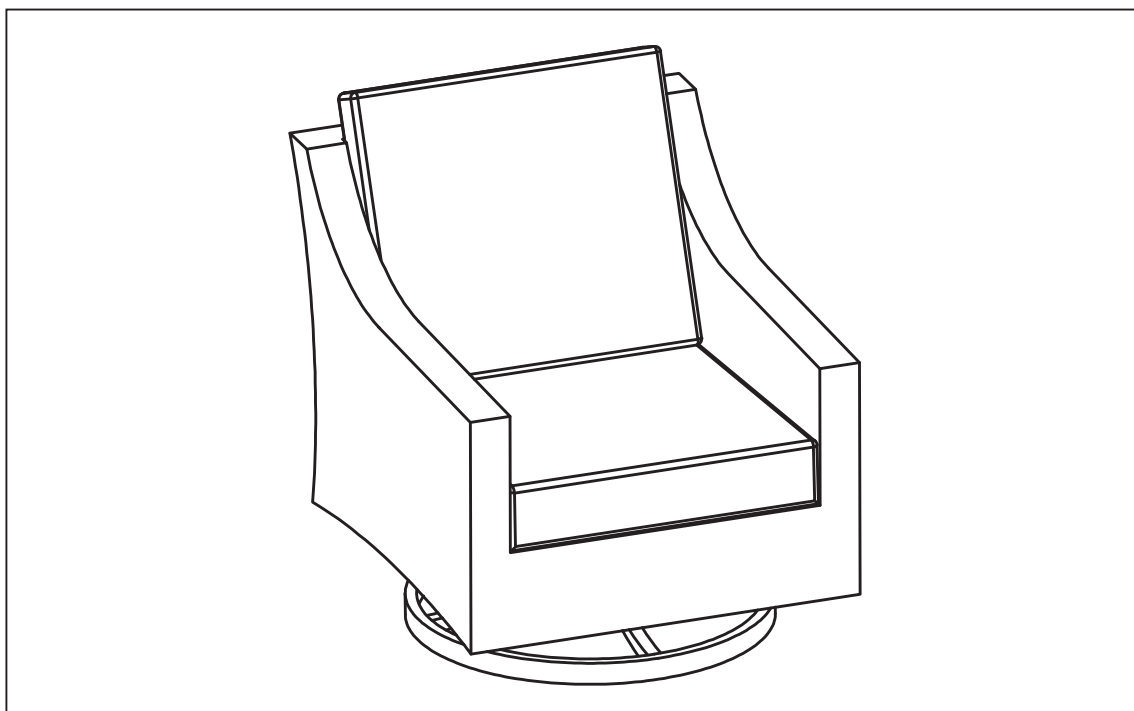





ASSEMBLY INSTRUCTIONS

**IMPORTANT, RETAIN FOR FUTURE REFERENCE.
READ CAREFULLY.**

For assistance with assembly or customer service,
call 1-877-924-2090 (English) Monday-Friday, 8 a.m. to 5 p.m. Mountain
Time, North America. Email: customerservice@rstbrands.com or visit
our website at www.rstbrands.com

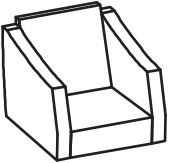
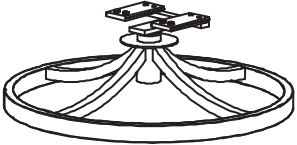
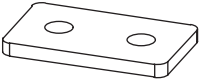
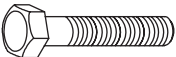

PARTS LIST

NO	PICTURE	PART DESCRIPTION	QTY.
A		Chair	1
B		Base	1
C		Metal plate	4
D		Bolt (M8 x 45)	4
E		Washer (Ø16 *Ø8.4*1.6)	4
F		Lock washer (Ø8.1*2.1*H4.2)	4
G		Nut (M8)	4
H		Wrench	2

ATTACH BASE TO CHAIR

Step 1.

1. Place the metal plates (C) on the top of the chair frame (A) and below the support plate on the chair base (B).
2. Attach the chair (A) to the base (B) feeding bolts (D) and washers (E) through the top of the chair frame, and securing with washers (E), lock washers (F), and nuts (G) from the bottom of the chair base.
3. Tighten with wrenches (H).

•Wait until all the screws are in position before tightening them

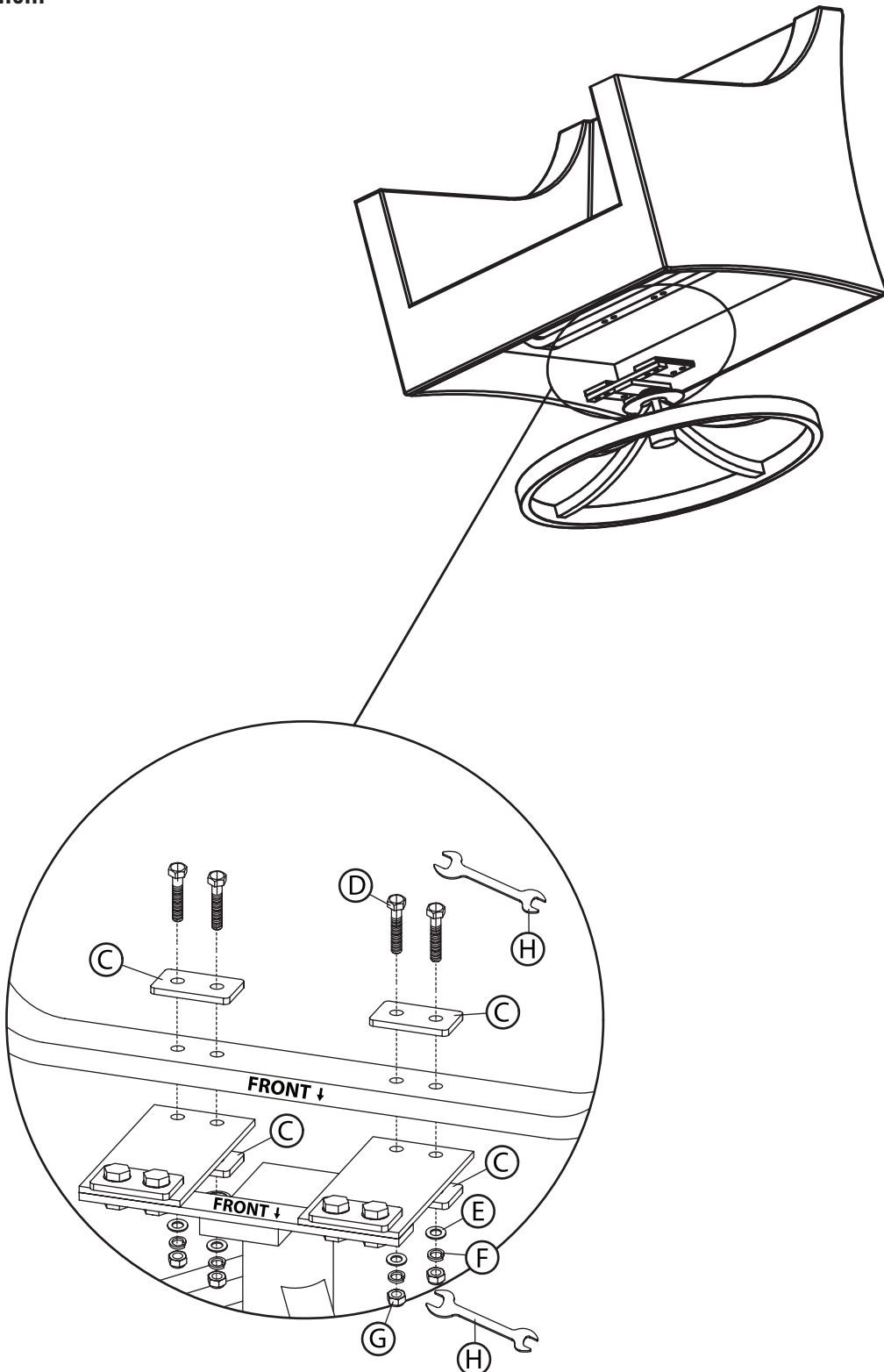

Care and Maintenance

All outdoor furniture is subject to UV rays and weather elements. In order to keep your furniture as long lasting and vibrant as possible, we advise using furniture covers or storing the furniture when not in use. For more information about the materials used to make our furniture please visit www.rstbrands.com/details-landing

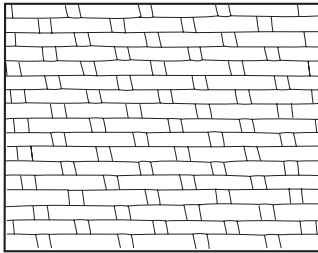

WICKER

Simply washing your wicker with a mild detergent and protecting it as much as possible by covering and or storing it when not in use for long periods of time is sufficient.

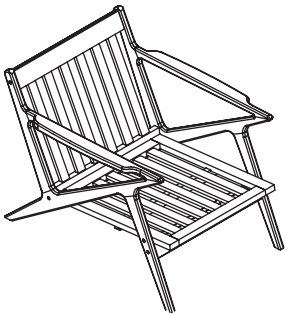

WOOD FRAMES

Make sure all surfaces are protected from heat and liquids. Wipe up spills immediately and do not place furniture next to a heat source such as radiators or fires. All timber surfaces may change color. Spray polishes are best to avoid as they contain silicones which may spoil the surface by building up overtime. Check bolts and screws regularly and tighten when necessary.

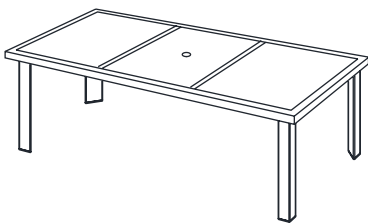

STONE TOPS/ TABLE TOPS

Spills should be wiped up quickly to avoid any staining on the surface. Regular cleaning with mild soap and water with a sponge or soft scrub brush is all that is required. Storing or covering your natural stone top when not in use for extended periods of time is recommended.

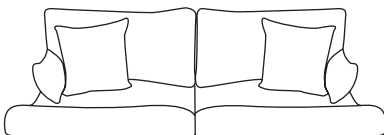

FABRICS

Wipe off spills with a cloth and water. RST Brands uses Sunbrella® fabrics designed to protect and last for several years. Sunbrella fabrics are treated with a proprietary water and stain repellent. If needed to revive fabrics Glen Raven® recommends 303® Fabric Guard™. For more information visit www.303products.com and follow instructions on the container.

Deco Motion Club

Modèle: OP-PECLB2M-DEC

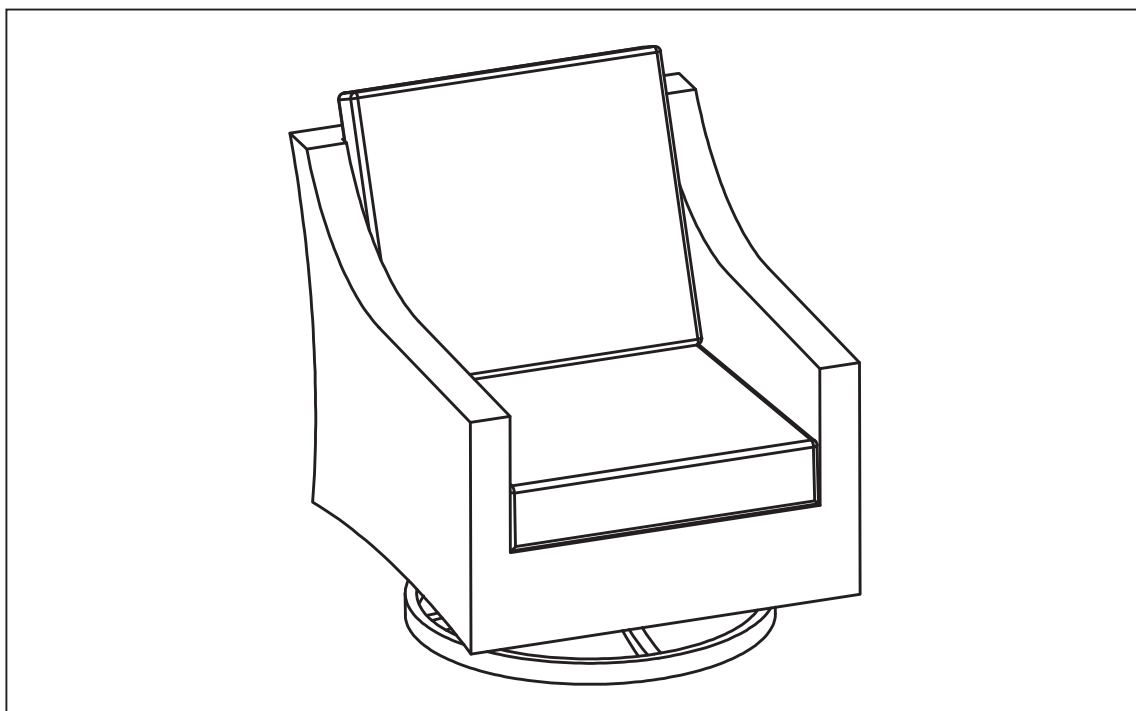





INSTRUCTION D'ASSEMBLAGE

IMPORTANT, À CONSERVER À TITRE DE RÉFÉRENCE. À LIRE ATTENTIVEMENT.

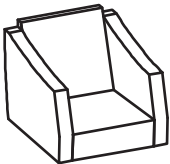
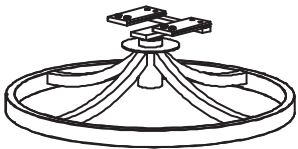
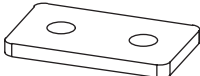
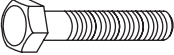
Pour de l'aide à l'assemblage ou le service à la clientèle, composez le 1-877-924-2090 (Anglais)
Lundi - Vendredi 8 heures - 17 heures, heure des Rocheuses, en Amérique du Nord. Émail: customer-service@rstbrands.com ou visitez notre site Web @ rstbrands.com

LISTE DES PIÈCES

NO	IMAGE	RÉFÉRENCE DESCRIPTION	QTE.
A		Chaise	1
B		Base	1
C		Plaque de métal	4
D		Boulon (M8 x 45)	4
E		Rondelle (Ø16 *Ø8.4*1.6)	4
F		Rondelle de blocage (Ø8.1*2.1*H4.2)	4
G		Écrou (M8)	4
H		Clé	2

Étape 1.

ATTACHER LA BASE À LA CHAISE

1. Placez les plaques métalliques (C) sur le dessus du cadre de la chaise (A) et sous la plaque de support sur la base de la chaise (B).
2. Fixez le fauteuil (A) à la base (B) en insérant les boulons (D) et les rondelles (E) dans la partie supérieure du cadre du fauteuil et fixez avec les rondelles (E), les rondelles frein (F) et les écrous (G) du bas de la base du fauteuil.
3. Serrer avec des clés (H).

• Attendez que toutes les vis soient en place avant de les serrer

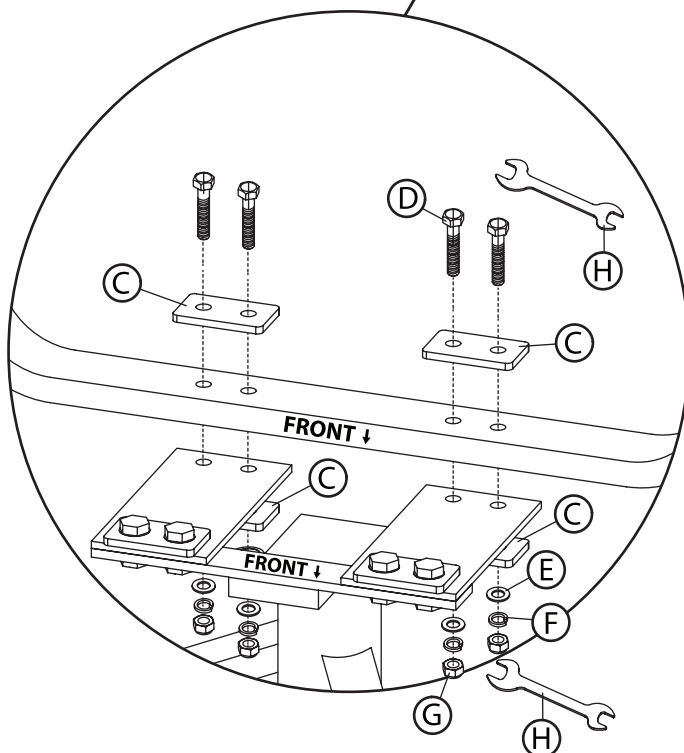
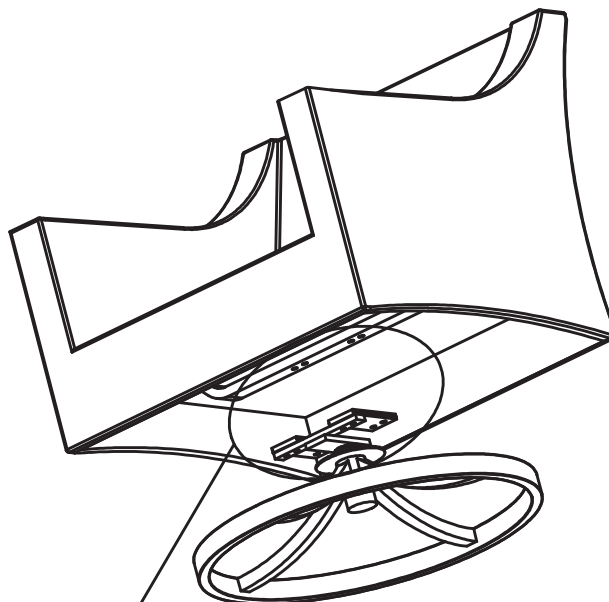

Soins et Entretien

Tout meuble à l'extérieur est soumis aux rayons UV ainsi qu'aux éléments météorologiques. Afin de préserver vos meubles aussi longtemps et aussi vibrants que possible, nous vous conseillons de les couvrir ou de les garder à l'intérieur lorsqu'ils ne sont pas utilisés. Pour plus d'informations sur les matériaux utilisés pour fabriquer nos meubles, veuillez visiter www.rstbrands.com/details-landing

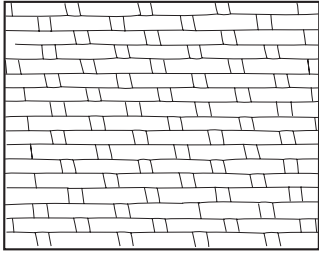

OSIER

Laver simplement vos meubles en osier avec un détergent léger, en les protégeant autant que possible en les couvrant ou en les gardant à l'intérieur lorsqu'ils ne sont pas utilisés, est suffisant.

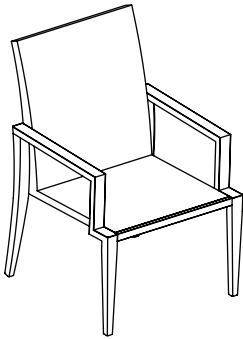

CADRES EN ALUMINIUM

Les meubles RST Brands incorporent des cadres recouverts en aluminium qui sont conçus pour nécessiter un entretien minimum. Évitez de laisser trop de poussière s'empiler en les lavant avec du savon doux et de l'eau. Ne laissez jamais de meuble sous l'eau.

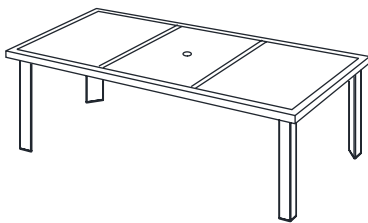

SURFACES EN PIERRE / DESSUS DE TABLE

Les liquides renversés doivent être nettoyés rapidement pour éviter toute tache sur la surface. Un lavage régulier avec un savon doux et de l'eau en utilisant une éponge ou une brosse souple est l'unique chose requise. Ranger ou couvrir votre surface en pierres naturelles lorsqu'elle n'est pas utilisée pendant une durée étendue est recommandé.

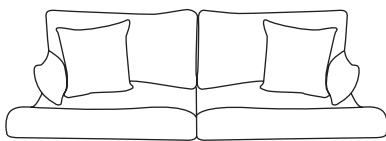

TISSUS

Nettoyez les liquides renversés avec un tissu et de l'eau. RST Brands utilise Sunbrella®, conçu pour protéger et durer pendant plusieurs années. Les tissus Sunbrella sont traités avec de l'eau et du produit anti-taches. Si nécessaire pour faire revivre les tissus, Glen Raven® recommande 303® Fabric Guard™. Pour plus d'informations, visiter www.303products.com et suivre les instructions présentes sur le conteneur.

Deco Motion Club

Modelo: OP-PECLB2M-DEC

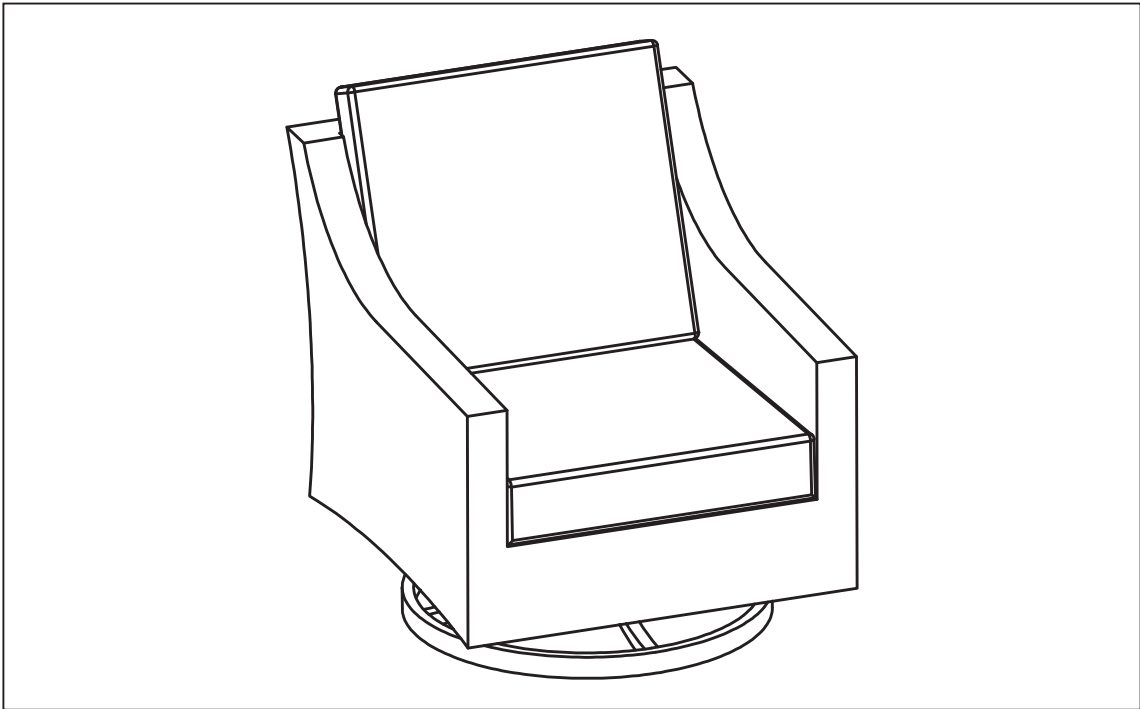





MANUAL DE INSTRUCCIONES Y ENSAMBLE

**IMPORTANTE, RETENER PARA FUTURAS CONSULTAS.
LEA CUIDADOSAMENTE.**

Para asistencia con el ensamblaje e instalación de las partes y servicio al cliente llame:
1-877-924-2090 (Inglés) Lunes-Viernes 8 a.m- 5 p.m. Hora de la Montaña, Norte América.
Póngase en contacto con nosotros por correo electrónico a
customerservice@www.rstbrands.com o visite nuestro sitio web en www.rstbrands.com.

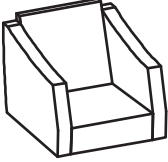
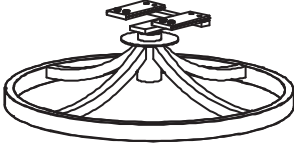
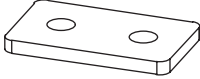
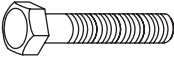

LISTA DE PARTES

NO	IMAGEN	DESCRIPCIÓN (PARTE)	CANT.
A		Silla	1
B		Base	1
C		Placa metálica	4
D		Perno (M8 x 45)	4
E		Arandela (Ø16 *Ø8.4*1.6)	4
F		Arandela de seguridad (Ø8.1*2.1*H4.2)	4
G		Tuerca (M8)	4
H		Llave	2

FIJE LA BASE A LA SILLA

Paso 1.

1. Coloque las placas de metal (C) en la parte superior del marco de la silla (A) y debajo de la placa de soporte en la base de la silla (B).
2. Fije la silla (A) a la base (B) empujando los pernos (D) y las arandelas (E) a través de la parte superior del marco de la silla, y asegure con las arandelas (E), arandelas de seguridad (F) y tuercas (G) desde la parte inferior de la base de la silla.
3. Apriete con las llaves (H).

• Espere hasta que todos los tornillos estén en su lugar antes de apretarlos

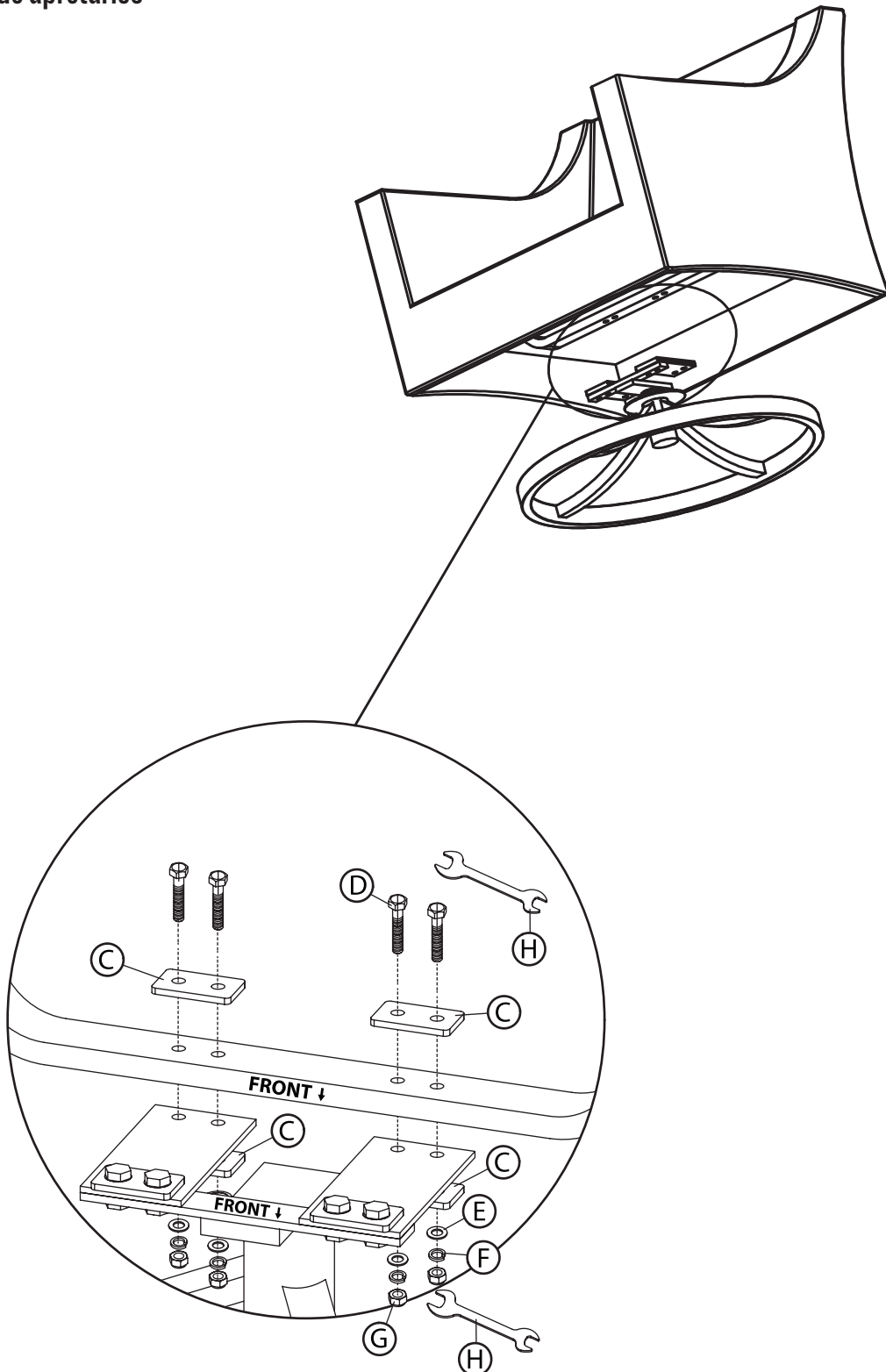

Cuidados y Mantenimiento

Todo mobiliario al aire libre está sujeto a los rayos ultravioleta y las inclemencias meteorológicas. Para que sus muebles duren y los colores se mantengan tan vibrantes como sea posible, aconsejamos cubrirlos o guardarlos cuando no estén en uso. Para obtener más información acerca de los materiales utilizados para fabricar nuestros muebles visite: www.rstbrands.com/details-landing

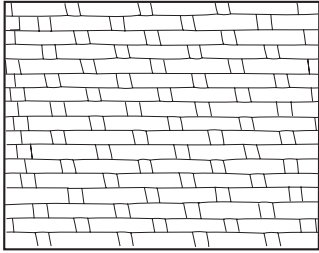

MIMBRE

Simplemente lave sus muebles de mimbre con un detergente suave y protéjalos cubriéndolos o guardándolos cuando no los use durante largos períodos de tiempo.

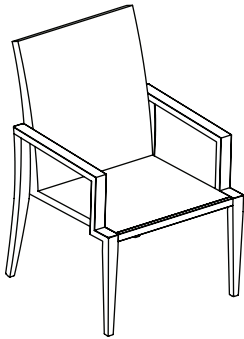

ESTRUCTURAS DE ALUMINIO

Los muebles de RST Brands están contruidos con estructuras recubiertas con polvo de aluminio diseñados para necesitar mantenimiento mínimo. Evite que se acumule demasiada suciedad limpiando con agua y jabón suave. Nunca deje muebles sobre el agua.

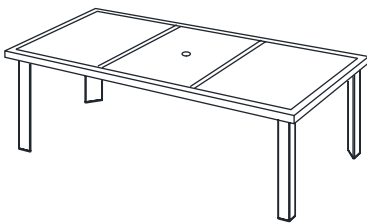

SUPERFICIES DE PIEDRA / MESA

Limpie los derrames rápidamente para evitar manchas en la superficie. La limpieza regular con agua y jabón suave con una esponja o cepillo es todo lo que se necesita. Se recomienda almacenar o cubrir la superficie de piedra natural cuando no está en uso durante períodos prolongados de tiempo.

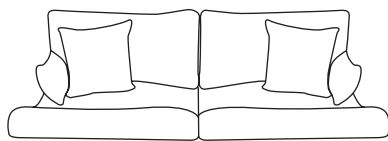

TEJIDOS

Limpie los derrames con un paño y agua. RST Brands utiliza tejidos Sunbrella® que están diseñados para proteger y durar varios años. Los tejidos Sunbrella se tratan con un repelente de agua y manchas de fórmula patentada. Si es necesario para reavivar los tejidos Glen Raven® se recomienda usar 303© Fabric Guard™. Para obtener más información, visite www.303products.com y siga las instrucciones en el envase.