

Model: Avro **Installation and User's Guide**

Freestanding Bathtub

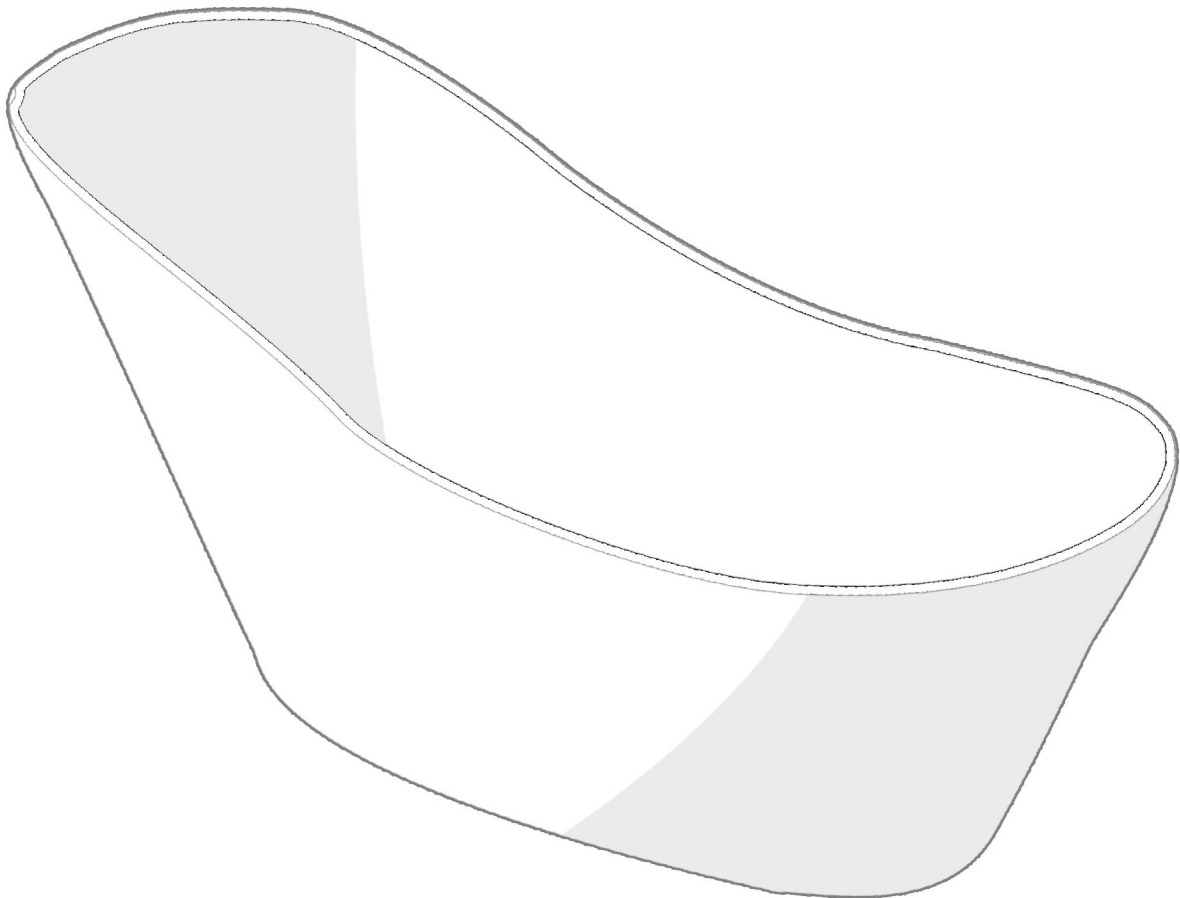

Read all instructions carefully before proceeding.

THANK YOU

We can assure you that Kitchen and Bath Masters has used the best materials and has applied the strictest quality control measures to ensure that each and every unit meets the highest quality standards. This booklet contains general information's about the unit as well as step-by-step installation instructions.

If you have any questions please call one of our sales specialists 773-383-4415

BEFORE BEGINNING

- Carefully read the instructions before beginning the installation.
- Observe all local plumbing and building codes.
- To protect the unit during installation, we recommend that you lay a piece of cardboard underneath the bathtub.
- Place the unit in the bathroom before you start working. If the unit is covered with a polyethylene protective film, do not remove it until the installation is complete for maximum protection. However, remove film where two surfaces will be in permanent contact.
- It is strongly recommended that this installation be performed by a professional plumber or contractor.
- A minimum of two people are needed to perform this installation.
- Provide a minimum of 1000 lbs floor support under the bathtub.
- The bathtub is designed for a freestanding installation only.

WARNING !

DO NOT SIT ON THE LEDGE OF THE BATHTUB

That might cause serious injury. Kitchen and Bath Masters is not responsible for defects and/or problems incurred under these circumstances.



TOOLS AND MATERIALS REQUIRED



Level



Tape measure



Pencil

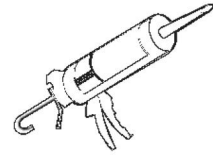

Silicone

COMPONENT IDENTIFICATION

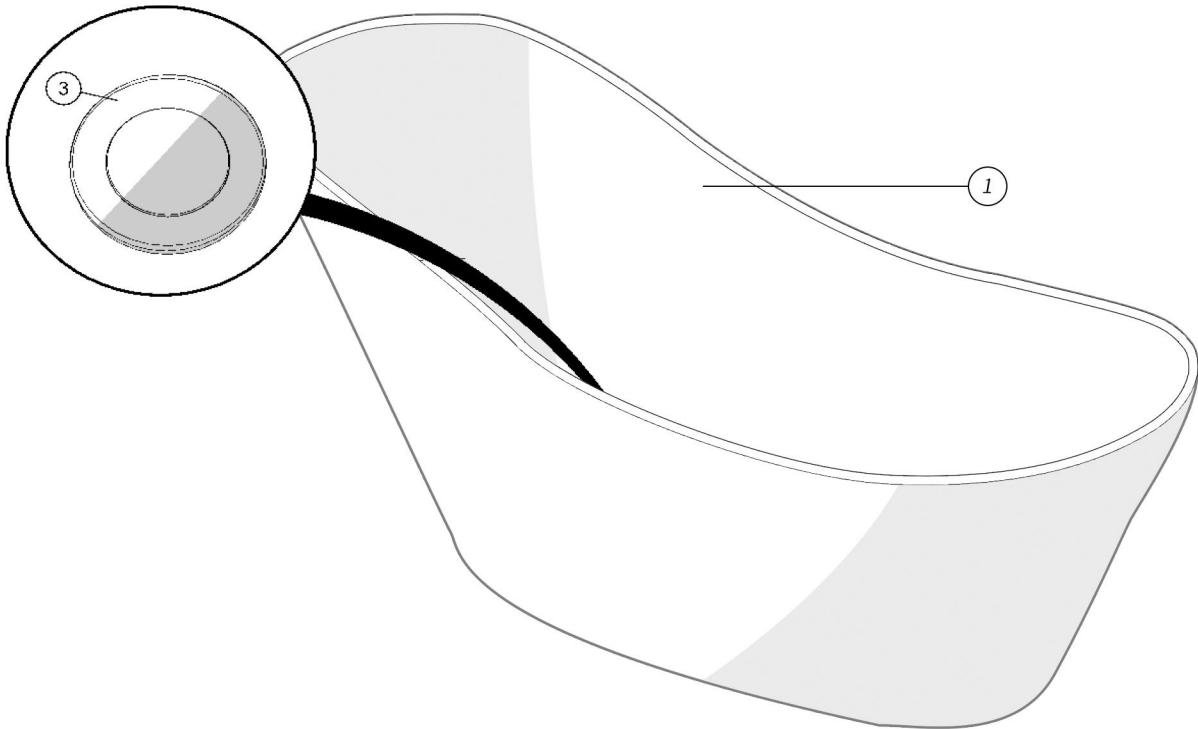

#	Part	Qty
1	Bathtub	1
2	Overflow	1
3	Drain	1
4	Hex Locknut	8
5	Adjustable Feet	4
6	Adjustable Feet Cap	4
7	Adjustable Thread	4
8	1½" Flanged Tailpiece Washer	1
9	1½" Tailpiece	1
10	1½" Slip Joint Nut	1

SPECIFICATIONS

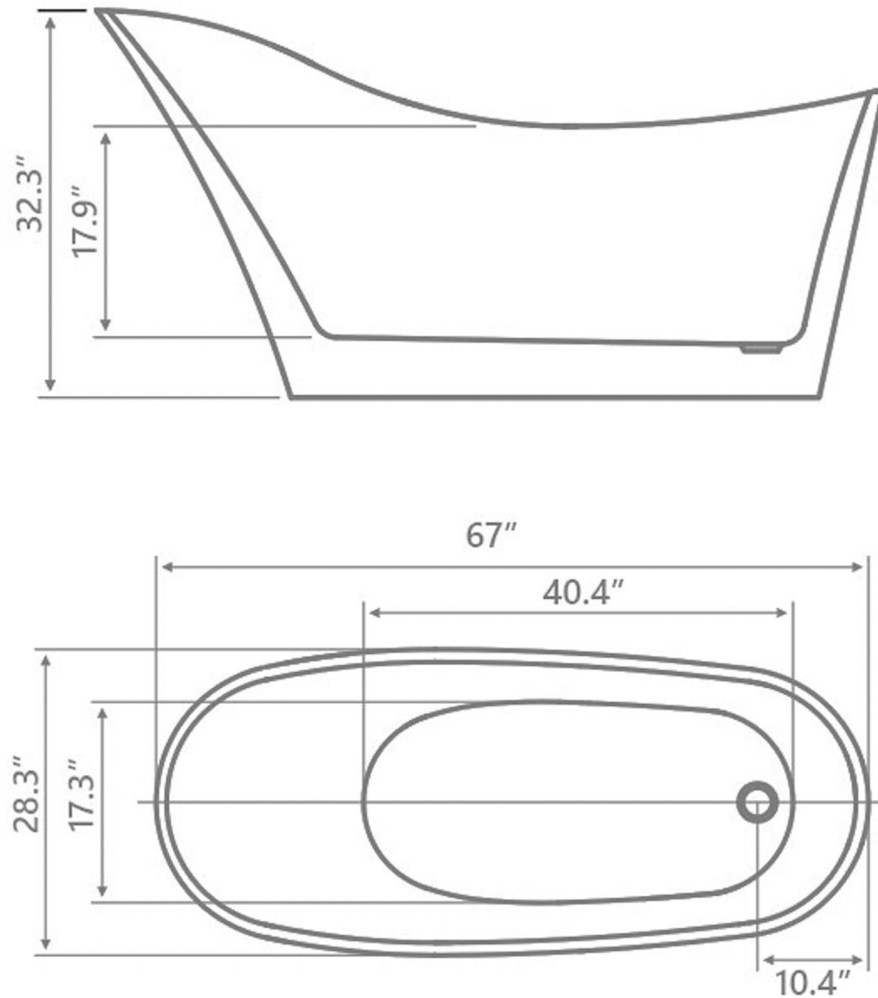

* Tolerance on dimensions: $\pm \frac{1}{4}$ " [6 mm]



BATHTUB INSTALLATION

1. PLUMBING

Install all plumbing and drainage before securing the unit. **It is always recommended to have a competent, professional plumber to do the plumbing installations.** Before drilling a hole in the floor for the drainpipe, make sure there are no hidden elements underneath (pipes, floor joists, heating ducts, electrical wires, etc.)

2. LEVELING

Once the unit is in position, ensure its level is adjusted in both directions for proper draining. Leveling must be done with the adjustable feet located beneath the unit. Adjust the feet so that they are 1/4" [6 mm] above the bottom rim of the bathtub. The bathtub's weight should be supported by the feet, not the rim.

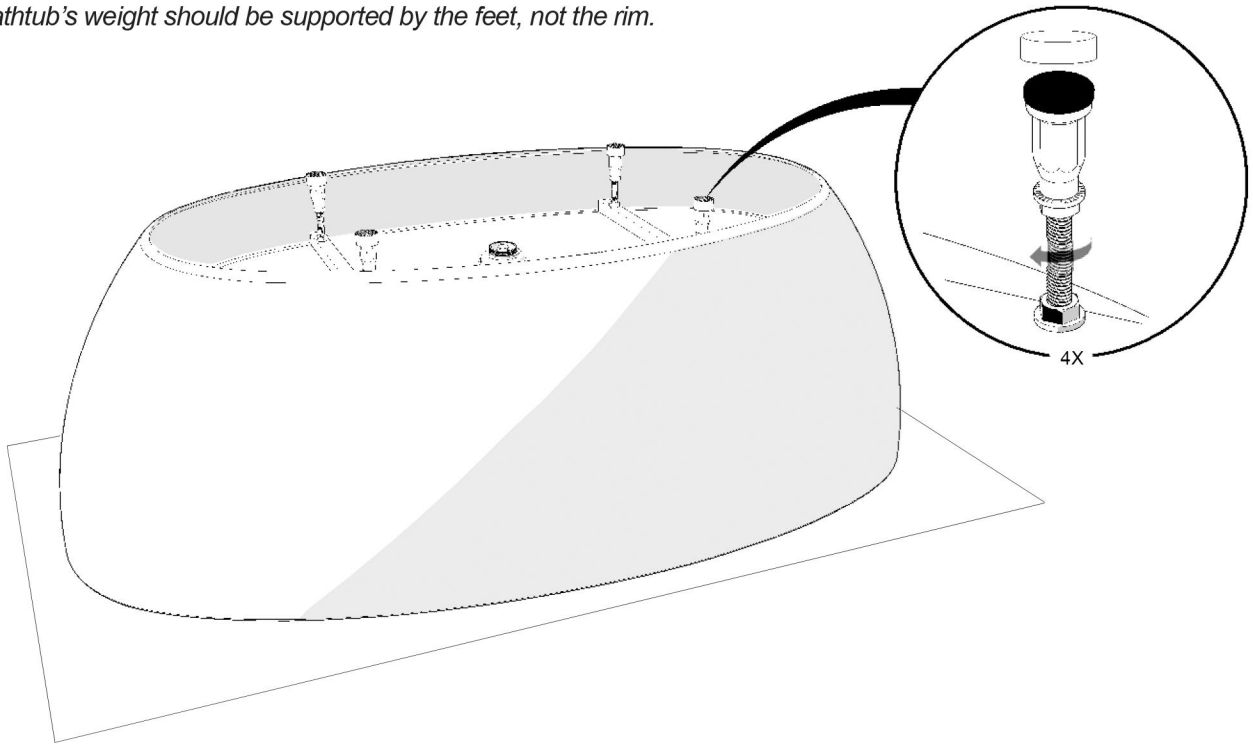

3. OBLIGATORY TEST

The bathtub must be tested before installation is completed. Fill the tub to the overflow and inspect it for leaks. Tighten any loose connections.

4. APPLY A 100% CLEAR OR WHITE SILICONE SEAL UNDERNEATH THE BATHTUB.

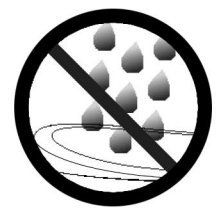
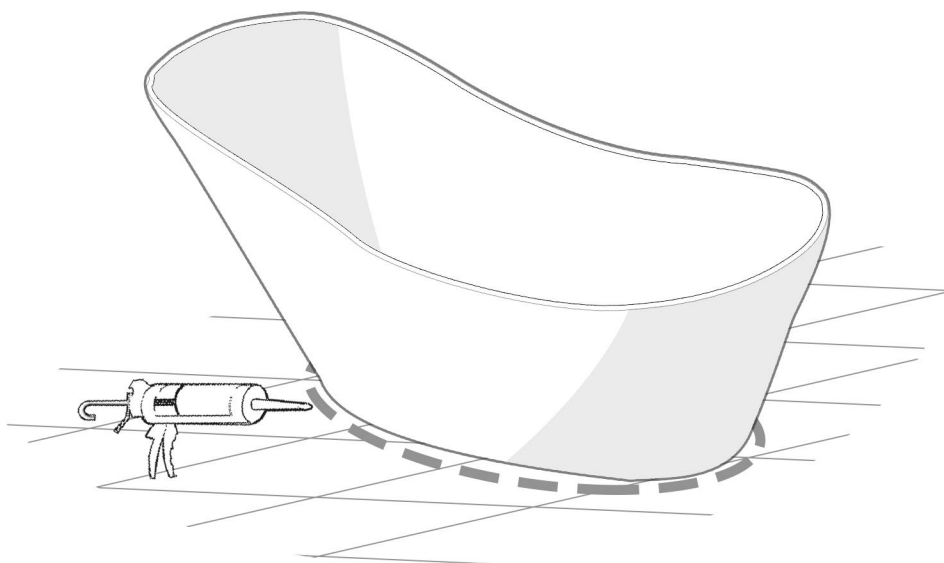

24 HOURS

TROUBLESHOOTING

Water accumulates around the drain and the bathtub does not empty completely.

- Check that the installation is level and that the bathtub sits firmly on its base.

Bottom of bathtub moves during use.

- Bathtub is not sitting firmly on its base shim if necessary.

Polyethylene film will not come off.

- Use a hair dryer to heat the adhered surface.

MAINTENANCE

Regular disinfections provide an effective defense against types of bacteria susceptible of developing over time. For general maintenance cleaning, use a moist cloth and gentle liquid detergent. For acrylic surfaces, occasional use of a special acrylic surface cleaner will add luster and protect the finish. **Do not** use abrasive cleaners, scrapers, metal brushes, or any items or products that could scratch or dull the surface. **Paint stains:** Use either turpentine or a paint thinner. **Silicone:** Use a plastic or wood spatula covered with a damp cloth only. If a rubber mat is used, it must be removed immediately after each use. Ignoring this recommendation will cause damage not covered by the Kitchen and Bath Masters warranty. Certain types of therapeutic products added to bath water, or applied non-diluted directly into the bathtub, may damage the unit's finish. **Test the product on a small inconspicuous surface prior to use.**

SAFETY

- **DANGER!** Do not permit children to use bathtubs unless they are closely supervised by an adult at all times.
- Use this bathtub only for its intended purpose as described in this manual. Do not use attachments not recommended by the manufacturer.
- Never use or handle electrical devices while in or near a filled bathtub.
- Never drop or insert any objects into any of the bathtub openings like drain or overflow.

