

WARNING

WE RECOMMEND INSTALLATION OF THIS LIGHTING FIXTURE BE DONE BY A LICENSED ELECTRICIAN.

WARNING *** SWITCH OFF THE MAIN ELECTRICAL SUPPLY FROM THE MAIN FUSE BOX/CIRCUIT BREAKER BEFORE INSTALLATION.

INSPECT ITEM CAREFULLY BEFORE ATTEMPTING TO INSTALL. IF THERE IS ANY DAMAGE OR OBVIOUS DEFECT, DO NOT INSTALL. ITEM MAY NOT BE RETURNED ONCE IT HAS BEEN INSTALLED.

CARE AND MAINTENANCE

To clean the outside of the fixture, use a dry or slightly dampened clean cloth (use clean water, never a solvent) to wipe the surface of the fixture.

To clean the inside of the fixture, first disconnect power to the fixture by turning off the circuit breaker or by removing the fuse at the fuse box. Next, use a dry or slightly dampened clean cloth (use clean water, never a solvent) to wipe the interior surface of the fixture.

Do not use any cleaners with chemical, solvents or harsh abrasives. Use only a dry soft cloth to dust or wipe carefully.

NOTICE & IMPORTANT SAFETY INSTRUCTIONS

* Please make sure that you have all parts indicated before you begin assembly of this item

* This item should be assembled on a soft surface to prevent scratching the finish during assembly

* To reduce the risk of fire, electrical shock or injury to persons or property, please follow the guideline below for safe use and installation

*The external flexible cable or cord of this lamp cannot be replaced







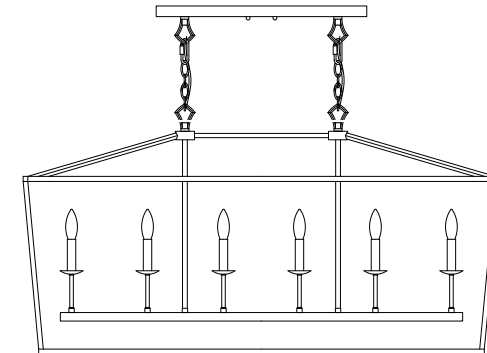







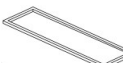

If the cord is damaged, the lamp shall be destroyed

Model#: JYL7439A/JYL7439B/JYL7439C

Product Dimensions: 49"LX15"W X 27.5"H

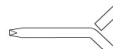

Part List and Hardware List

PIECE	DESCRIPTION	PICTURE	QUANTITY	PIECE	DESCRIPTION	PICTURE	QUANTITY
A	Conical frame		1X	J	Screwed Ball		2X
B	Frame support rod		4X	K	Chain		2X
C	Rectangular frame		1X	L	Bulb		6X
D	Flat head Phillips screw (lock on frames)		16X+4X	O	Mounting bracket		1X
E	Loop		2X	P	mounting screw		2X
F	Rubber gasket		2X	Q	canopy screw		2X
G	Hang rod		2X	S	Ground screw		1X
H	Lamp holder		1X	T	Wire connector		3X
I	Canopy		1X	U	screwdriver		1X

PREPARATION

Step 1

Unlock the flat cross screw (D) from the conical frame (A) and the rectangular frame (C) by using screwdriver

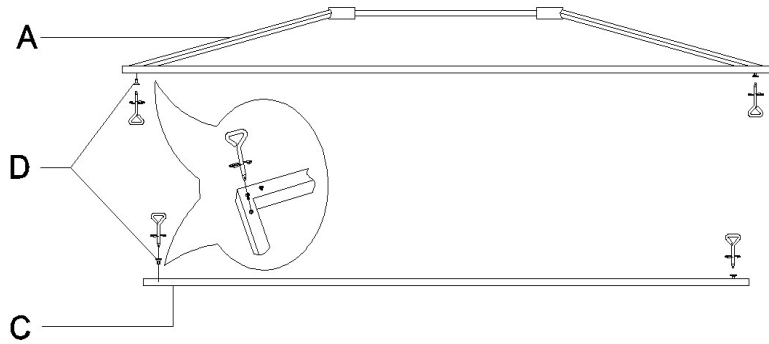

Step 2

Fixed Conical frame(A) and Rectangular frame(C) with Frame support rod (B) by Flat head Phillips screw(D)

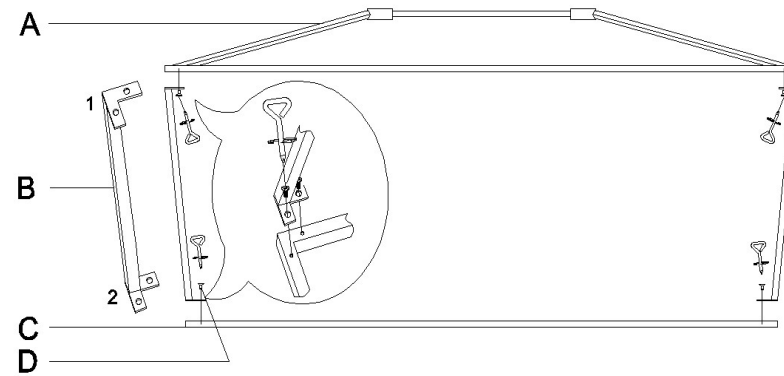

Step 3

Pass the wire through the hang rod(G), fix it on lamp holder(H) by clockwise rotation. Then continue to pass the wire through top frame, rubber gasket(F) and loop(E). Rotated loop(E) by clockwise to fix lamp holder(H) and lamp body frame.

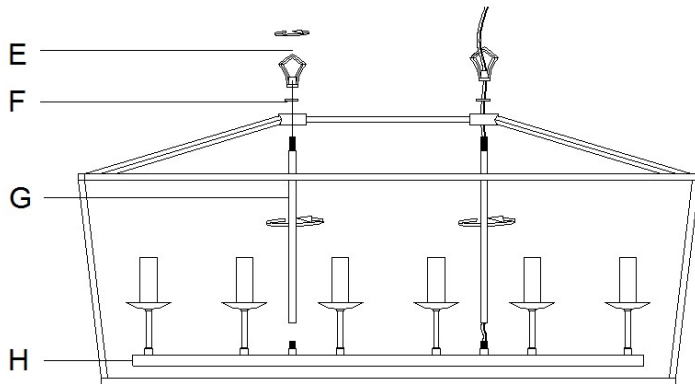

Step 4

Used Chain(K) to connect the canopy (I) with lamp body, then pass the wire through Chain(K) to canopy(I).

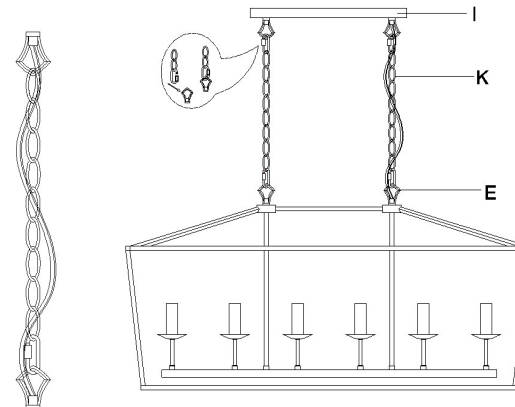

Step 5

Install the mounting bracket(Q) to the junction box with machine screw (P).

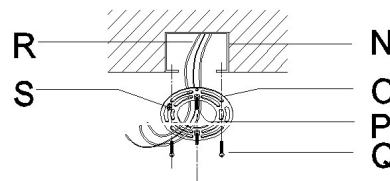

Step 6

Make wire connections, with wire connectors(T), following the reference chart listed below.

Connect,Hot,Black or Red outlet Supply Wire to:	Connect,Neutral,White Outlet Supply Wire to:
Black	White
*Parallel Cord(round&smooth)	*Parallel Cord(square&ridged)
Clear,Brown,Gold or Black without Tracer(colored stripes)	Clear,Brwn,Gold or Black without Tracer(colored stripes)
Insulated Wire(not green)with copper metal conductor	Insulated Wire(not green)with Silver metal conductor



*Note: When parallel wire(SPTI&SPTII)is used. The neutral wire is square shaped and ridged and the hot wire will be round in shape and smooth.(See illustration on l



Grounding Instructions:

- a) For installation in the United States: Wrap ground wire from outlet box around green ground screw on mounting bracket, no less than 2" from wire end. Tighten ground screw. If fixture is supplied with a ground wire, connect to outlet ground wire with a wire connector.
- b) For installation in Canada: If fixture is supplied with ground wire, wrap ground wire around green grounding screw on mounting bracket. Tighten ground screw.

Step 7

Fixed the canopy(I) with mounting bracket(O)by screwed ball(J).

Step 8

Install bulb(L). Be sure to use light bulb(s) with wattage no greater than specified on this fixture. Always make sure that electrical current is turned off before changing bulbs.

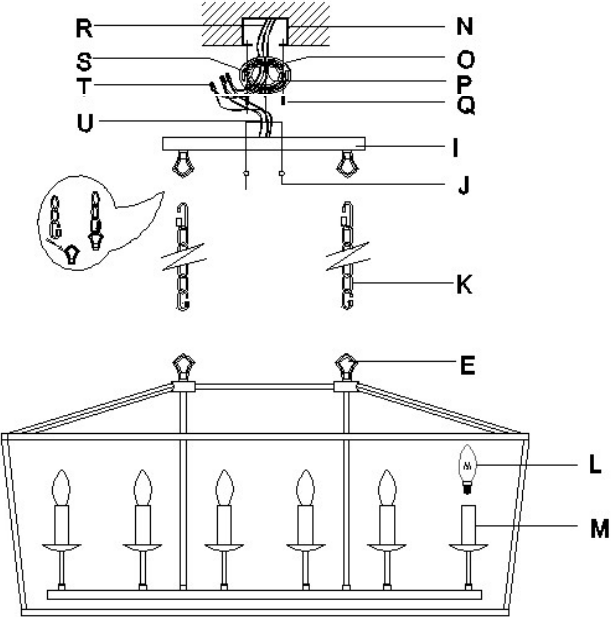

**PLEASE USE TYPE"B" BULB MAX 40-WATT OR CFL BULB MAX 13-WATT OR LED BULB MAX 9-WATT
THERE ARE 6PCS LED 4 WATT BULB IN THE BOX
ENJOY YOUR LAMP**