

Features

- 6 1/16" spout reach
- Includes metal touch-activated drain
- 1.2 gal/min (4.5 l/min) maximum flow rate [max at 60 psi (4.14 bar)]
- Coordinate with Artifacts faucets, accessories, and showering components to complete your bathroom
- Handles sold separately
- "Deck or Bath-Mount installation"
- Premium Metal Construction
- Widespread
- Includes open flume spout and metal touch-activated drain.
- Handles sold separately.
- 6-1/16-inch spout reach.
- 1.2 gpm (gallons per minute) flow rate.
- Coordinate with your choice of Artifacts handles for a personalized design.
- Premium metal construction.
- KOHLER finishes resist corrosion and tarnishing.
- Widespread
- Quick-Connect hose connections make widespread faucet installation a snap.
- This product can help a building earn Water Efficiency points in the LEED® Green Building Rating System.

Required Products/Accessories

K-98068-4 Widespread Bathroom Sink Faucet Handles

or

K-98068-3M Widespread Bathroom Sink Faucet Handles

or

K-98068-9M Widespread Bathroom Sink Faucet Handles

or

K-98068-3 Widespread Bathroom Sink Faucet Handles



Codes/Standards

ASME A112.18.1/CSA B125.1

NSF/ANSI 61

NSF/ANSI 372

All applicable US Federal and State material regulations

DOE - Energy Policy Act 1992

EPA WaterSense®







California Energy Commission (CEC)

KOHLER® Faucet Lifetime Limited Warranty

See website for detailed warranty information.

Available Colors/Finishes

Color tiles intended for reference only.

Color	Code	Description
	CP	Polished Chrome
	SN	Vibrant® Polished Nickel
	BN	Vibrant® Brushed Nickel
	BV	Vibrant® Brushed Bronze
	2BZ	Oil-Rubbed Bronze
	2MB	Vibrant Brushed Moderne Brass
	VNT	Vintage Nickel

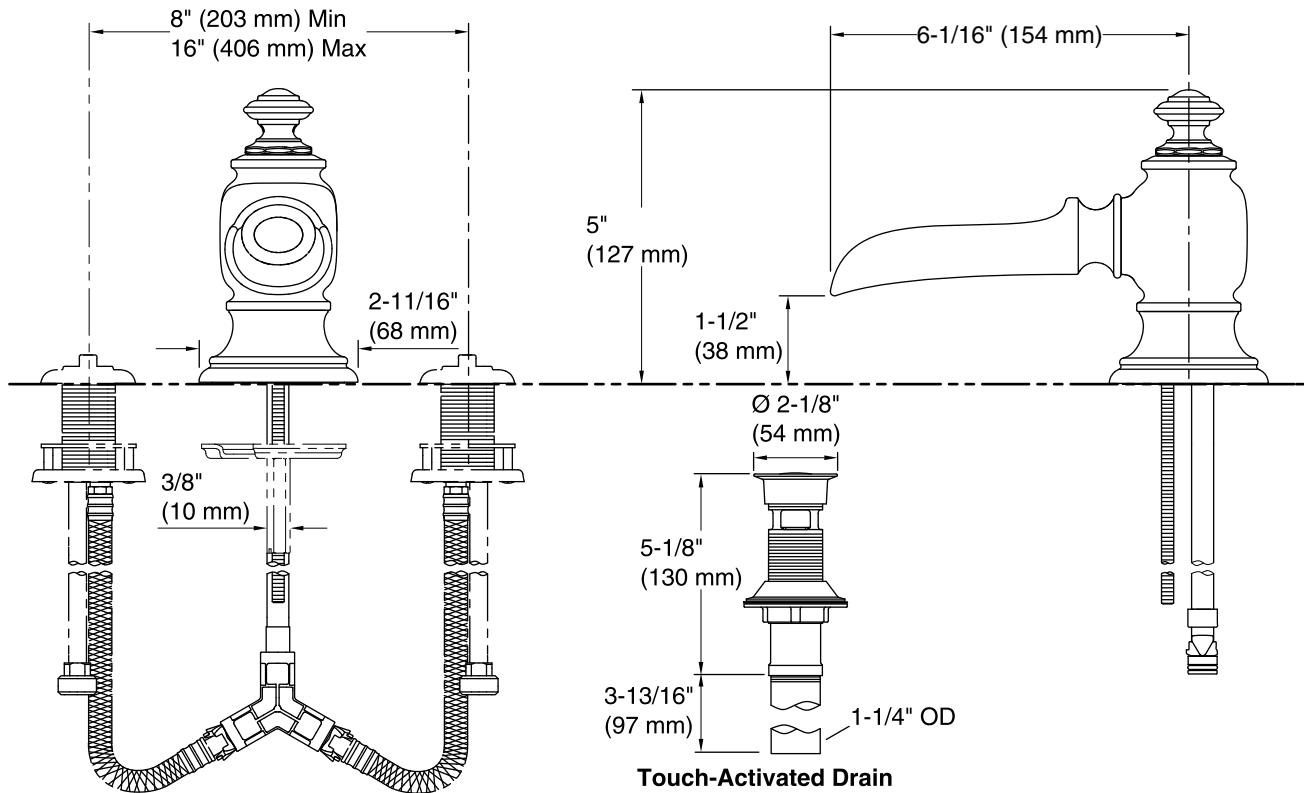

Technical Information

All product dimensions are nominal.

Faucet:

Flow rate: 1.2 gal/min (4.5 l/min)

Pressure: 60 psi (4.1 bar)

Notes

Install this product according to the installation instructions.