

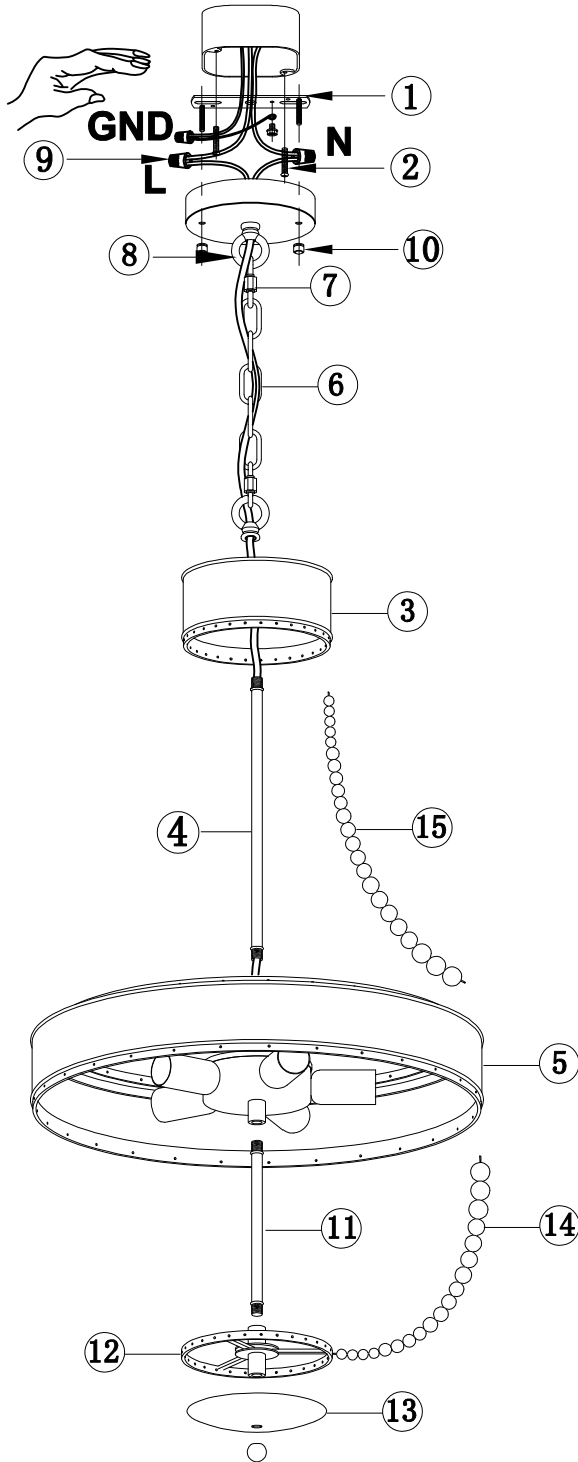

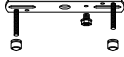







ITEM NO.: SYB5265WO-LT

FIXTURE ASSEMBLY STEPS:

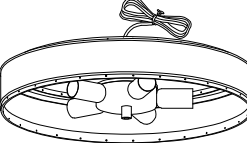

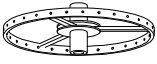
DESCRIPTION	PICTURE	CODE	QTY
Mounting Plate		1/10	1 SET
Mounting Box Screw		2	2 PCS
P3 Wiring Cap		9	3 PCS
Canopy+Loop + Safety buckle+Chain		6/7/8	1 SET
Combination circle		3	1 SET
On the pole		4	1 PCS
Combination circle		5	1 SET
Downswing		11	1 PCS
Circle		12	1 PCS
Bottom bracket		13	1 PCS
Wooden beads		14	31PCS
Wooden beads		15	31PCS

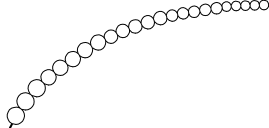
WARNING - if any Special Control Devices are used with this Fixture, Follow the instructions Carefully to assure full compliance With N. E. C. requirements. if there are any questions, contact a Qualified Electrical Contractor.
CAUTION - All glass is fragile, use care when handling Glass component(s) and or Lamp(s).
WARNING - This product contains chemicals known to the State of California to cause cancer, birth defects and/or other reproductive harm. Thoroughly wash hands after installing, handling, cleaning, or otherwise touching this product

CANOPY MOUNTING & WIRE CONNECTION ASSEMBLY STEPS:

Attach (N), (P) to achieve overall desired length.
 Una (N), (P) para lograr la longitud deseada.
 Joignez (N), (P) pour obtenir la Longueur voulue.

FIXTURE ASSEMBLY STEPS:

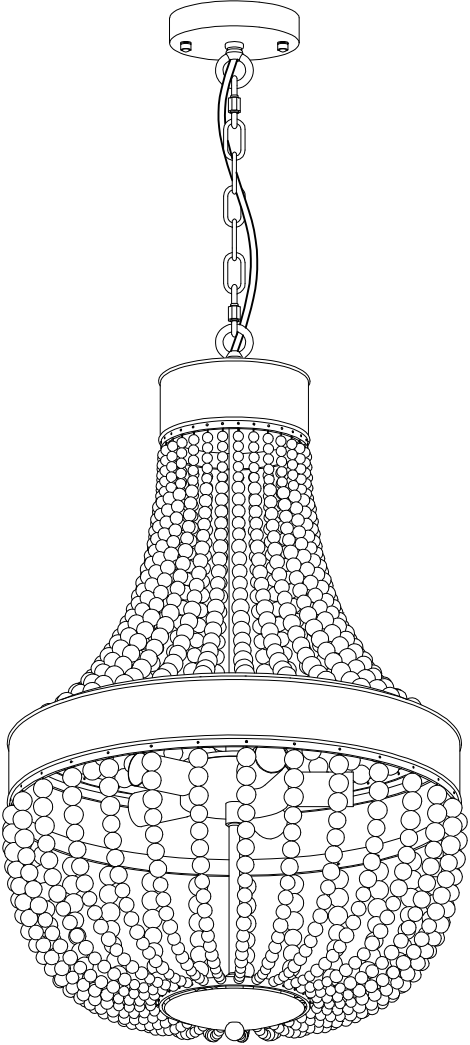
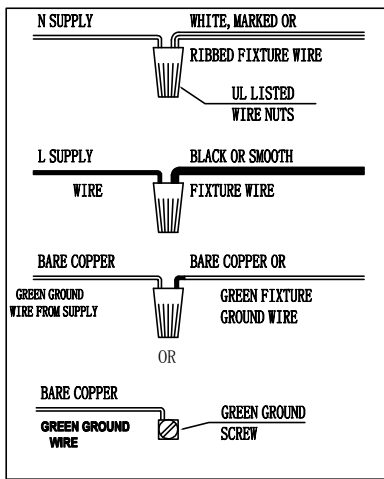

110-120V / 60Hz
 E12 5*MAX 60W TYPE B
 (Do not contain light bulb)

ITEM NO. : SYB5265W0-LT

1. AC110~120V, 50~60Hz. The Max lamps power is 60W TYPE B Bulb.
2. Avoid to scratch the surface of lighting and the wires when install it.
3. Connect the neutral wire with the N wire, the live wire with the L wire, the earth one with the earth symbol (L-L, N-N).
4. Don't install it to the ceiling before it's completely dry, the surrounding around must be ventilated and dry.
5. Keep away from the acid, basicity objects and gases, clean with soft cloth, water washing is not allowed.
6. The lighting must be installed by professional electrician and used indoor only.
7. Please keep attention to cut off the power supply when installing, cleaning, and replacing bulb.