

### Features

- Rectangular basin with curved bottom.
- Overflow drain.
- No faucet holes; requires wall- or counter-mount faucet.
- 52047 clamp assembly

### Material

- Vitreous china.

### Installation

- Under-mount

### Recommended Products/Accessories

K-8998 P-Trap

### Included Components

Additional Components:

1193643 Basin Clamps



ADA

### Codes/Standards

ASME A112.19.2/CSA B45.1

ADA











ICC/ANSI A117.1

### KOHLER® One-Year Limited Warranty

See website for detailed warranty information.

### Available Colors/Finishes

*Color tiles intended for reference only.*

Color	Code	Description
	0	White
	96	Biscuit
	47	Almond
	NY	Dune
	95	Ice™ Grey
	G9	Sandbar
	33	Mexican Sand™
	K4	Cashmere
	58	Thunder™ Grey
	7	Black Black™
	97	Timberline™

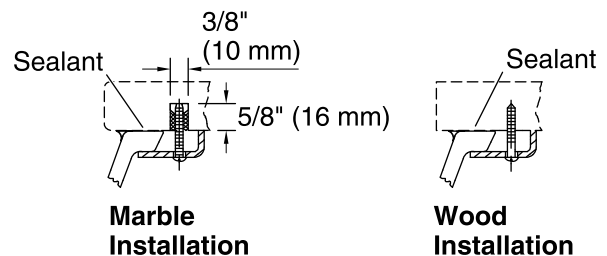
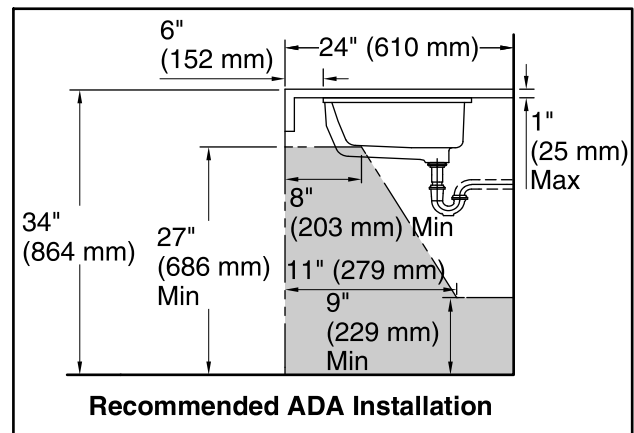
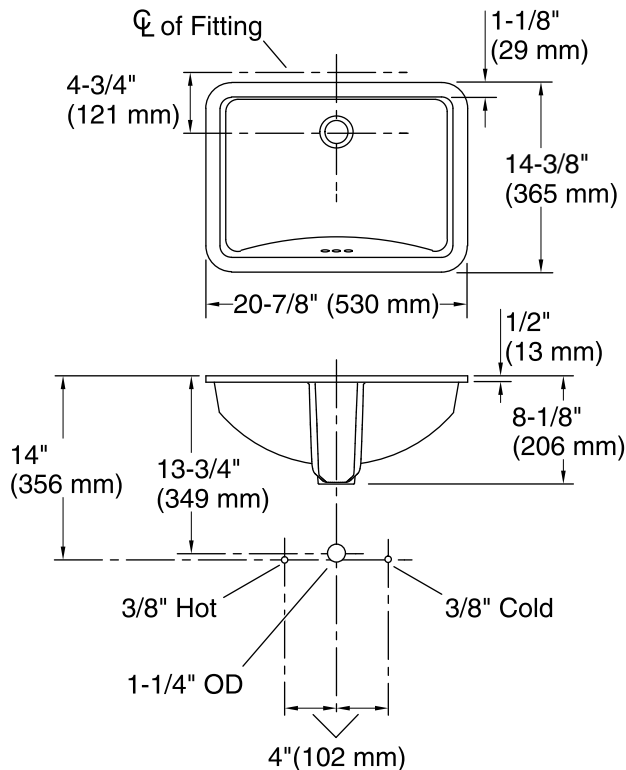

## Technical Information

All product dimensions are nominal.

Installation:	Under-mount
Bowl area:	Length: 18-5/8" (473 mm) Width: 12-1/4" (311 mm) Water depth: 4-5/8" (117 mm)
Drain hole:	1-3/4" (44 mm)
Template:	1053195-7, required, not included

## Notes

Install this product according to the installation instructions.

The product diagram is based on the K-8998 adjustable P-trap with 1" (25 mm) of tailpiece exposed.

**NOTICE:** Countertop manufacturer or cutter must use the current product template available at [www.kohler.com](http://www.kohler.com), or by calling 1-800-4KOHLER. Kohler Co. is not responsible for cutout errors when the incorrect cutout template is used.

ADA compliant when installed to the specific requirements of these regulations.