

Mina 36 Cabinet Installation Instruction

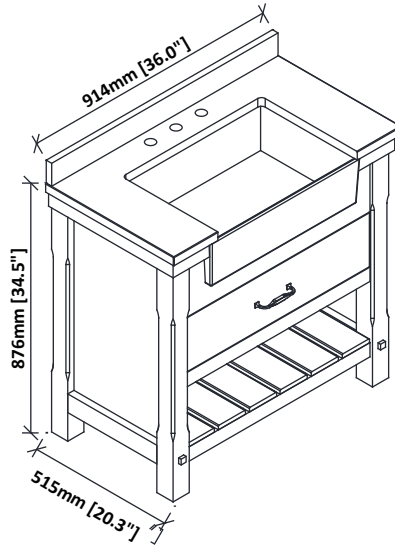

DIMENSIONS

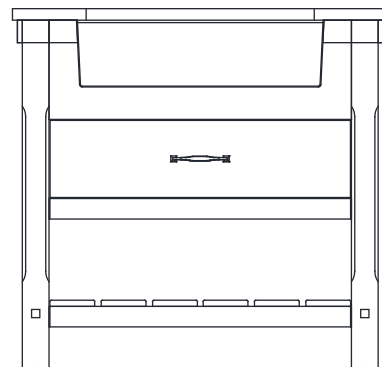
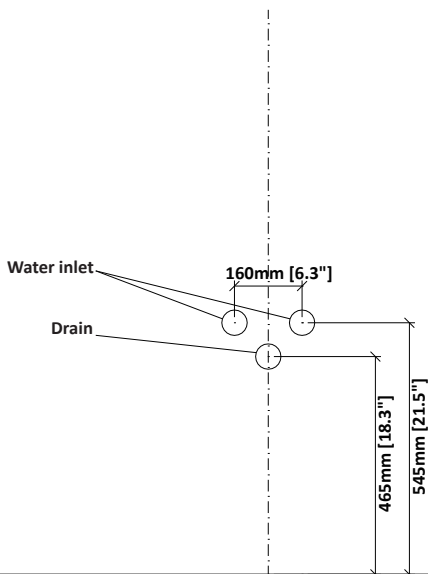
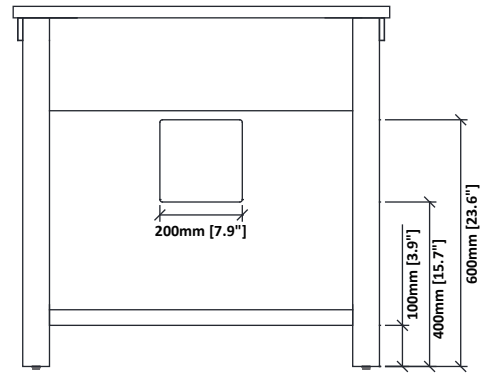
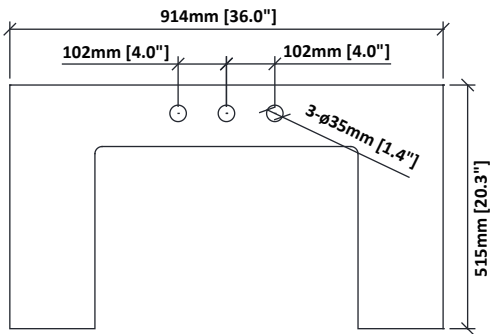

WARNING !

In the hole on the wall, please be sure to be careful to avoid the internal cables and pipelines.

MATERIALS & TOOLS

Safety glasses, Pencil, Level, Tape measure, Stud Finder, Assorted screwdrivers, Assorted Wrenches, Drill, Screw gun, Caulking gun, Hammer, Screws, Nail anchors/Molly screws.