

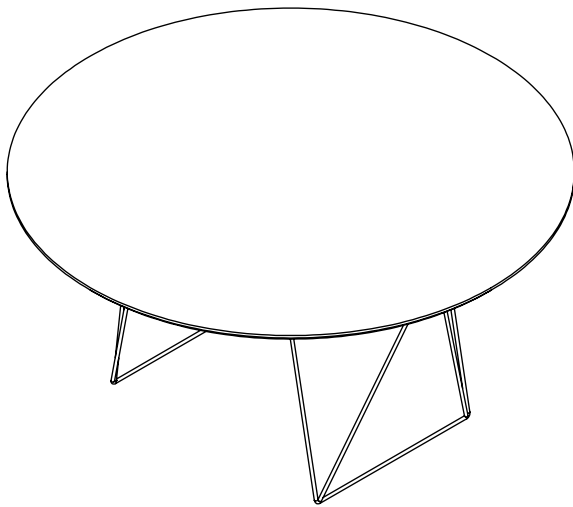

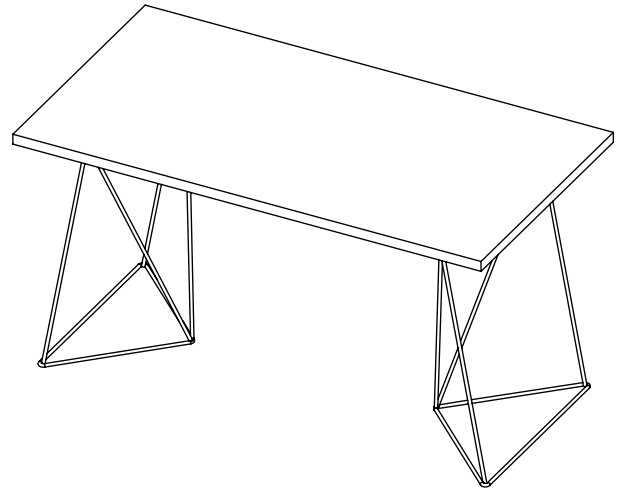

TRESTLES

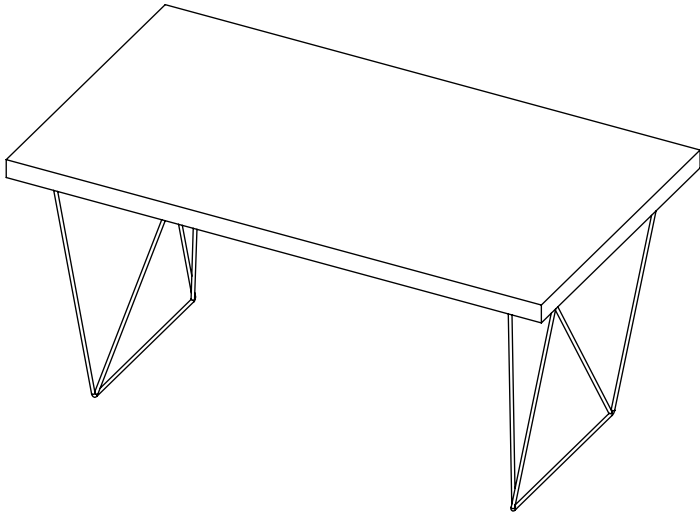
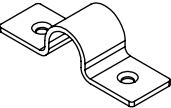

TEMAHOME

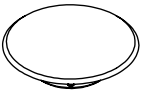
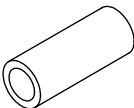
7200.280/714

A - 6x	B - 12x	C - 4x	D - 12x	E - 12x
				
0519.006	0512.031	0520.155	0520.070	0512.150



20min



max.
25kg

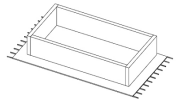
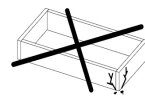

Protected wood species are not used in this product





Do not drag this product with weight on it.

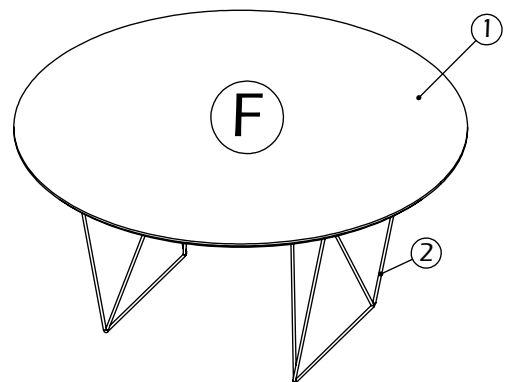
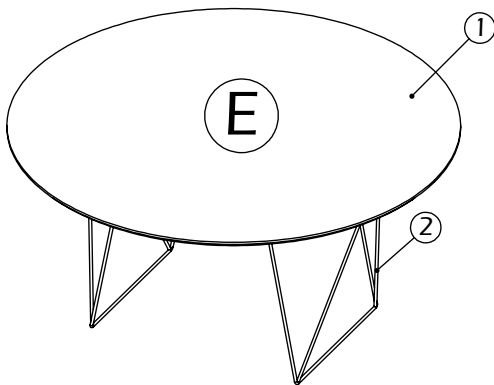
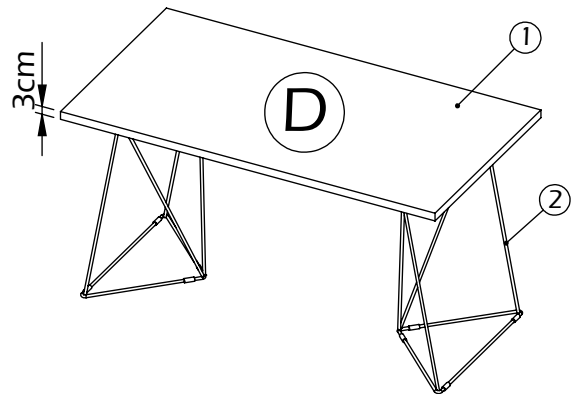
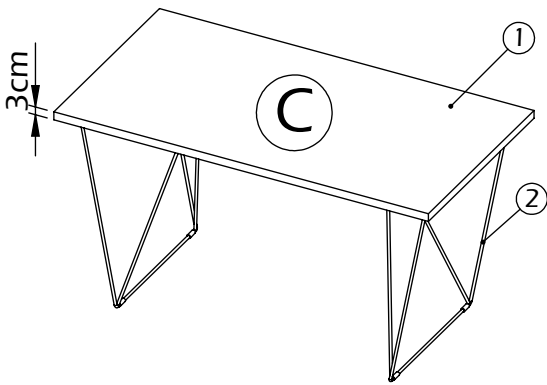
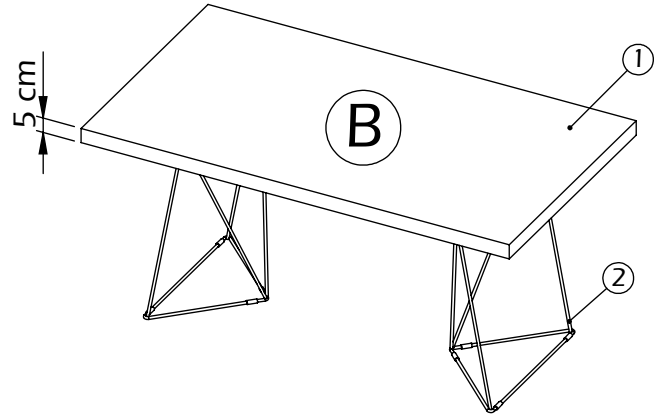
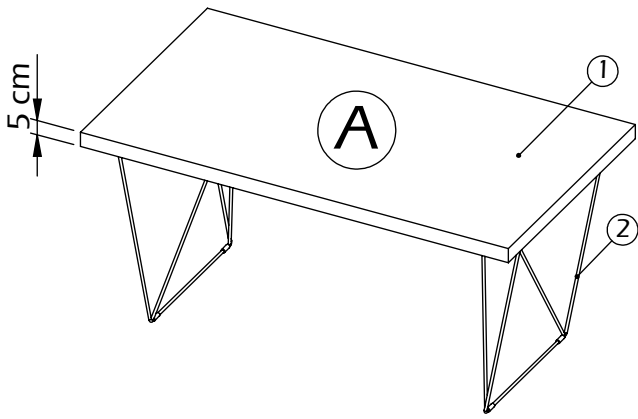

Product contains recycled wood



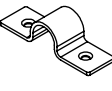

A

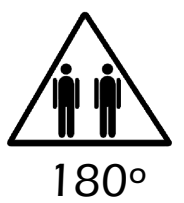
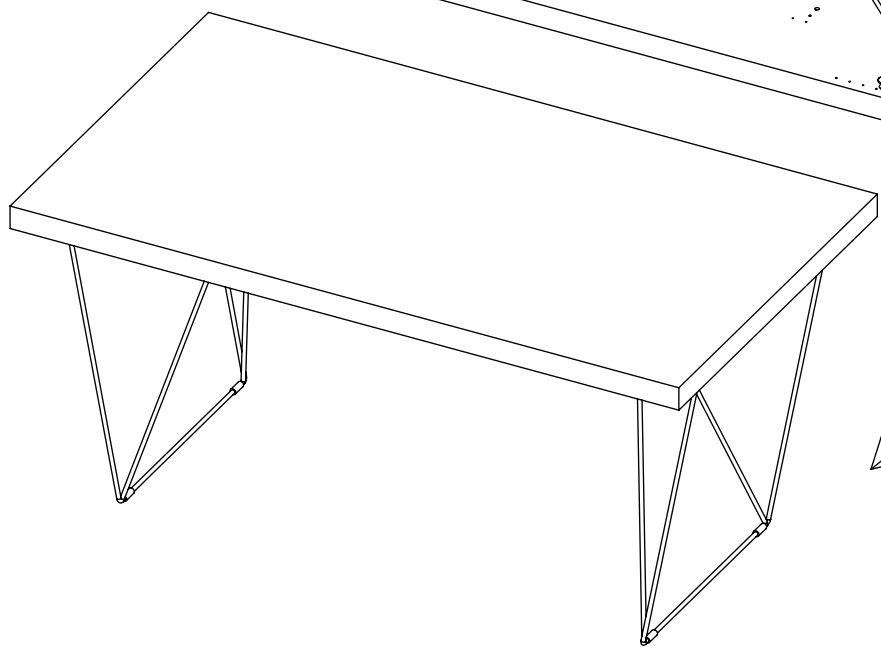
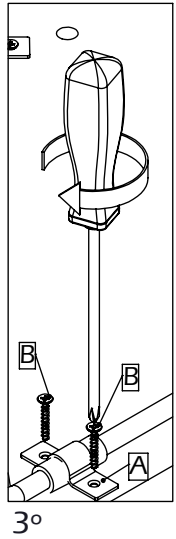
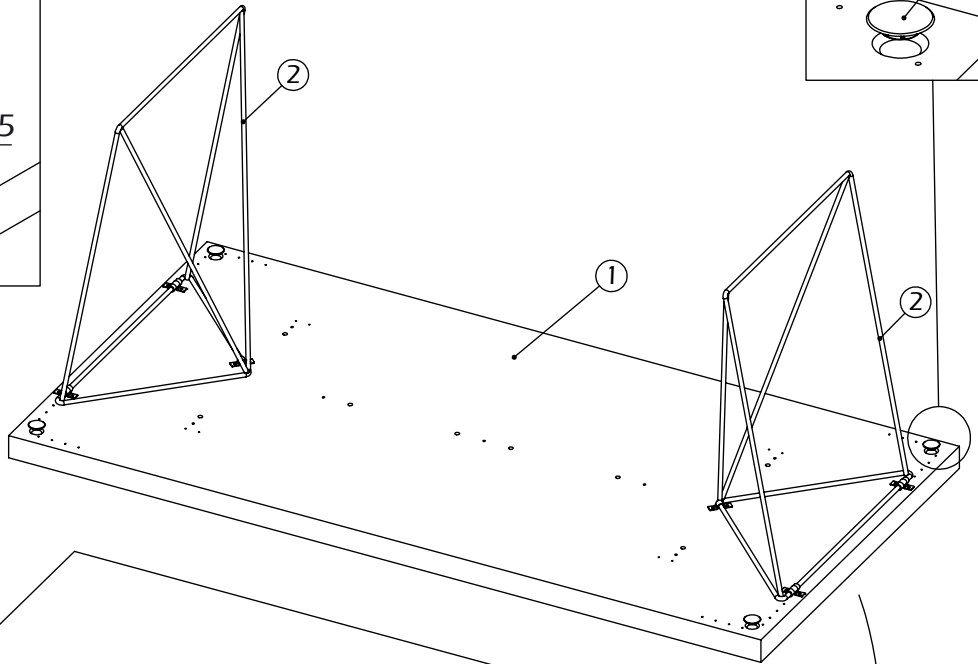
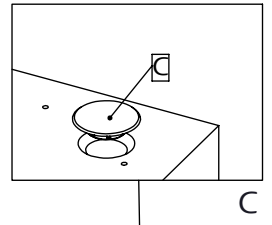
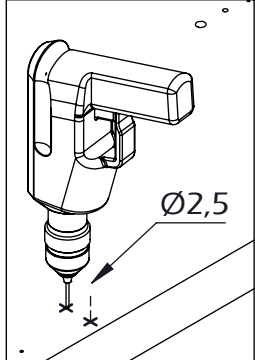
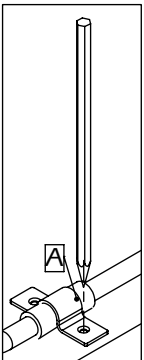
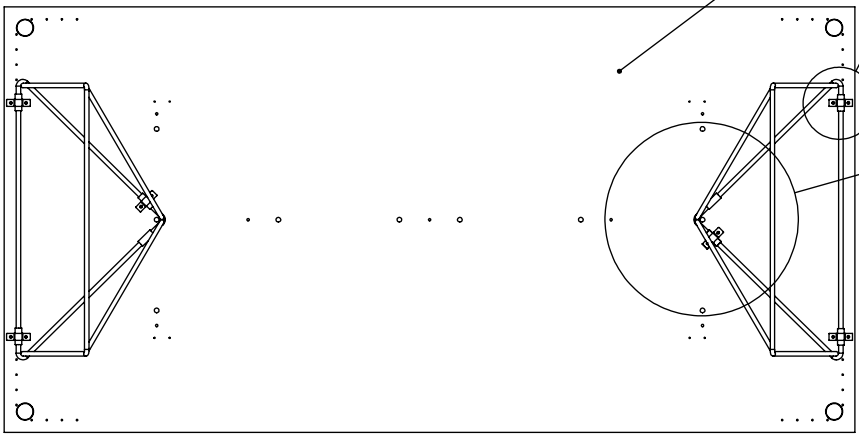
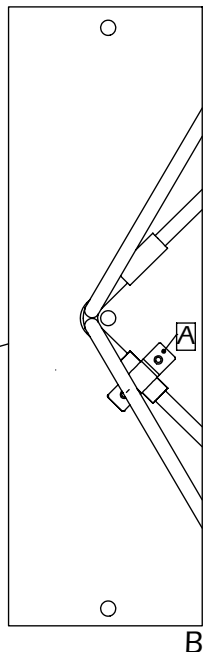
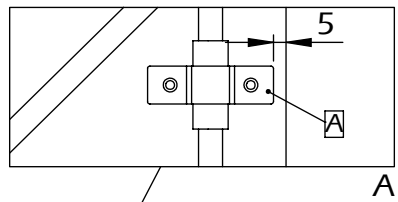
<p>x6</p> 	<p>x12</p> 	<p>x8</p> 
<p>A - 50x15x2 B - Ø3.5x25 C - Ø36x08</p>		



B

x4	x8	x4
		
A - 50x15x2	B - Ø3.5x25	C - Ø36x08

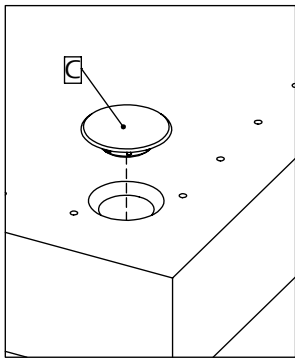
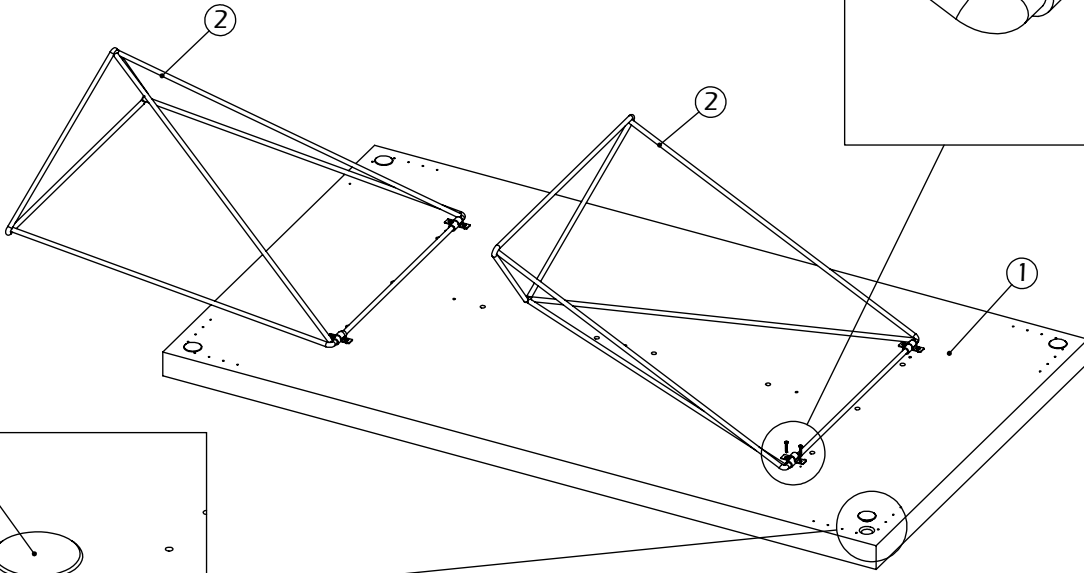
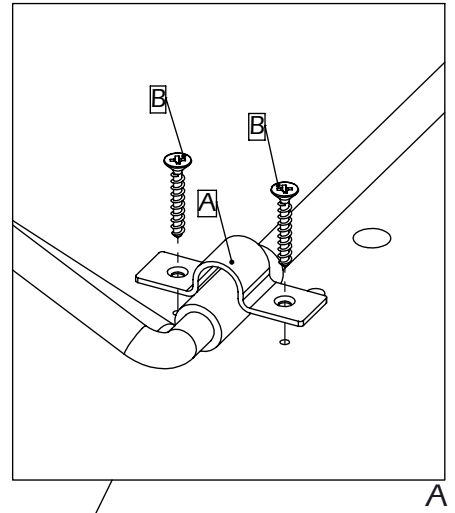

B

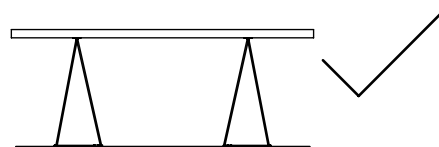
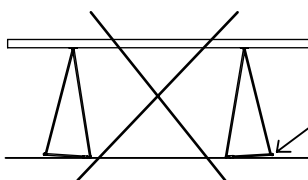
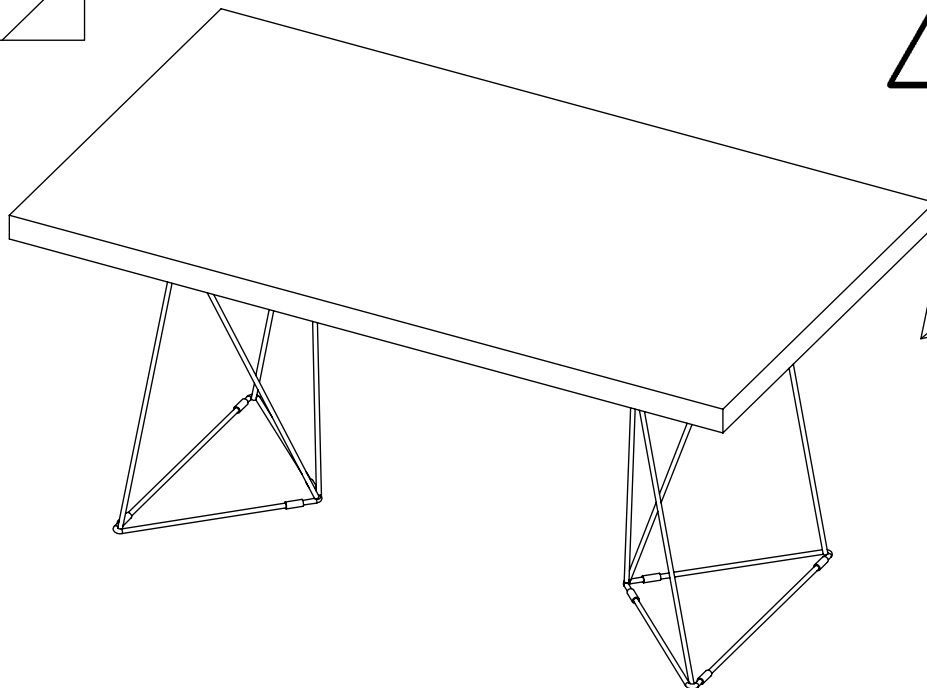
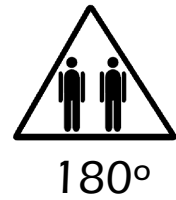

C

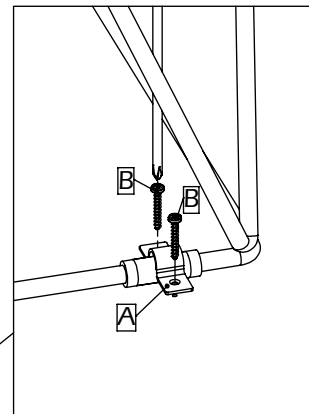
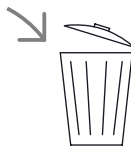
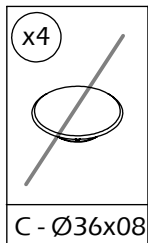
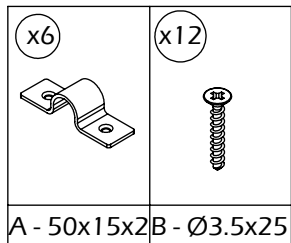

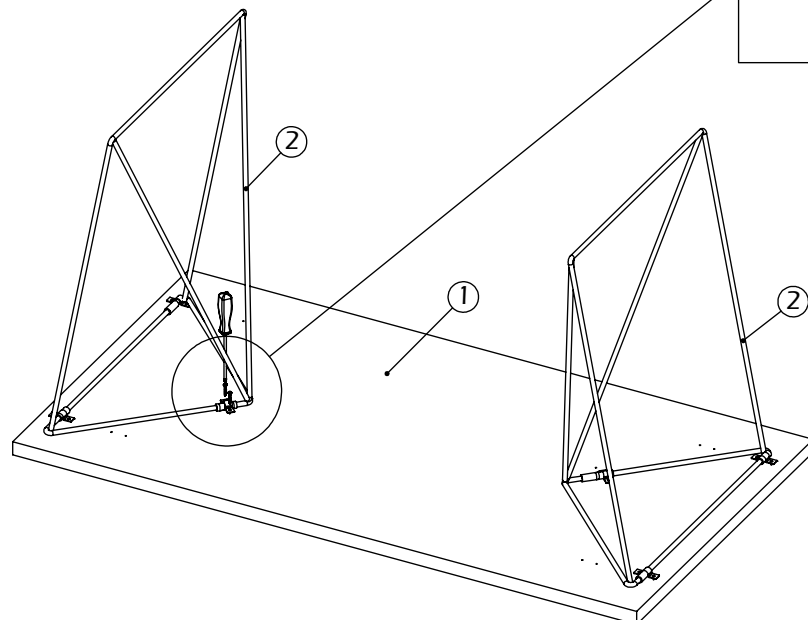

A



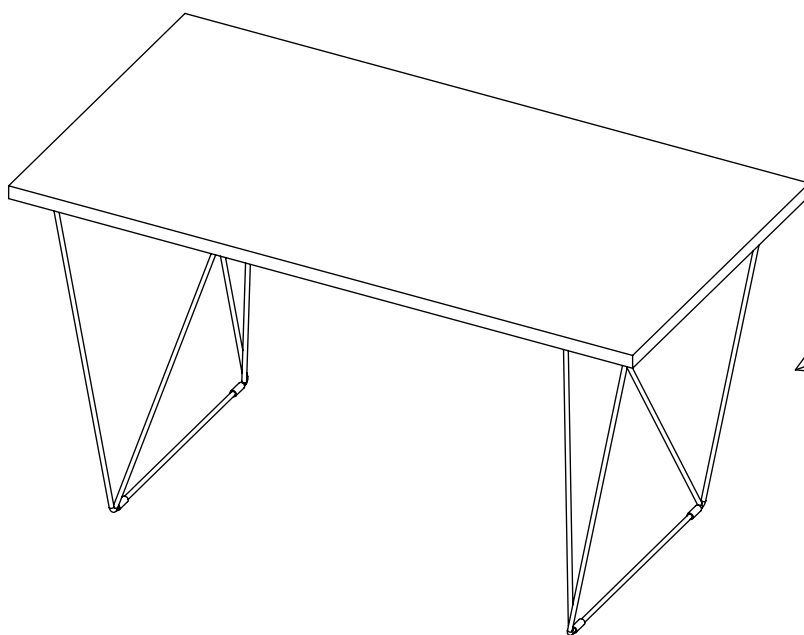

180°

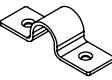

D

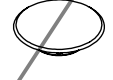
x4 	x8 
A - 50x15x2	B - Ø3.5x25

x4 
C - Ø36x08



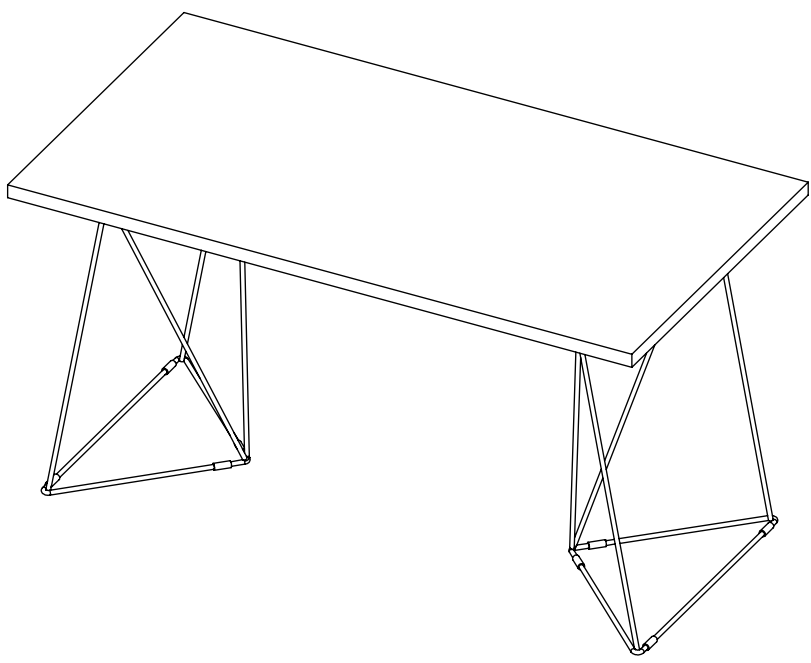
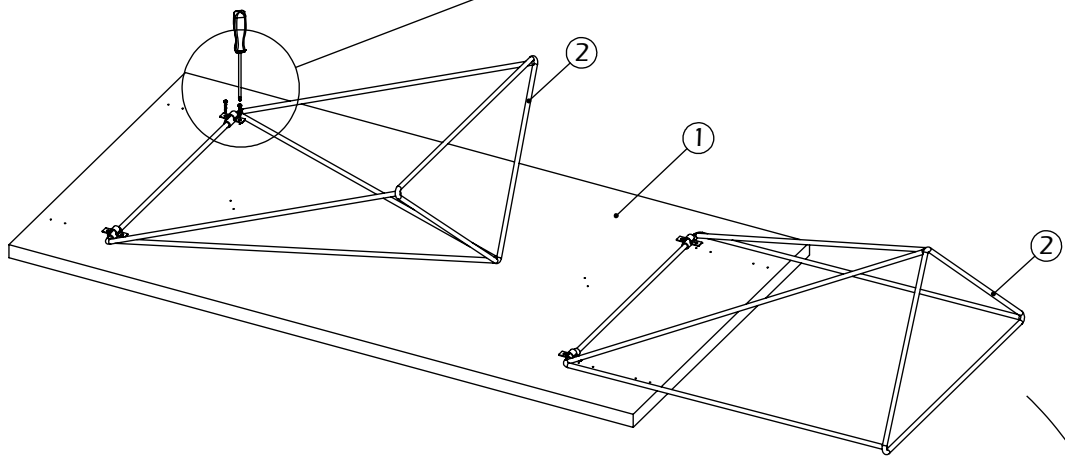
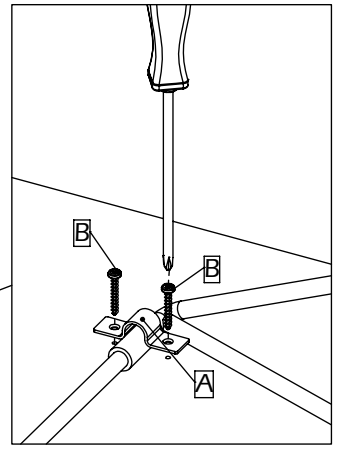



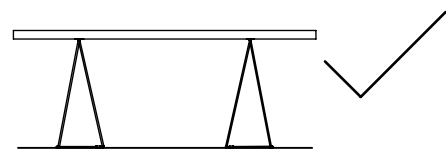
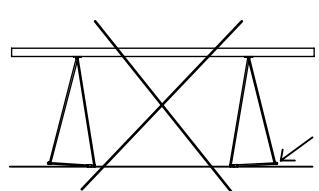

180°

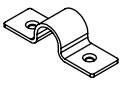
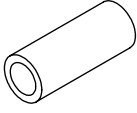

E

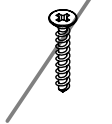
x6 	x12 	x12 
A - 50x15x2	D - Ø14x35	E - Ø4x12

x12 	x4 
B - Ø3.5x25	C - Ø36x08

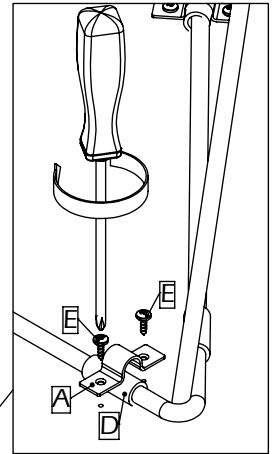
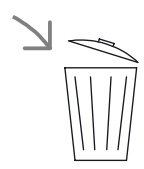

A

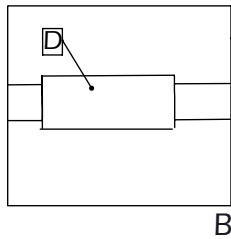
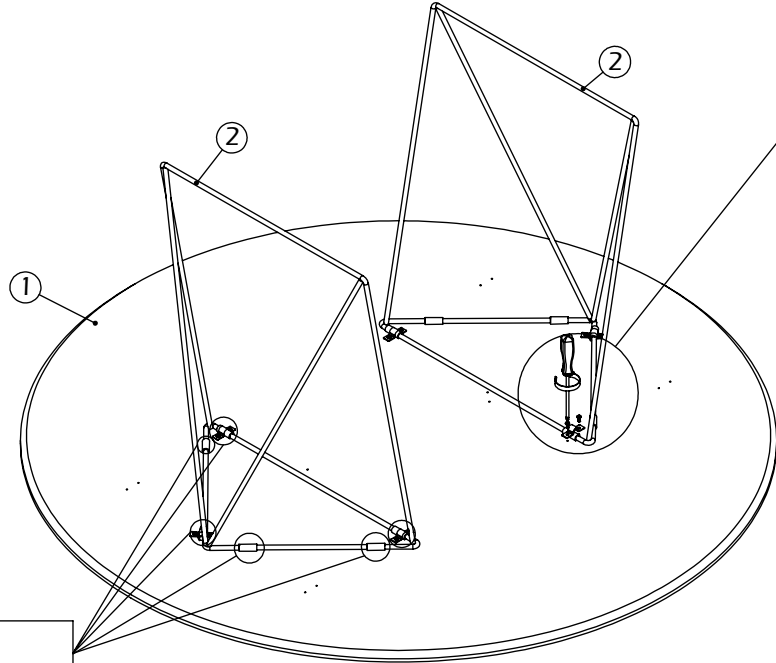





B



180°

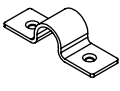
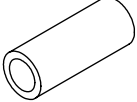

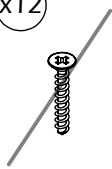
F

x6 	x12 	x12 	x12 	x4 
A - 50x15x2	D - Ø14x35	E - Ø4x12	B - Ø3.5x25	C - Ø36x08

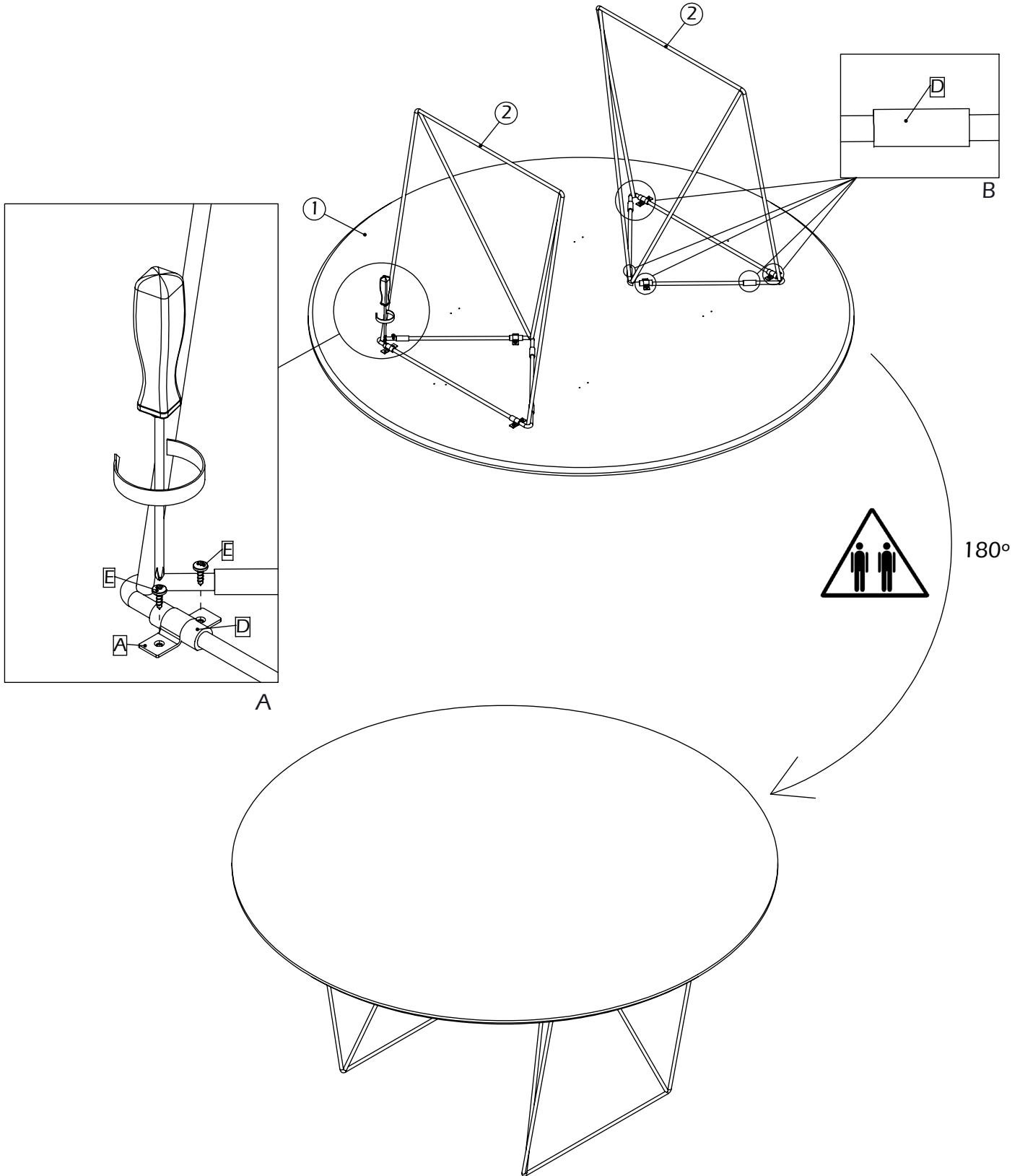
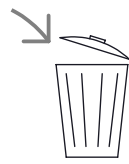

MANUTENÇÃO E CUIDADOS DE PRODUTO

PRODUCT CARE INFORMATION

CUIDADOS ESPECÍFICOS DE PRODUCTOS

HINWEISE ZUR PRODUKTPFLEGE

INFORMATION SUR L'ENTRETIEN DES PRODUITS

PORTUGUÊS

CUIDADOS A TER COM A MONTAGEM DOS PRODUTOS

A consulta das instruções de montagem é imprescindível para uma correcta instalação do mobiliário.

A superfície onde é executada a montagem deve estar isenta de partículas de madeira, bem como de poeiras e sujidades.

Colocar o cartão da embalagem entre a superfície e os elementos a montar. Evitar abrir o saco de ferragens junto da superfície onde se realizará a montagem. Siga as instruções de montagem. Regule a intensidade da aparafusadora de modo a evitar quebra (danificar) das ferragens.

Quando tiver alguma dificuldade na instalação do mobiliário peça o apoio do departamento de assistência técnica.

CUIDADOS GERAIS A TER COM OS PRODUTOS

NÃO COLOCAR OBJECTOS QUENTES NA SUPERFÍCIE DURANTE LONGOS PERÍODOS DE TEMPO

NÃO UTILIZAR LIXÍVIA DE CLORO

CUIDADOS ESPECÍFICOS A TER COM OS PRODUTOS

REVESTIMENTO COM MADEIRA NATURAL

As diferenças de tom e estrutura do veio são características próprias do folheado de madeira natural.

A madeira é um produto natural, pelo que sofre alterações provocadas pelo meio ambiente. A acção da luz solar em especial dos raios ultravioleta acelera o escurecimento da madeira (oxidação). Numa primeira fase é aconselhável que os objectos colocados sobre os móveis sejam frequentemente mudados de posição para que a madeira escureça de forma uniforme e sem manchas.

Para limpar utilize um pano seco. Em caso de derramamento de líquidos sobre a superfície, utilize um pano seco e limpo de imediato para remover excessos de água ou humidade (de forma prevenir danos no seu móvel, passe um pano seco).

O contacto com líquidos por um longo período de tempo pode danificar o produto e provocar a abertura de fissuras na superfície.

SUPERFÍCIE LACADA/ METAL LACADO

Limpar a superfície com água para remover partículas de poeiras e outros materiais abrasivos.

Para remover manchas difíceis, passe um pano macio embebido em solução de água morna e sabão suave.

Retirar todos os resíduos, resultantes da operação anterior com água limpa.

Secar a superfície com uma pano macio e seco.

Não utilizar produtos solventes, pois estes amolecem a superfície do lacado e podem danificar.

Evite a utilização de produtos de limpeza de vidros, de produtos abrasivos, bem como utensílios de limpeza rígidos. Certifique-se de que os utensílios de limpeza, não contêm areias ou outro tipo de partículas (corpos estranhos).

ENGLISH

PRODUCT ASSEMBLY CARE

Always assemble products on a clean surface, free of dirt or wood particles.

Place the package cardboard between the surface and the product components.

Open fittings bag but do not place them on the assembly surface to avoid scratches.

Follow assembly instructions carefully.

When using an electric drill or screwdriver, regulate the intensity (strength) applied in order to avoid breakage or damage of fittings and components.

If you have difficulties with the assembly, please request technical assistance.

PRODUCT CARE - GENERAL INFORMATION

DO NOT PLACE HOT OBJECTS ON SURFACE FOR LONG PERIODS OF TIME

DO NOT USE CHLORINE BLEACH.

PRODUCT CARE - SPECIFIC INFORMATION WOODEN FINISHES

NATURAL WOOD VENEER

The color and grain differences are characteristic of natural wood.

As it is exposed to sunlight, wood darkens as a result of oxidation. In order to ensure that the Product darkens uniformly, we recommend that objects placed on the surface be moved frequently during the first few months.

Clean with a dry or slightly damp cloth. In order to prevent cracking or degradation, use a clean dry cloth to wipe off any excess humidity. Normal resistance is a few minutes but if water is left on the furniture for a long period of time it will result in the absorption and expansion of the chipboard.

HIGH GLOSS SURFACE / LACQUERED METAL

Clean surface with clean water to remove dust and dirt particles.

To remove more difficult stains, use a dampened soft cloth with either soapy luke warm water.

Rinse surface with clean water and dry it with a soft dry cloth.

Do not use abrasive solvents as these may soften the surface of the lacquer and damage it.

Avoid using window cleaner.

Avoid abrasive products as well as sharp/hard cleaning utensils.

Certify that cleaning cloths are free of dirt/sand particles that may scratch surface.

ESPAÑOL

CUIDADOS DURANTE EL MONTAJE DE LOS PRODUCTOS

La superficie de montaje debe estar limpia sin partículas de madera u otras.

Colocar el cartón del embalaje entre el suelo y los elementos a montar.

Abrir la bolsa de herrajes fuera del área de montaje para evitar posibles arañazos.

Siga las instrucciones de montaje.

Regule la intensidad de la atornilladora para evitar daños en los tornillos o piezas.

En el caso de que tenga dificultades al proceder al montaje, solicite nuestro apoyo técnico.

CUIDADOS GENERICOS DE PRODUCTOS

NO DEJE OBJETOS CALIENTES EN LA SUPERFICIE NO USAR LEJÍAS

CUIDADOS ESPECÍFICOS DE PRODUCTOS

LAS CHAPAS NATURALES DE MADERA

Las diferencias de color y estructura constituyen características propias de las chapas de madera. Con la acción de la luz, las chapas de madera intensifican su color con rapidez en las primeras semanas de exposición.

Durante una primera fase, el mueble debe poder oscurecer en la totalidad de la superficie expuesta (no dejar ningún tipo de objetos en una misma zona durante un tiempo prolongado).

Para limpiar su nueva mesa y prevenir posibles daños, utilice un paño seco. En caso de excesos de agua o humedad, absorber con un paño seco. La resistencia normal es de algunos minutos, pero si el contacto es mas prolongado ocurrirá una absorción y expansión del aglomerado.

LACADOS / METAL LACADO

Limpiar la superficie con agua limpia para quitar las partículas de polvo y otros materiales abrasivos.

Quitar manchas difíciles de limpiar usando un paño suave y agua templada con jabón neutro.

Para la limpieza final usar agua limpia para eliminar cualquier residuo que podría haber permanecido en la superficie.

Evite el uso de productos disolventes, puesto que éstos ablandan las superficies lacadas y pueden causar daños.

Evite el uso de productos de limpieza como limpia cristales.

Evite el uso de productos y utensílios de limpieza abrasivos.

Asegúrese que los utensílios de limpieza son libres de polvo, arena o cualquier otra partícula abrasiva.

DEUTSCH

HINWEISE ZUR MONTAGE DES PRODUKTS

Bitte montieren Sie das Produkt immer auf einer sauberen, schmutzfreien und von schädlichen Stoffen befreiten Oberfläche.

Um Kratzer zu vermeiden, schützen Sie die Oberfläche

durch entsprechende Auflagen (z.B. Karton).

Öffnen Sie den Beschlagsbeutel nicht auf der ungeschützten Oberfläche. Befolgen Sie die Montageanleitungen Schritt für Schritt. Bei Verwendung einer Bohrmaschine achten Sie bitte auf die Drehzahlstärke, um Beschädigungen der Beschläge zu vermeiden. Wenn Sie Schwierigkeiten bei der Montage haben, können Sie sich gerne mit unserem Kundendienst in Verbindung setzen.

ALLGEMEINE PFLEGEHINWEISE ZU DEN PRODUKTEN

KEINE HEI Ë OBJEKTE AUF DER OBERFLÄCHE FÜR LÄNGERE ZEIT LEGEN

KEINE BLEICHMITTEL VERWENDEN

PFLEGEHINWEISE ZU DEN PRODUKTEN PRODUKTPFLEGE

ECHT HOLZ FURNIER

Farb- und Strukturunterschiede sind bei Echtholz-Furnier naturbedingte Eigenschaften. Durch die Sonneneinstrahlung gewinnt das Kirschbaumholz an Schönheit und Dunkelheit in der ersten Zeit relativ stark nach.

Das Möbel muss daher in dieser ersten Zeit ganzflächig nachdunkeln können (bitte keine Gegenstände, wie Vasen, etc. über längere Zeit am gleichen Standort stehen lassen).

Zur Pflege von Holzoberflächen reicht in der Regel ein Staubtuch aus. Die Flächen sind regelmässig abzustauben oder nebelfeucht abzuwischen.

PFLEGEANLEITUNG FÜR HOCHGLANZ-MÖBEL

Oberfläche mit sauberem Wasser reinigen, um Staub und Schmutz-Partikel zu entfernen.

Um hartnäckige Flecken zu entfernen, verwenden Sie bitte ein weiches Stofftuch und warmes Wasser mit etwas Spülmittel darin. Nach Reinigung mit klarem Wasser nachwischen und gut trockenreiben. Falls nötig, Oberfläche mit einem Staubtuch nachpolieren.

Bitte keinesfalls Politurmittel verwenden, da diese die Oberfläche des Lacks weichmachen und beschädigen können. Vermeiden Sie Fensterreinigungsmittel. Bitte keine Bürsten oder ähnliche abschleifende Reinigungswerkzeuge verwenden.

Bitte immer sicherstellen, dass Sie weiche Reinigungslappen verwenden, die frei von Schmutzpartikeln sind.

FRANÇAIS

PRÉCAUTIONS LORS DU MONTAGE

La surface de montage doit être dégagée et propre, sans particules de bois ou autres poussières.

Placez le carton entre le sol et les produits à monter.

Ouvrez le sac de quincaillerie mais ne le laissez pas sur la surface de montage pour éviter de possibles rayures. Suivez attentivement les instructions de montage.

Lors de l'utilisation d'une visseuse, réglez l'intensité de façon à éviter tous dommages (quincaillerie ou pièces). En cas de difficultés, veuillez solliciter notre assistance technique.

PRÉCAUTIONS GÉNÉRALES

NE LAISSEZ PAS D'OBJECTS CHAUDS SUR LA SURFACE

NE PAS UTILISER D'EAU DE JAVEL

PRÉCAUTIONS SPÉCIFIQUES

PLACAGE EN BOIS NATUREL

Les différences de teinte et de structure constituent des caractéristiques liées à la matière même du placage en bois naturel. Sous l'influence de la lumière solaire, le placage gagne en beauté et fonce assez fortement au cours de la période initiale d'exposition. Dans les premiers temps, le meuble doit donc pouvoir foncer sur l'intégralité de la surface exposée (n'y déposez aucun objet tel que vases, etc. à même endroit pendant une durée prolongée).

NETTOYE LA SURFACE AVEC UN TISSU SEC

Pour le nettoyage de votre table, utilisez un chiffon sec et propre afin d'éviter tout excès d'humidité.

FINITION EN HAUTE BRILLANCE / MÉTAL LAQUÉ

Le processus normal de nettoyage :

Nettoyez la surface avec de l'eau propre pour enlever les particules de poussière et autres matières abrasives. Pour les taches rebelles, utilisez un chiffon doux et de l'eau tiède avec du savon doux.

Utilisez de l'eau propre pour enlever tout résidu qui pourrait être resté sur la surface.

Nettoyez la surface avec un chiffon sec et doux.

Ne pas utiliser de produits solvants car ceux-ci adoucissent les surfaces laquées et peuvent provoquer des dommages.

Évitez l'utilisation de produits pour les surfaces en verre.

Évitez l'utilisation de produits et d'ustensiles de nettoyage abrasifs.

Assurez-vous que les ustensiles utilisés ne contiennent pas de poussière, sable ou autres particules abrasives.