

SPEAKMAN® S-1183

Transfer Valve

FEATURES:

- Zinc Handle
- ½-14 NPT Threaded Inlet & Two Outlet Connections
- Brass Valve Body
- Ceramic Cartridge
- Mounting Plate & Hardware included

FINISH:



PC BN

COMPLIANCE:

- ASME A112.18.1/CSA B125.1 certified

WARRANTY:

- 1 year limited



DIMENSIONS:

NOTE: 1. All dimensions are in inches (millimeters) unless otherwise specified and are subject to change without notice.

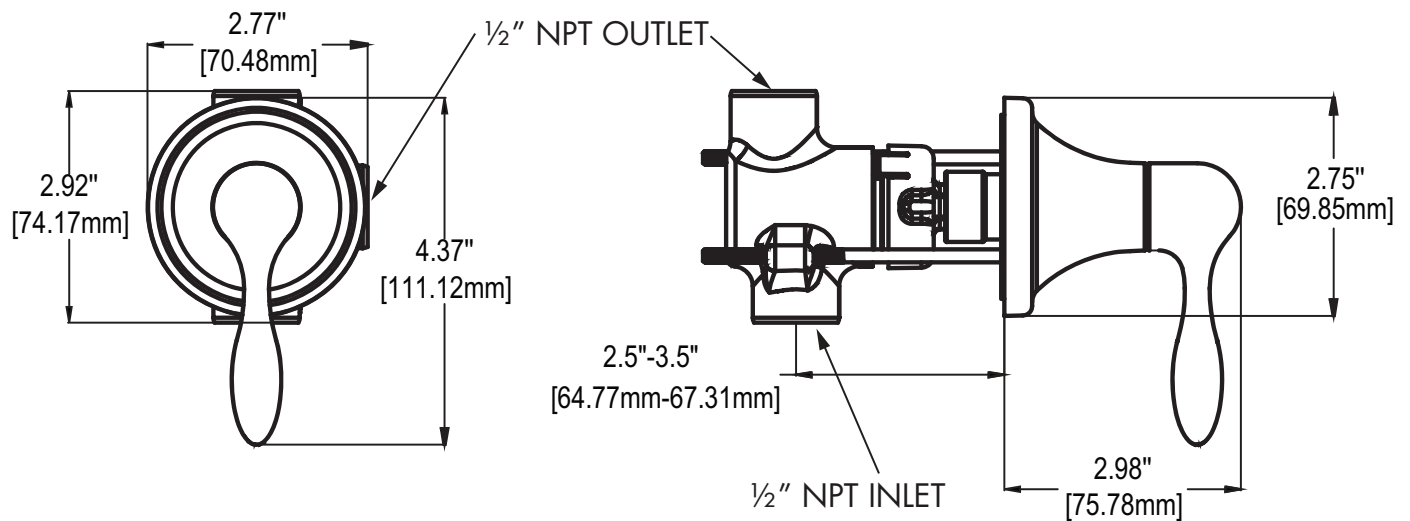

Architect/Engineer Approval Space:

SPEAKMAN
400 ANCHOR MILL ROAD
NEW CASTLE, DE 19720

P: 800-537-2107
F: 800-977-2747
W: WWW.SPEAKMAN.COM
R: AUGUST 2016