

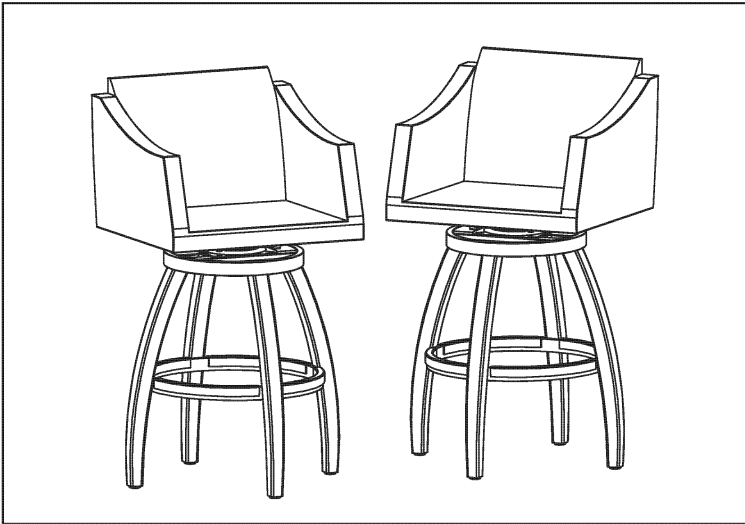







Swivel Barstool Set of 2

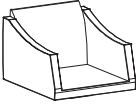

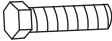
Assembly Instructions

**IMPORTANT, RETAIN FOR FUTURE REFERENCE.
READ CAREFULLY.**

Parts List

NO.	PICTURE	PART DESCRIPTION	QTY
A		Chair Seat	1
B		Chair Base	1
C		Bolt (M8x30)	4
D		Washer	4
E		Spring Washer	4
F		Nut	4
G		Nut Cap	4
H		Hex Wrench	2

Step 1.

BASE ASSEMBLY - Placing the chair seat (A) upside down, secure the base (B) using the nut cap, nut, spring washer, washer and bolt. Secure using the wrench (provided).

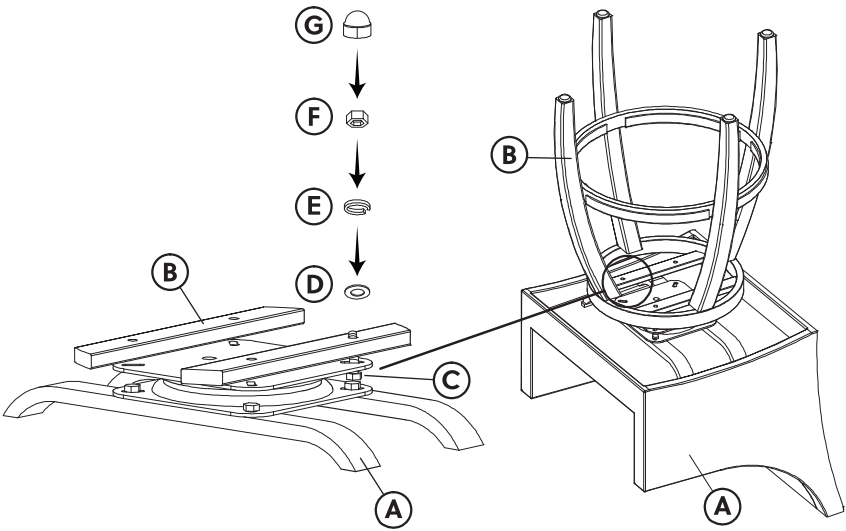

Step 2.

CHAIR ASSEMBLY - Upright the chair, tightening in any areas as needed.



Care & Maintenance

All outdoor furniture is subject to UV rays and weather elements. In order to keep your furniture as long lasting and vibrant as possible, simply rinse and use a mild soap to clean the frame. We advise using furniture covers or storing the furniture when not in use. Refer to the stain chart for fabric care.



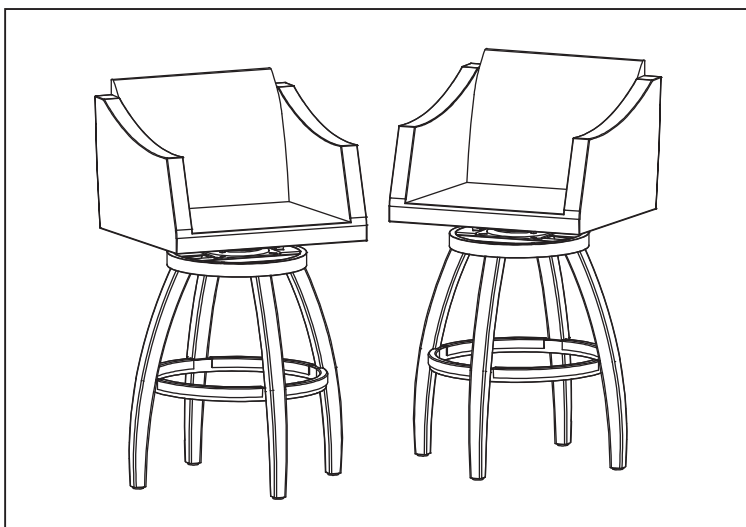





Tabouret de bar pivotant

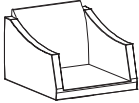

Instruction D'assemblage

**IMPORTANT, À CONSERVER À TITRE DE RÉFÉRENCE.
À LIRE ATTENTIVEMENT.**

Liste Des Pièces

NO.	IMAGE	RÉFÉRENCE DESCRIPTION	QTE.
A		Siège	1
B		Base	1
C		Boulon (M8x30)	4
D		Rondelle	4
E		Rondelle élastique	4
F		Écrou	4
G		Capuchon d'écrou	4
H		Clé hexagonale	2

Étape 1.

ASSEMBLAGE DE LA BASE - Placez la chaise (A) à l'envers, fixez la base (B) au moyen du capuchon d'écrou, de l'écrou, de la rondelle élastique, de la rondelle et du boulon. Serrez avec la clé (fournie).

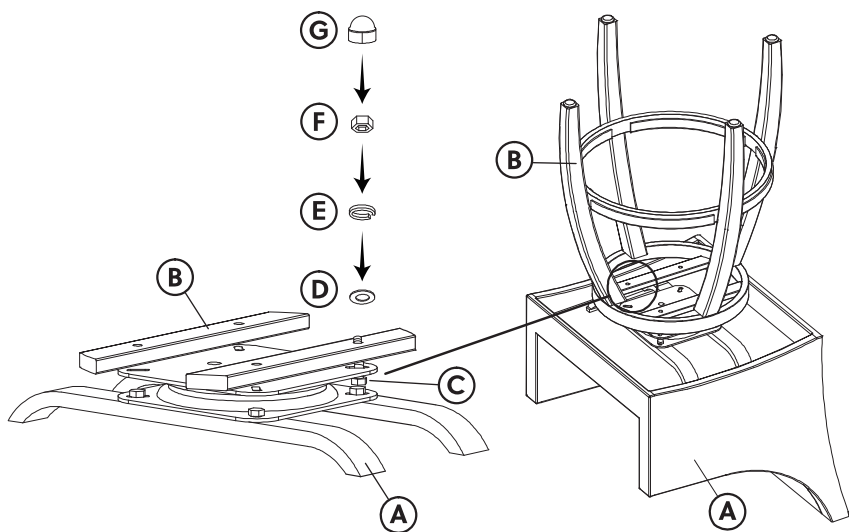

Étape 2.

ASSEMBLAGE DE LA CHAISE - Mettez la chaise à la verticale, en serrant les éléments nécessaires.

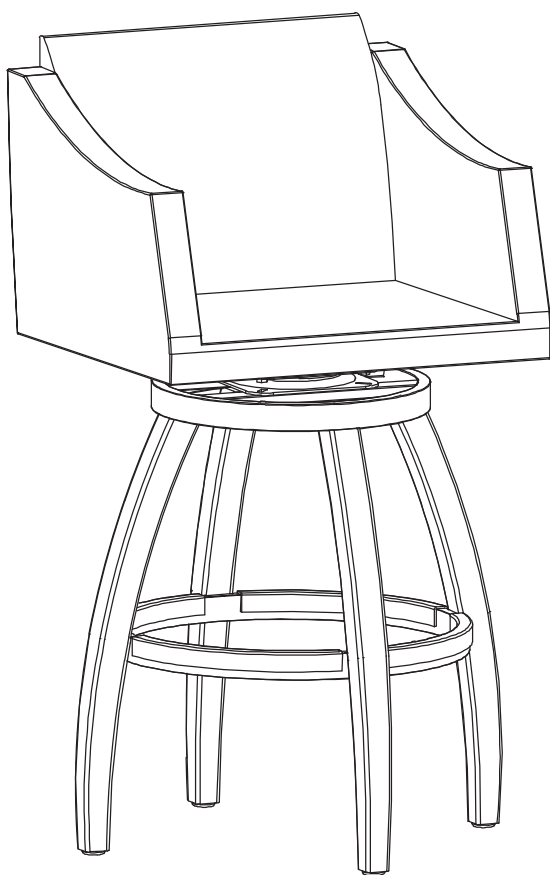

Entretien Et Maintenance

Tous les meubles d'extérieur sont soumis aux rayons UV et aux intempéries. Afin que vos meubles durent aussi longtemps que possible et que leur couleur reste vibrante, simplement rincer et nettoyer le cadre avec un savon doux. Lorsqu'ils ne sont pas en cours d'utilisation, Il est conseillé de recouvrir les meubles de housses ou de les entreposer. Consulter les directives d'entretien des tissus figurant dans le diagramme des taches.



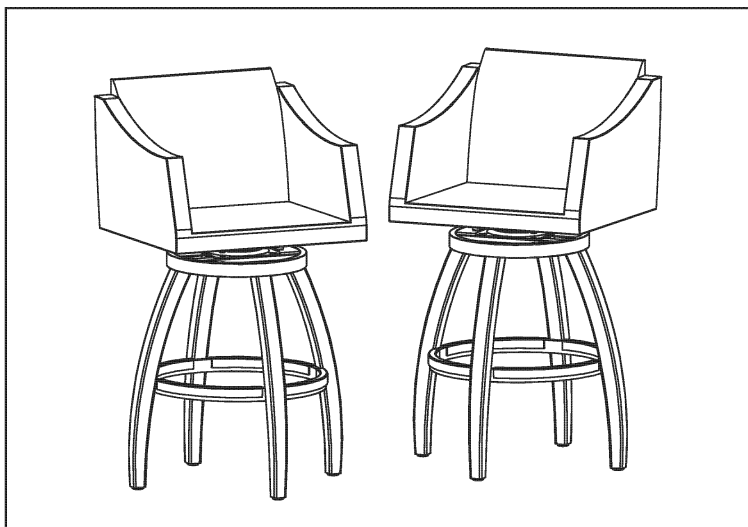



Banqueta giratoria

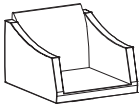

Manual de Instrucciones y Ensamble

**IMPORTANTE, RETENER PARA FUTURAS CONSULTAS.
LEA CUIDADOSAMENTE.**

Lista de Partes

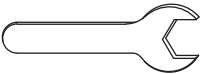
NO.	IMAGE	DESCRIPTCIÓN (PARTE)	CANT.
A		Asiento de la silla	1
B		Base	1
C		Perno (M8 x 30)	4
D		Arandela	4
E		Arandela de resorte	4
F		Tuerca	4
G		Tapa de la tuerca	4
H		Llave hexagonal	2

Paso 1.

ENSAMBLAJE DE LA BASE - Colocando el asiento de la silla (A) boca abajo, asegure la base (B) con la tuerca, la tapa de la tuerca, arandela, arandela de resorte y perno. Asegure utilizando la llave (incluida).

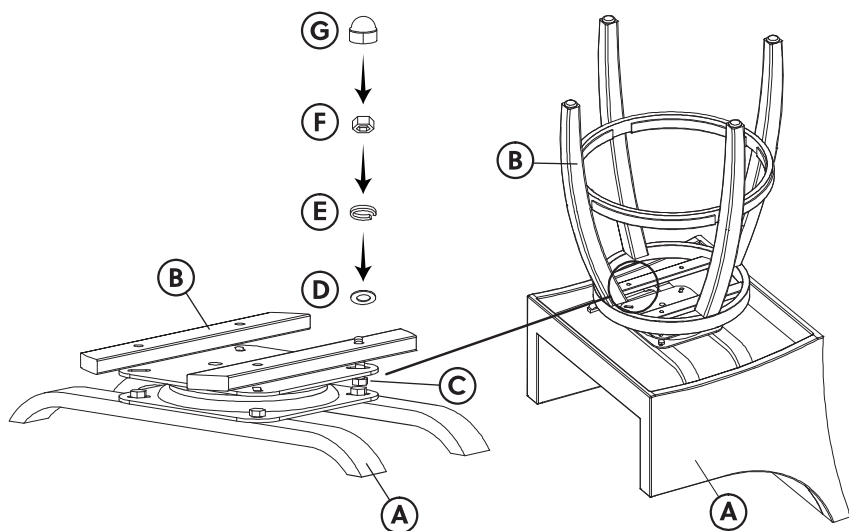

Paso 2.

ENSAMBLAJE DE LA SILLA - Coloque la silla en posición vertical y ajuste en cualquier área, como sea necesario.

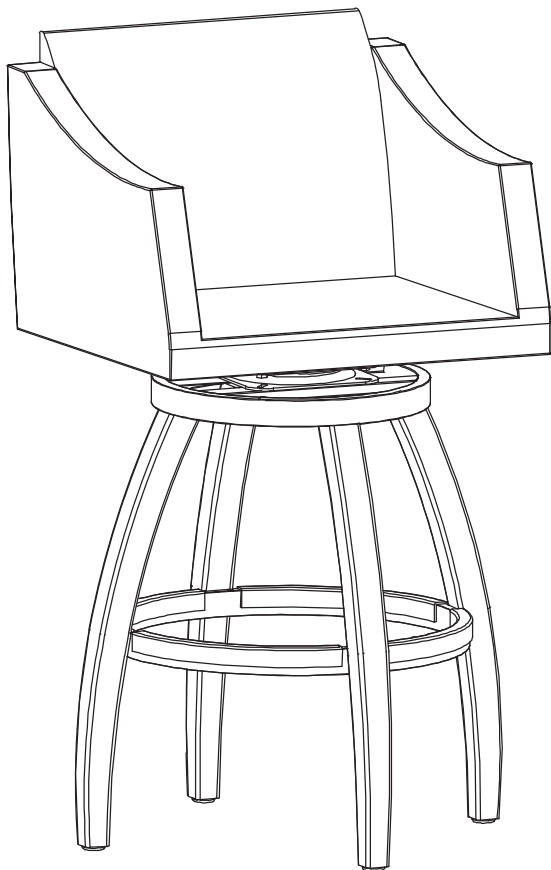

Cuidados Generales

Todo los muebles al aire libre está sujeta a los rayos UV y las inclemencias meteorológicas. Con el fin de mantener sus muebles y los mas vibrante posible, simplemente enjuagar y usar un jabón suave para limpiar el marco. Se aconseja el uso de abrigo de muebles o el almacenamiento de los muebles cuando no esté en uso. Consulte la tabla de la mancha para el cuidado de tejidos.