

### Features

- 72"L x 36"W x 20"H.
- Six adjustable ProFlex® whirlpool jets for maximum bather comfort.
- Innovative technology enables this pump to provide a strong, steady level of hydro-massage.
- Textured bottom surface.

### Material

- Acrylic.

### Hydrotherapy

- Whirlpool.

### Installation

- Drop-in or alcove.

### Recommended Products/Accessories

- K-1283 Removable Apron
- K-1491 Bath/Whirlpool Pillow
- K-24916 Wireless Music Kit
- K-1601 Bath/Whirlpool Footstop
- K-7213 27" Cable Bath Drain
- K-7214 27" Cable Bath Drain
- K-7259 Clearflo Bath Drain
- K-23726 Drain treatment
- K-23732 Tub & shower cleaner



### Codes/Standards

ASME A112.19.7/CSA B45.10  
CSA B45.5/IAPMO Z124  
ASTM E162  
ASTM E662  
UL 1795





**KOHLER® Plastic Baths and Receptors  
Lifetime Limited Warranty  
KOHLER® Hydrotherapy Components  
Five-Year Limited Warranty**

See website for detailed warranty information.

### Available Colors/Finishes

*Color tiles intended for reference only.*

Color	Code	Description
-------	------	-------------

	0	White
	96	Biscuit
	47	Almond
	NY	Dune
	G9	Sandbar

Pump/Control Access (If Apron Is Not Used):  
20" (508 mm) W x 15" (381 mm) H

No change in measurements if connected with  
drain illustrated. (K-11677)

□ Recommended Faucet Location

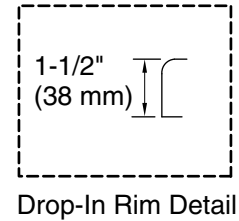
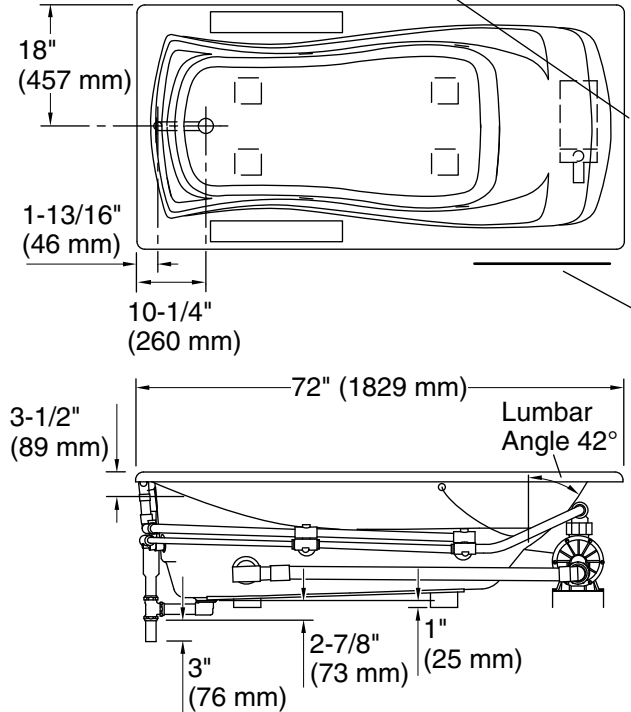

Pump/Control Access  
(If Apron Is Not Used):  
20" (508 mm) W x  
15" (381 mm) H

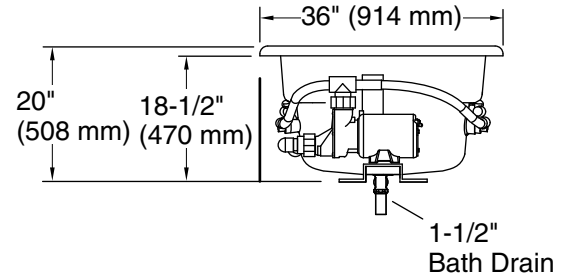

### Required Electrical Service

One dedicated circuit required, protected with Class A Ground-Fault Circuit-Interrupter (GFCI). Outside North America, this device may be known as a Residual Current Device (RCD).

Pump: 120 V, 15 A, 60 Hz

### Technical Information

All product dimensions are nominal.

Installation: Drop-in  
 Drain location: End  
 Basin area, bottom: 50" x 24" (1270 mm x 610 mm)  
 Basin area, top: 65" x 27" (1651 mm x 686 mm)  
 Weight: 110 lbs (49.9 kg)  
 Minimum floor load: 41 lbs/ft<sup>2</sup> (200.2 kg/m<sup>2</sup>)  
 Water depth: 14" (356 mm)  
 Water capacity: 72 gal (272.5 L)  
 Cutout: Drop-in, 70" x 34" (1778 mm x 864 mm)  
 Electrical component rating: Pump: 120 V, 7.5 A, 60 Hz  
 Pump speed: Single  
 Minimum flat for door: 2-1/8" (54 mm)

### Notes

Measure your actual product for rough-in details. Install this product according to the installation instructions.

The hot water supply should be 70% of the capacity of the bath or greater. Installations will vary.

If installing a rim-mount faucet, make sure there is no interference above or below the deck before drilling any holes.