

KOHLER® Faucets

1/2" Ceramic In-Wall Valve System K-302-K

Features

- For 8" (203 mm) centers.
- 1/2" quarter-turn washerless ceramic disc valves.
- 10.0 gpm (gallons per minute) flow rate.
- For use with 8-inch center, two-handle wall-mount faucets.
- Requires valve trim (sold separately).

Material

- Brass valve bodies.

Installation

- Wall-mount installation.

Optional Products/Accessories

56374 Elongated Escutcheons



Codes/Standards

ASME A112.18.1/CSA B125.1

KOHLER® Faucet Lifetime Limited Warranty

See website for detailed warranty information.

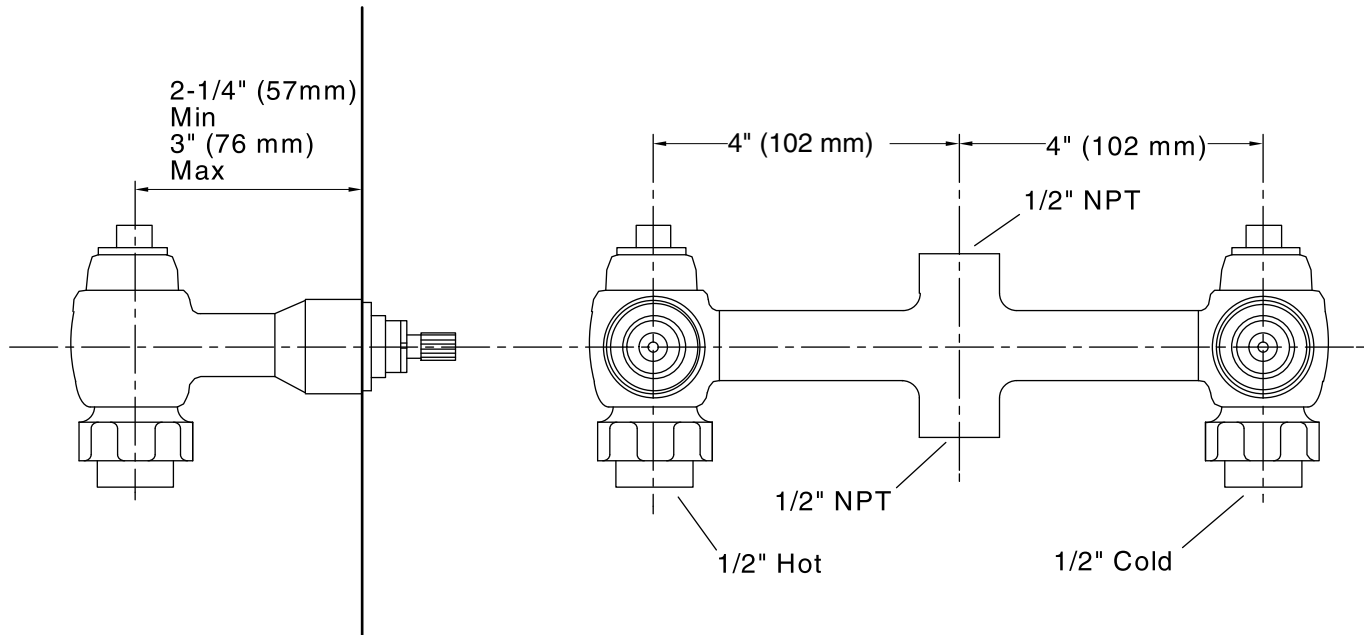

Technical Information

All product dimensions are nominal.

Shower Valve:

Flow rate - Max: 8.4 gal/min (31.8 l/min)

Pressure - Max: 45 psi (3.1 bar)