

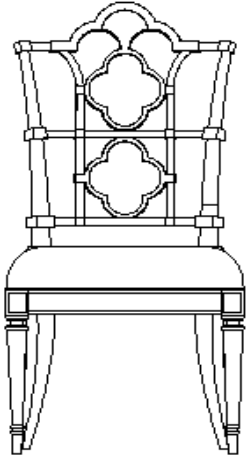





# ASSEMBLY INSTRUCTION

Item#: 1610-75510-WH Side Dining Chair-2 per carton

\*\* Please make sure you have all parts indicated below prior to assembly.

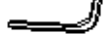

HARDWARE LIST			
No	Item	Description	Q'ty
A		FLAT WASHER	9
B		LOCK WASHER	9
C		5/16*55mm BOLT	5
D		ALLEN WRENCH	1
E		5/16*80mm BOLT	4

## Assembly Steps:

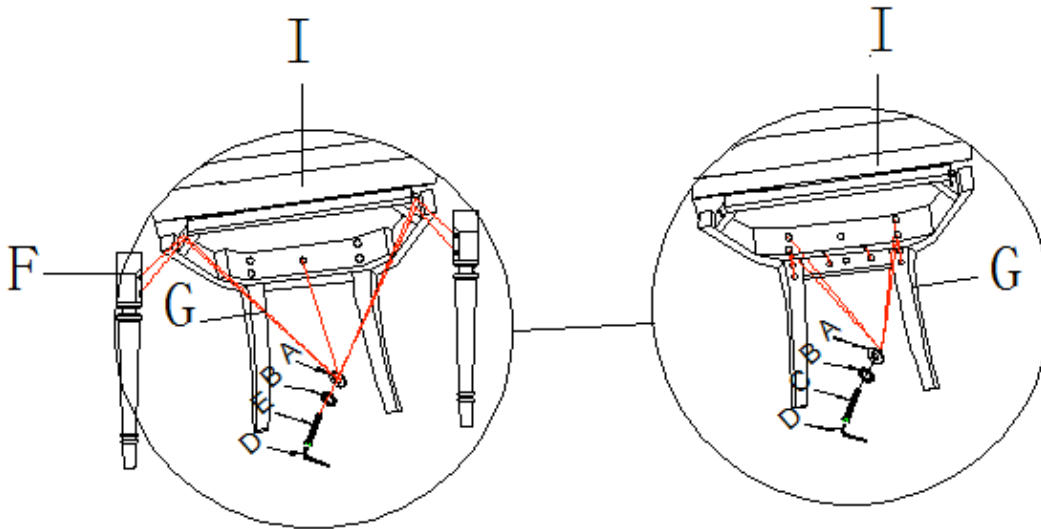

DIAGRAM 2

DIAGRAM 1

There are two K/D chairs in one box. Please follow numbers on one chair and letters on the other chair during assembly.

1. Place back frame (G) on a clean surface.
2. Tighten seat frame (I) to the back legs of frame (G) by using bolt (C), lock washer (B) and flat washer (A) at the center location (see diagram 2). Attach seat frame (I) to back legs of frame (G) using bolts (E), lock washers (B), flat washers (A). (See diagram 1)
3. Install front legs (F) onto seat frame (I) using bolts (E), lock washers (B), flat washers (A). Tighten all bolts by hand. (See diagram 2)
4. After all bolts are attached and hand tightened, turn the chair upright.
5. Level the chair following the "chair leveling instruction" as below.
6. Make sure the chair is level and then tighten all bolts completely by using the allen wrench (D).

# PLEASE READ THESE INSTRUCTIONS PRIOR TO ASSEMBLING THE CHAIRS CHAIR LEVELING INSTRUCTION SUPPLEMENT

## Chair leveling procedures:

To make the assembly process easy and efficient, please read the entire instruction sheet prior to assembling of the chair. Make sure all hardware listed is included. To properly assemble the chair, none of the bolts should be fully tightened until all components are attached to the chair. This will allow an opportunity to level the chair and prevent any unnecessary “rocking”.

1. Place the loosely assembled chair on a hard flat surface.
2. Apply gentle downward pressure on the seat. This step eliminates rocking and ensures the chair to be level.
3. Once the chair is level, tighten all bolts and nuts.

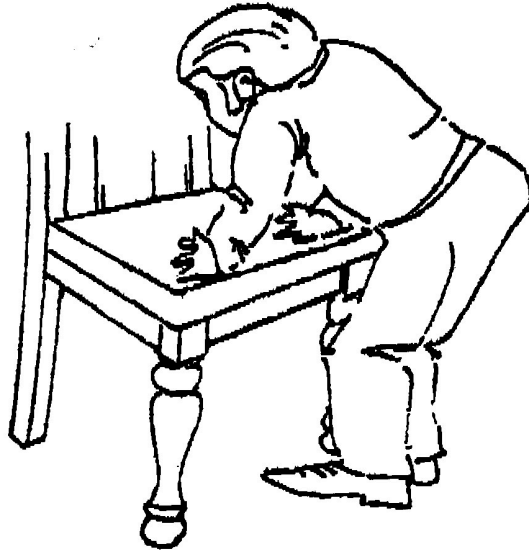

## Note:

Most floors have slight irregularities that can affect chair leveling. If your chair is uneven when placed in its desired location, perform the following steps:

1. Loosen front legs to finger tight.
2. Extend both front legs upward to their fullest length.
3. Gently push downward on the front edge of the seat until all four legs rest on the floor.
4. Re-tighten all bolts and nuts.

***Cleaning Instruction: Clean finished parts with a damp cloth using a mild dishwashing liquid and water solution. Polish the finish with soft cloth and an industry recognized furniture polish.***