

## CARE AND MAINTENANCE

Use a mild water-free solvent. Only a professional cleaner should undertake a complete overall cleaning.  
The use of steam or water-based cleaners may cause excessive shrinking or staining.









## NOTICE

Please make sure that you have all parts indicated before you begin assembly of this item.

This item should be assembled on a soft surface to prevent scratching the finish ring assembly.

This item may require periodic tightening.

## Part List and Hardware List

ITEM	DESCRIPTION	PICTURE	QUANTITY
A	SEAT		1X
B	Front leg-1		1X
C	Front leg-2		1X
D	Back leg-1		1X
E	Back leg-2		1X
H1	Allen bolt L		8X
H2	Spring washer		8X
H3	Flat washer		8X
H4	Allen key		1X

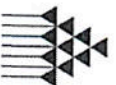
 SAFAVIEH  
FURNITURE

Model# MCR4705

Product Dimensions: 20.07 W x 24.61 D x 34.84 H

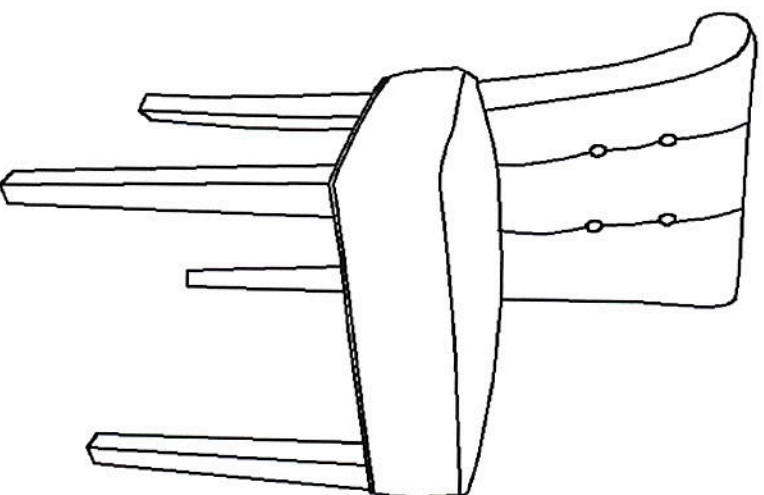

**REPARATION**

Before beginning assembly of product, make sure all parts are present. Compare parts with package contents list and hardware contents list.  
If any part is missing or damaged, do not attempt to assemble the product.  
Estimated Assembly Time: 10 minutes.  
Tools Required for Assembly (included): Allen Key

