

# 1015-22P-SC

1

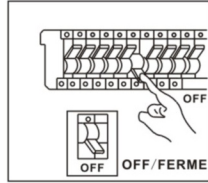

2

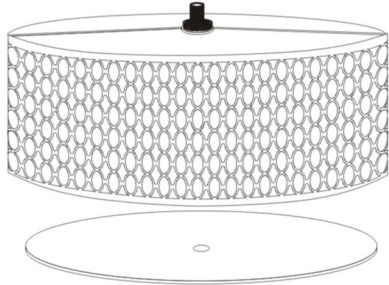
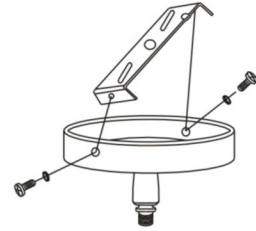

3

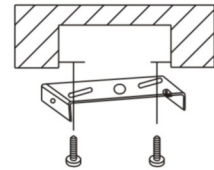

4

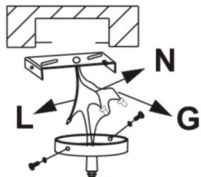

(20")

(11")

(8")

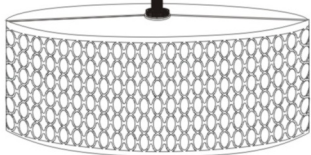

5

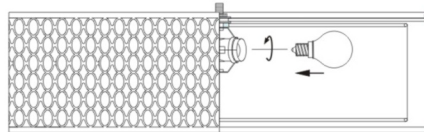

3 x E26 100W MAX  
(not included/non inclus)

6

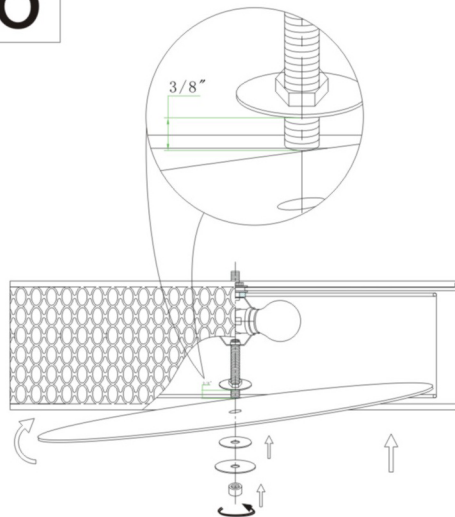

7

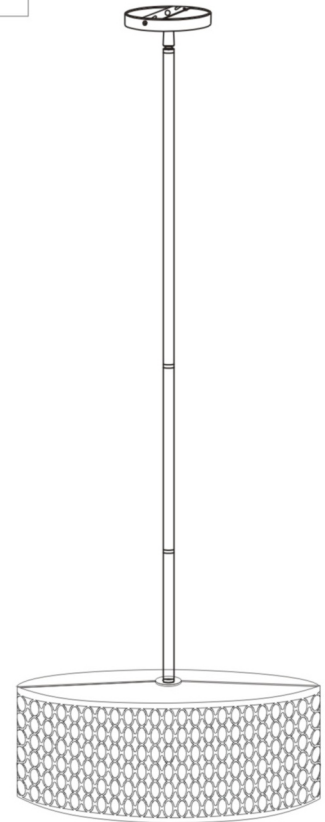

1401 Courtneypark Drive East Mississauga, Ontario, Canada L5T 2E4

Tel:(905)564-1262 Fax:(905)564-1299

E-mail:dainolite@dainolite.ca Web:www.dainolite.ca

May.16. 2012