

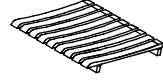

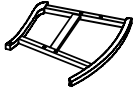

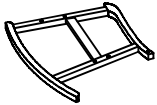



Part List

| PIECE | DESCRIPTION | PICTURE | QUANTITY |
|-------|-------------|---|----------|
| A | Back |  | 1x |
| B | Seat |  | 1x |
| C | Left side |  | 1x |
| D | Right side |  | 1x |
| E | Seat bar |  | 2x |
| F | Support leg |  | 1x |

Hardware List

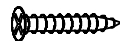
| PIECE | DESCRIPTION | PICTURE | QUANTITY |
|-------|------------------|--|----------|
| HW1 | T Bolt & nut |  M6x70 | 4x |
| HW2 | Bolt & round nut |  M6x45 | 4x |
| HW3 | Allen screw |  M6x70 | 2x |
| HW4 | Screw |  M4x35 | 4x |
| HW5 | Extra bolt |  M6x45 | 1x |
| HW6 | Allen Key |  | 2x |

JONATHAN Y

MODEL# RCK101

Product Dimension: 22.44" W x 31.10"D x 36.22"H

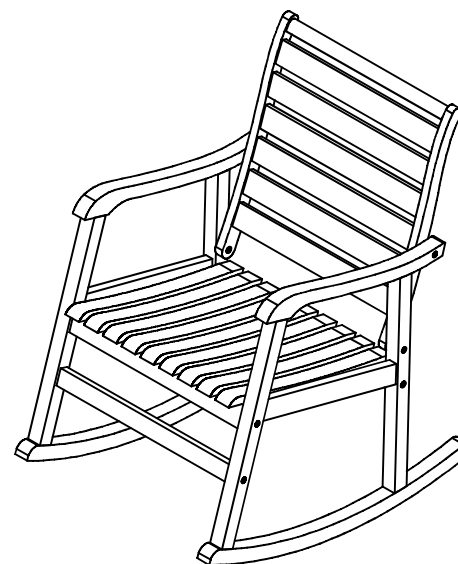



Scan the QR code on the right to view a video that shows how to assemble this product

QR CODE

PREPARATION

Tool required for assembly (included): Allen Key.

1

| | | |
|-----|---|----|
| HW1 |  | 2x |
| HW2 |  | 2x |
| HW3 |  | 1x |

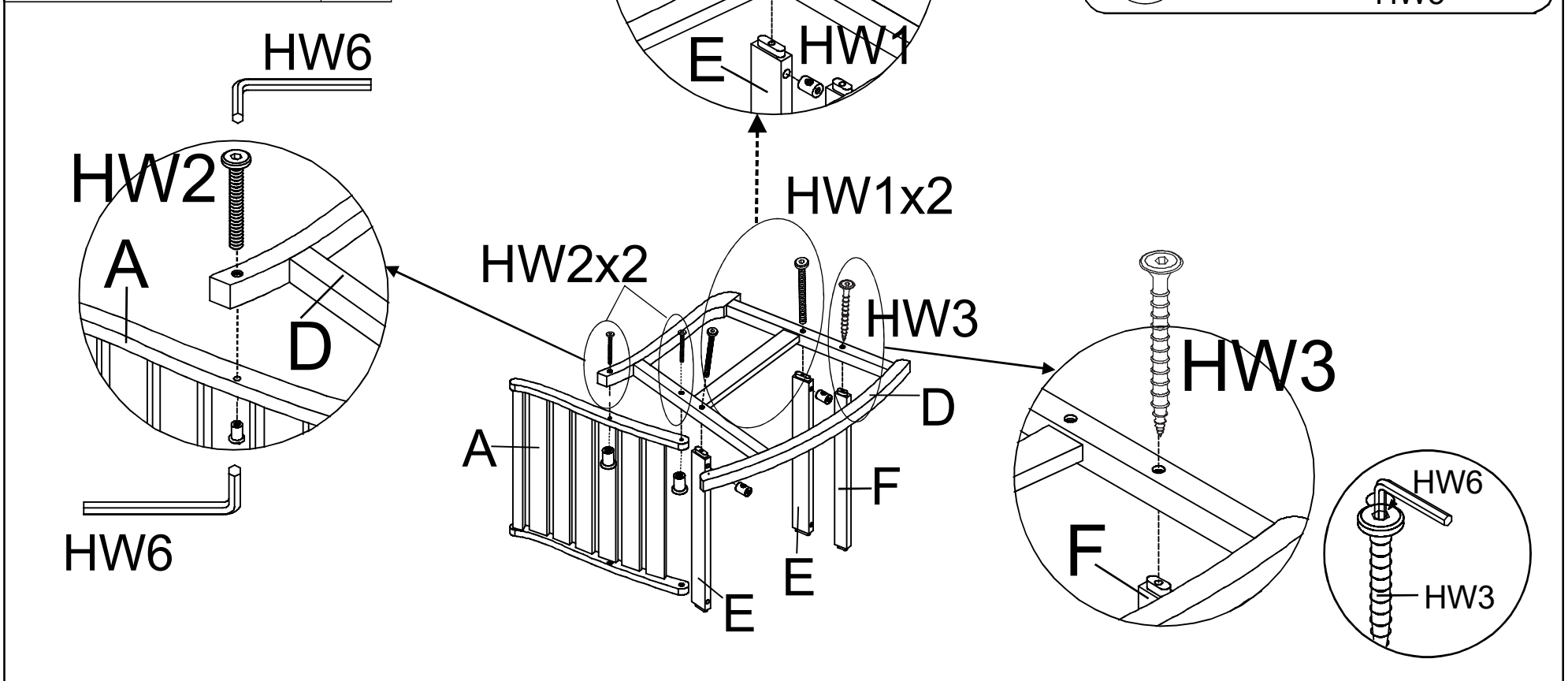



Step 1: Attach the Back (A), Seat Bar (E), Support Leg (F) to the Right side (D) as shown on the picture. Using the T bolt & nut (HW1), Bolt & Round nut (HW2) and Allen screw (HW3) to fix it together by using the Allen key (HW6) and Extra bolt (HW5) as shown on these pictures.

PREPARATION

Tool required for assembly (included): Allen Key.

2

| | | |
|-----|--|----|
| HW1 |  M6x70 | 2x |
| HW2 |  M6x45 | 2x |
| HW3 |  M6x70 | 1x |

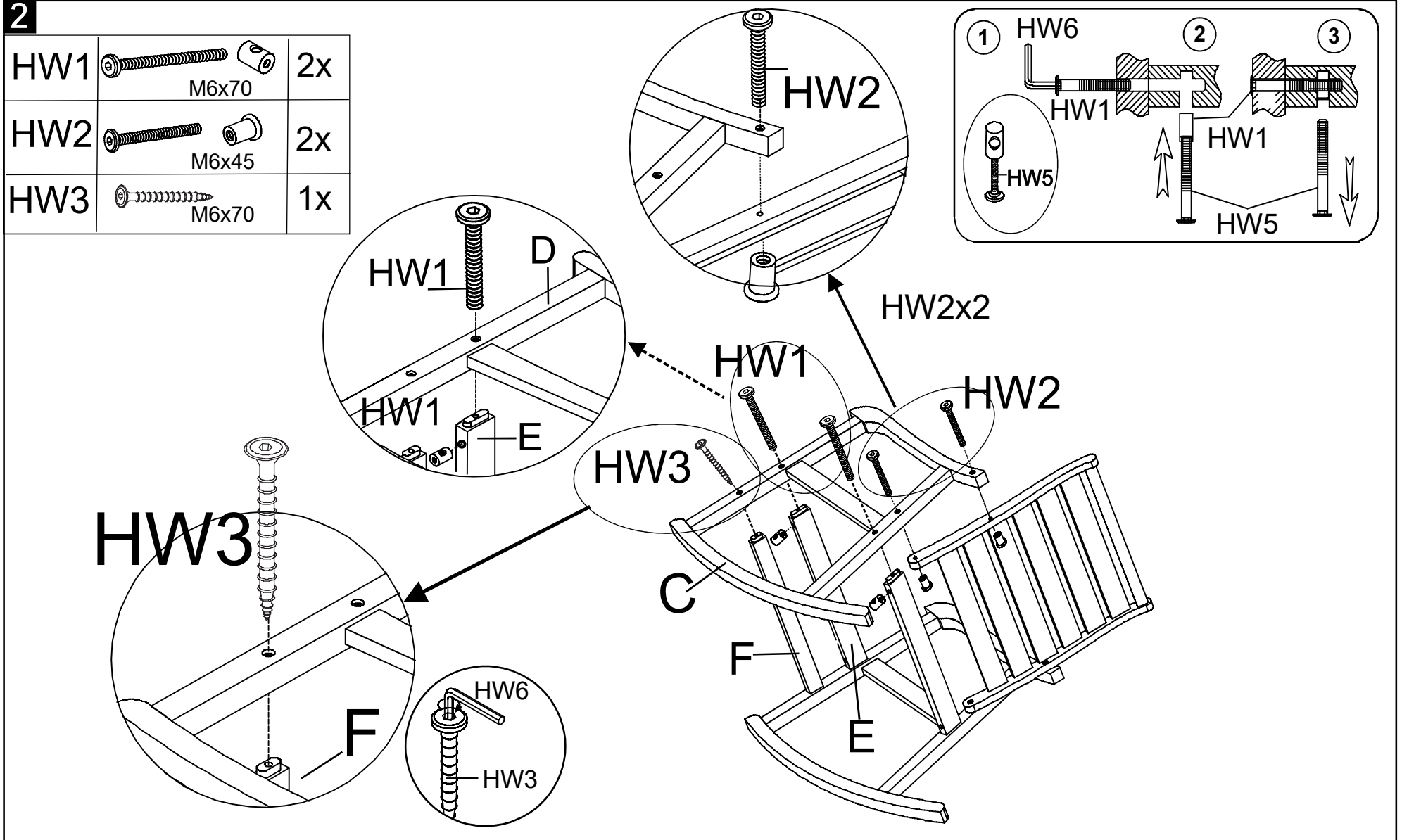

Step 2: Attach the Left side(C) to Seat Bar (E) , Support Leg (F) and the Back (A) as shown on the picture .Using the T bolt &nut (HW1) , Bolt & Round nut (HW2) , Allen screw (HW3) to fix all together by using the Allen key (HW6) and Extra bolt (HW5) as shown on these pictures .

PREPARATION

Tool required for assembly : Screw driver.

3

HW4

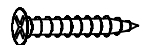

M4x35

4x

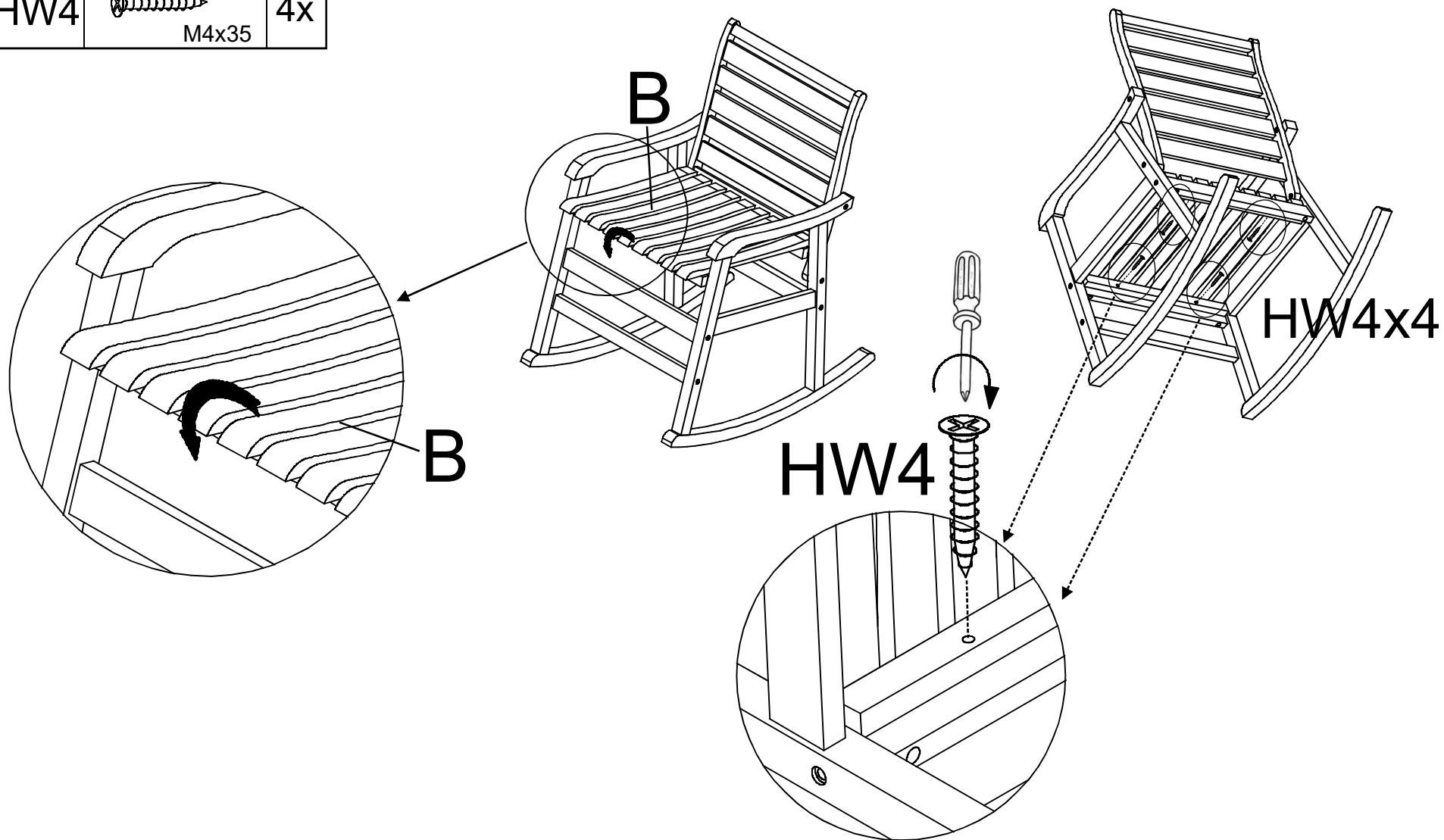

Step 3: Put the Seat (B) to the chair and using the Screw (HW4) to fix it by using the Screw driver as shown on the picture .