

WYNDHAM COLLECTION

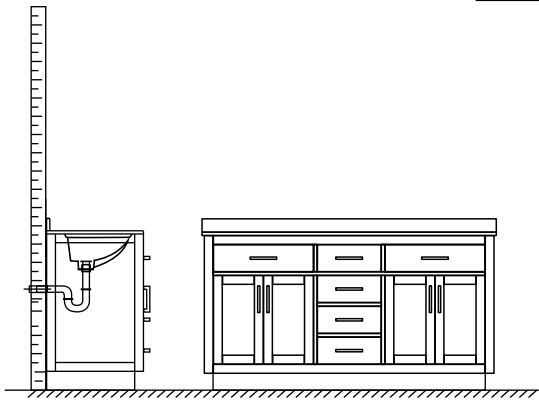

- Prior to installation please check received items against the "Packing List". Please report any missing items to your retailer immediately.
- Protect all surfaces from sharp objects, high heat sources, direct prolonged sunlight and chemical hazards.
- Professional installation recommended.
- Backsplash comes in two pieces.

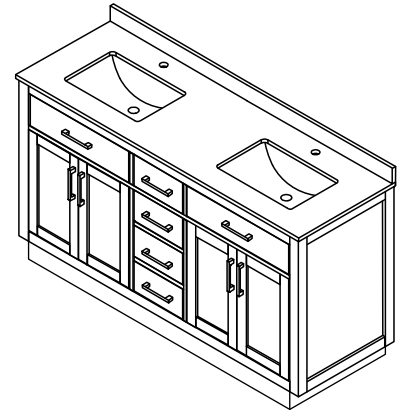

PACKING LIST

(Not all components may be included, depending upon your purchase)

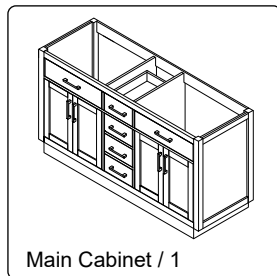
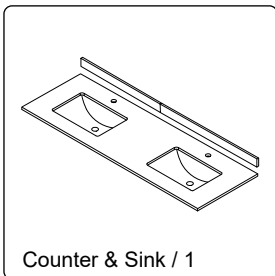

HOW TO ADJUST HINGES (if required)

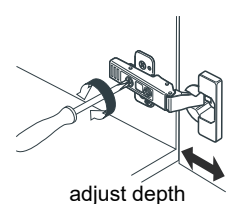
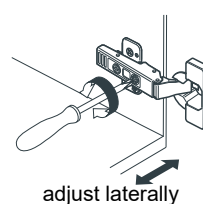
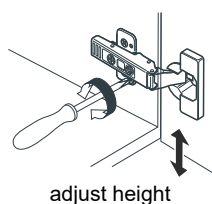
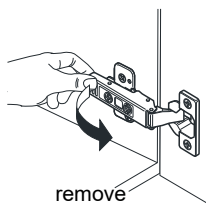
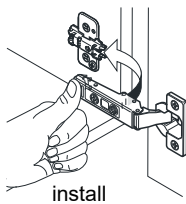

REQUIRED TOOLS NOT IN BOX

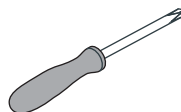
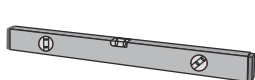

WC-2626-66-DBL Installation Guide

WYNDHAM COLLECTION

INSTALLATION INSTRUCTIONS

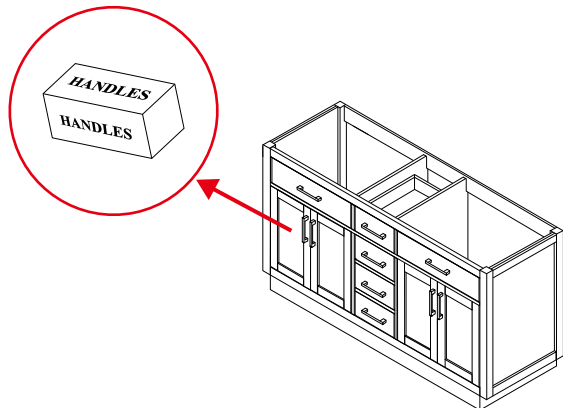

- ① The handles are safely stored for transport in a box inside of the cabinet. Look inside the vanity for the box with your handles.

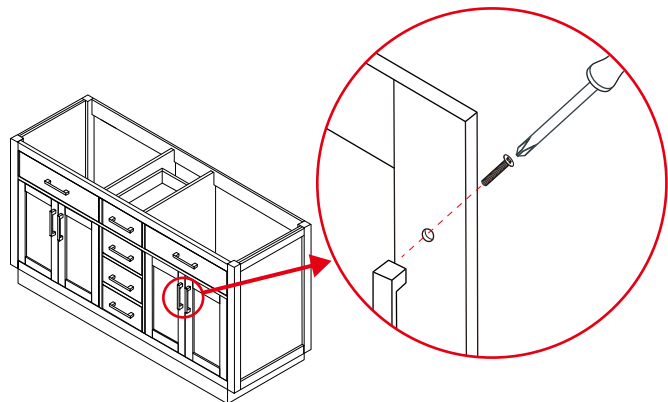

- ② Unpack the handles and install them on the vanity. Do not over tighten when attaching.

Short, for door handles

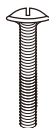

Long, for drawer handles

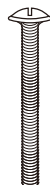

- ③ Short screws are for the door handles and long screws are for the drawer handles.

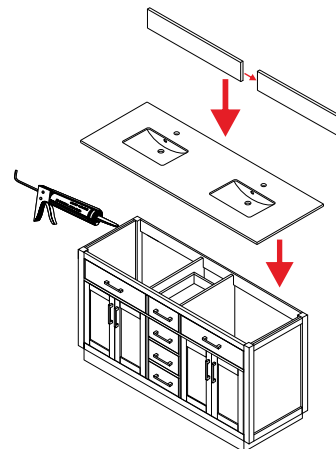

- ④ Install the counter. Seal around the top of the cabinet with clear silicone sealant. Do not over apply. Allow to dry 24 hours for proper curing.

WC-2626-66-DBL
Installation Guide