



INSTALLATION

PIONEER INDUSTRIES, INC.
 3325 S. Garfield Ave.
 Commerce, CA 90040
 (800) 338-9468
 www.pioneerind.com

Tools:



Adjustable Wrench Phillips screwdriver Plumbers Putty Teflon Tape Rags

Model Number: 2LG220



Warnings and Notes:

Check with local plumbing code requirements before installation.
 This product should be installed by a local listed plumber.
Do not use plumbers putty on threads.

Installation Steps:

Single Handle Pull-Out Kitchen Faucet

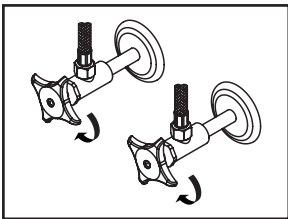

(1) Shut off water supplies. Remove old faucet. Clean mounting surface in preparation for new faucet.

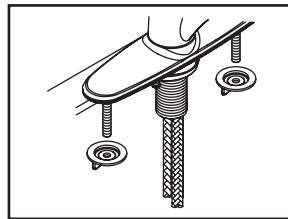

(3b) Thread and tighten both mounting nuts to mounting bolts from underneath of the sink to secure deck plate.

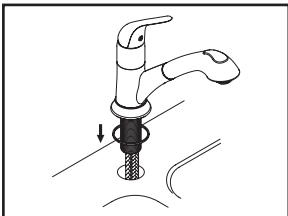

(2a) **For 1-Hole Installation:-** Make sure washer is under escutcheon, slide escutcheon for 1-hole installation to the faucet body. Insert faucet through mounting hole. Make sure spout swivel angle are even to the right and to the left.

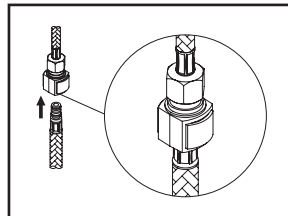

(4) Insert spray head hose into end of quick connect adapter on the outlet hose, push until a "click" is heard. Pull down to test engagement.

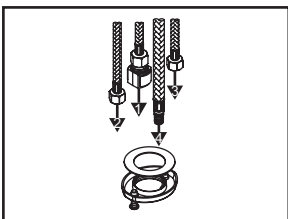

(2b) Please follow the order as drawing shows to insert flex hose through center hole of the locknut from underneath of the sink.

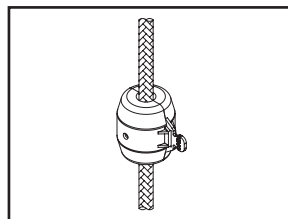

(5) Install weight on spray head hose. Adjust weight's position so the spray head can be retracted properly.

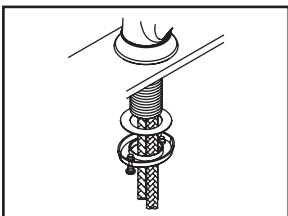

(2c) From underneath of the sink hand-tighten locknut to the faucet. Position faucet to desired location from top. Tighten screws on locknut with the help of Phillips head screwdriver to secure faucet.

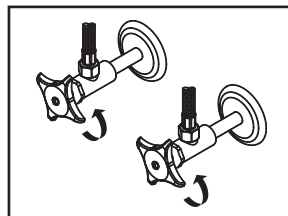

(6) Connect hot and cold inlet supply hoses to supply stops. For 1/2" connection; use 3/8" male to 1/2" female adapter for installation. Adapters are optional and not provided with faucet. Turn on both side supply stops.

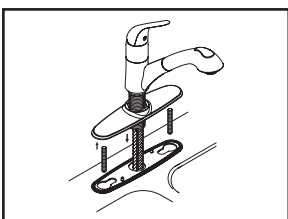

(3a) **For 3-Hole Installation:-** Place faucet on the deck plate, make sure spout swivel angle are even to the right and to the left, hand-tighten locknut to the faucet, tighten screws on locknut with the help of Phillips head screwdriver to secure the faucet. Thread mounting bolts to deck plate, apply plumbers putty under the base gasket and lead inlet & outlet flex hoses through center mounting hole to place faucet with base gasket in position on the sink.

Exploded Drawing

* Note: Please specify finish/color when ordering.

	ITEM #	DESCRIPTION
A	X-1200001*	Lever Handle
B	OP-420028*	Cap
C	OP-420042	Retainer Nut
D	X-3900001	Ceramic Disc Cartridge
E	X-4200183*	1.8 GPM Spray Head
F	X-4200197	Spray Hose
G	X-4200148	Spray Head Support
H	X-4200151*	Deck Plate & Base Gasket
I	X-4200152*	Escutcheon & Washer
J	X-5200006	Mounting Bolts & Nuts
K	X-4200199	Quick Connect
L	OP-520015	Locknut with Screws
M	OP-420070	Weight
1	X-4900001	Hole Cover
2	X-4900002	Allen Screw
3	OP-420010	O-Ring

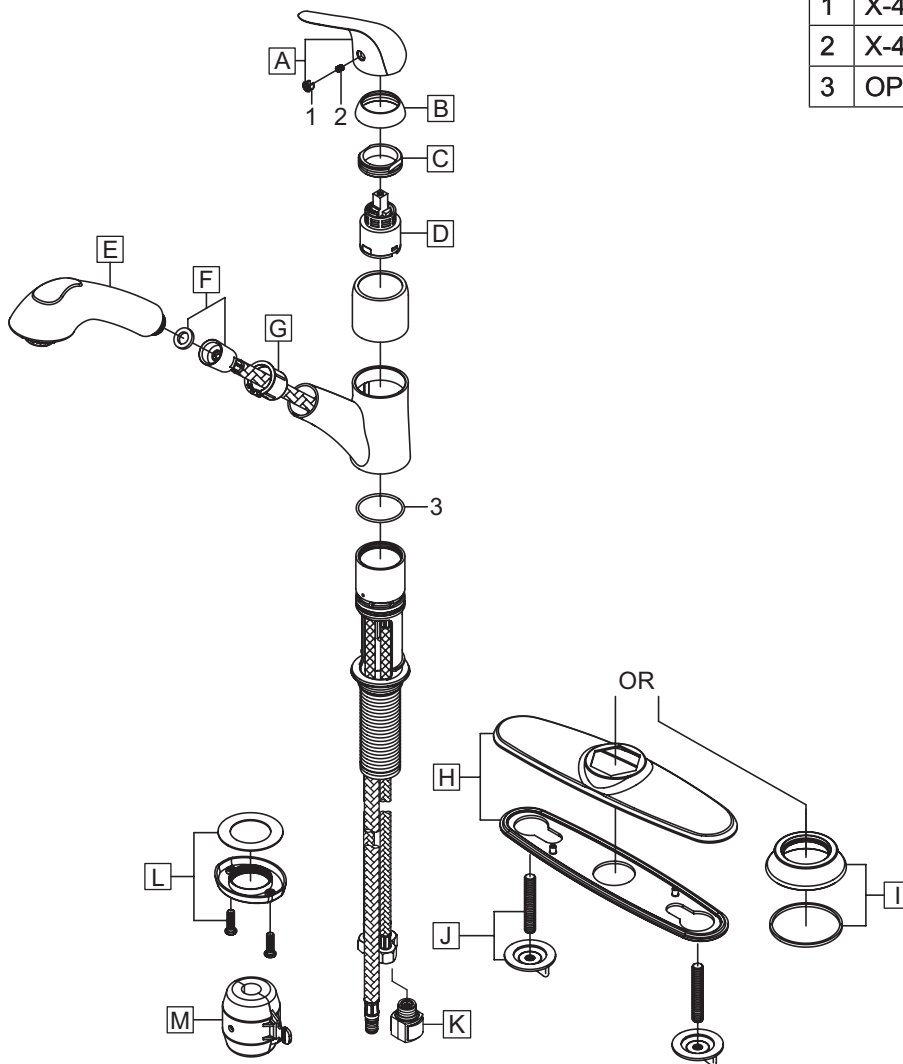

For more care information or trouble shooting inquiries about your Pioneer product, please call:
Pioneer Industries, Inc. (800) 338-9468
 Monday-Friday 8 AM to 8 PM EST (5 AM to 5 PM PST)
www.pioneerind.com