

XA-F-60X38-GG
Assembly Instructions

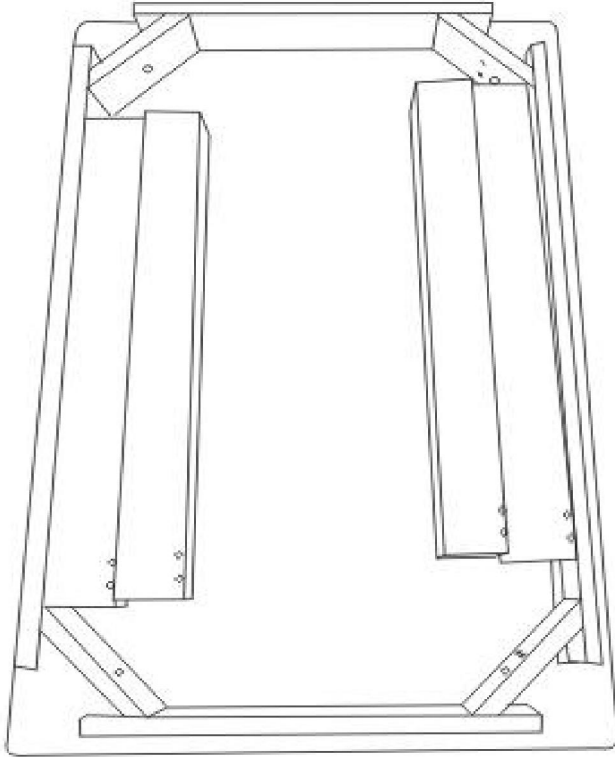

Step1:
Open the box and take out the legs.

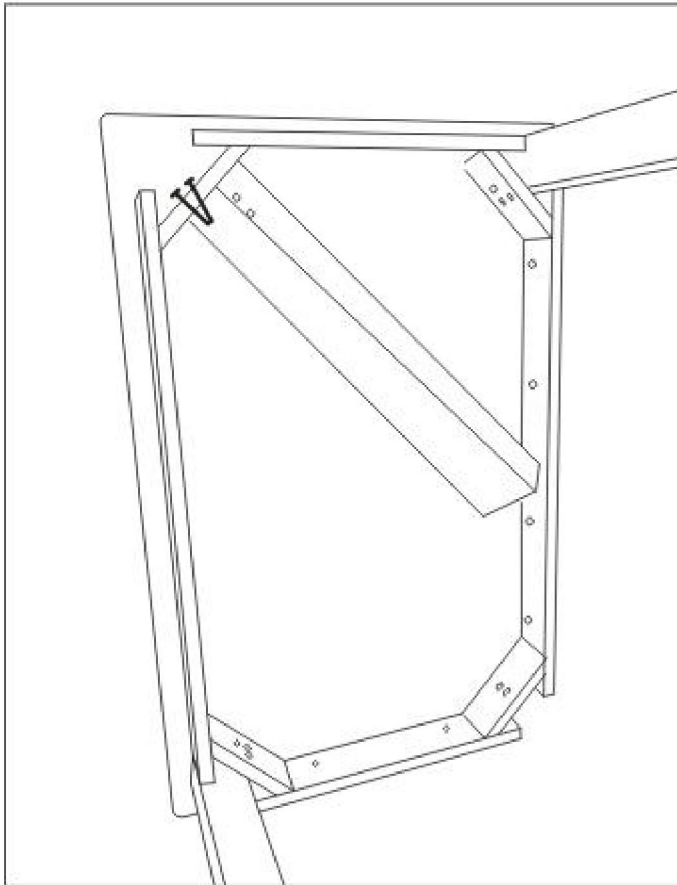

Step2:
Find out the spare parts bag, take out the bolts,nuts,washers,wrench

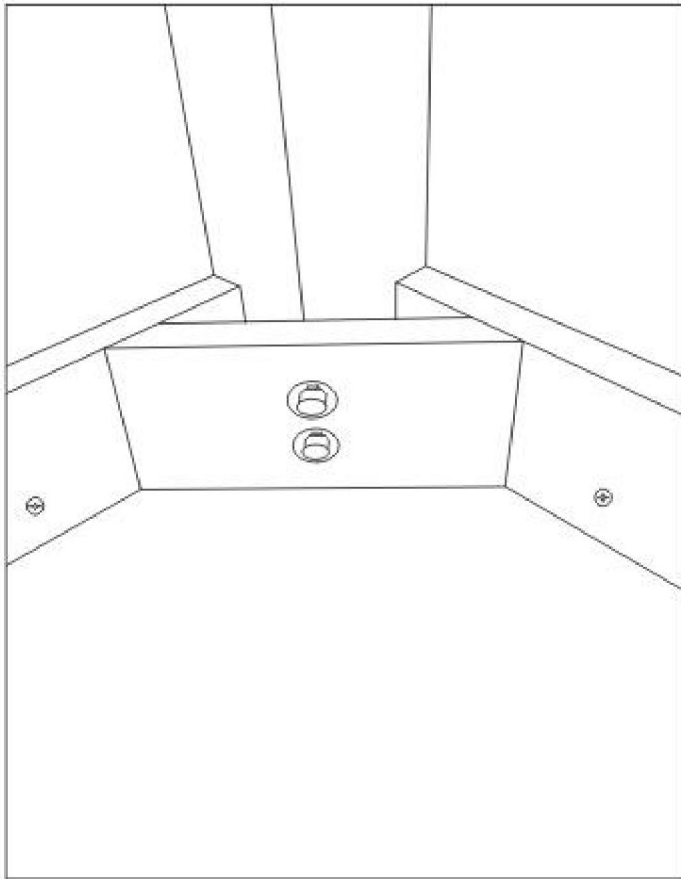

Step3. :
Use the Wrench to fix the bolts on
each legs.

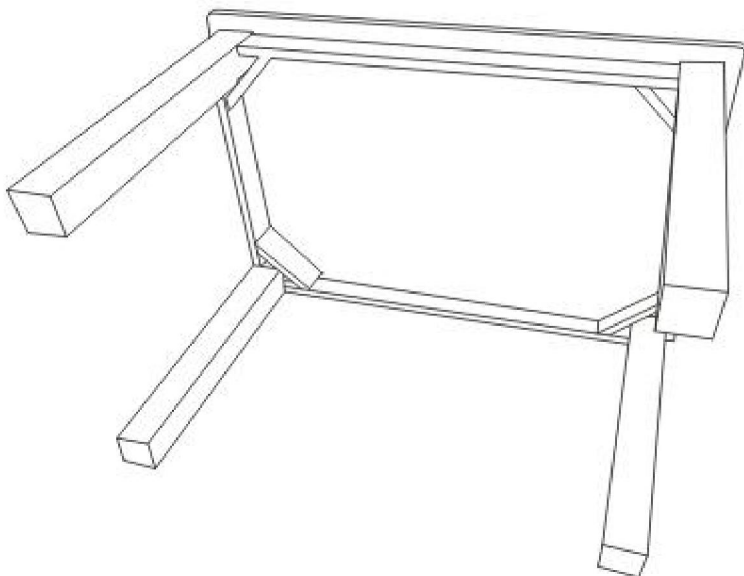

Step4. :
Finish fixing and turn the table around.