

ENCLO

HIDE IT WITH STYLE

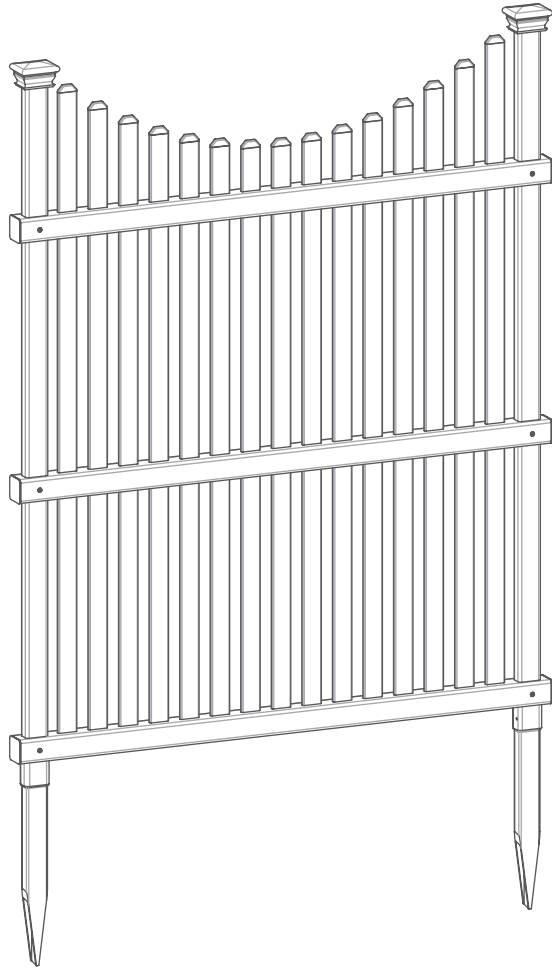

Huntersville Vinyl Screen 2-Pack 36" W x 45" H

60 min
Approximate assembly
time for 2 screens



Scan the QR code
for an assembly video



**ASSEMBLY
INSTRUCTIONS**
ZP19036

www.encloscreens.com

VER. 090622

GENERAL INFORMATION



IMPORTANT

- Check the inside of the larger pieces in your box for other materials packed inside.
- When assembling components, place on a non-abrasive surface (i.e. shipping box) to avoid scratching.
- We recommend an area approximately 5'x 8' for unobstructed assembling.
- You should not need to use excessive force when assembling components.

MISSING OR DAMAGED PARTS?

VISIT OUR WEBSITE FIRST, SO WE CAN HELP YOU RIGHT AWAY!

Although great care has been taken to ensure proper packaging and handling of this product, occasionally problems occur. If you discover any missing, damaged or defective parts, please visit our website to order replacement parts. If you experience any further trouble with your product, please contact our customer service department.

 parts.nychbrands.com

 support@encloscreens.com

 **704-892-5222 / 877-234-6196**

Customer service agents are available to take calls weekdays from 9am-5pm EST. If you call outside of business hours, please leave a voicemail.

To help you quickly and accurately, please have reference item number **ZP19036** and the specific part name which can be found on page 4. It is helpful if you can provide the batch lot which is a stamped number on the end of the box.

NEED ASSEMBLY HELP?

If you are having problems with the assembly or installation of this product, we are happy to assist you with the process, **so please give us a call at 704-892-5222 / 877-234-6196**







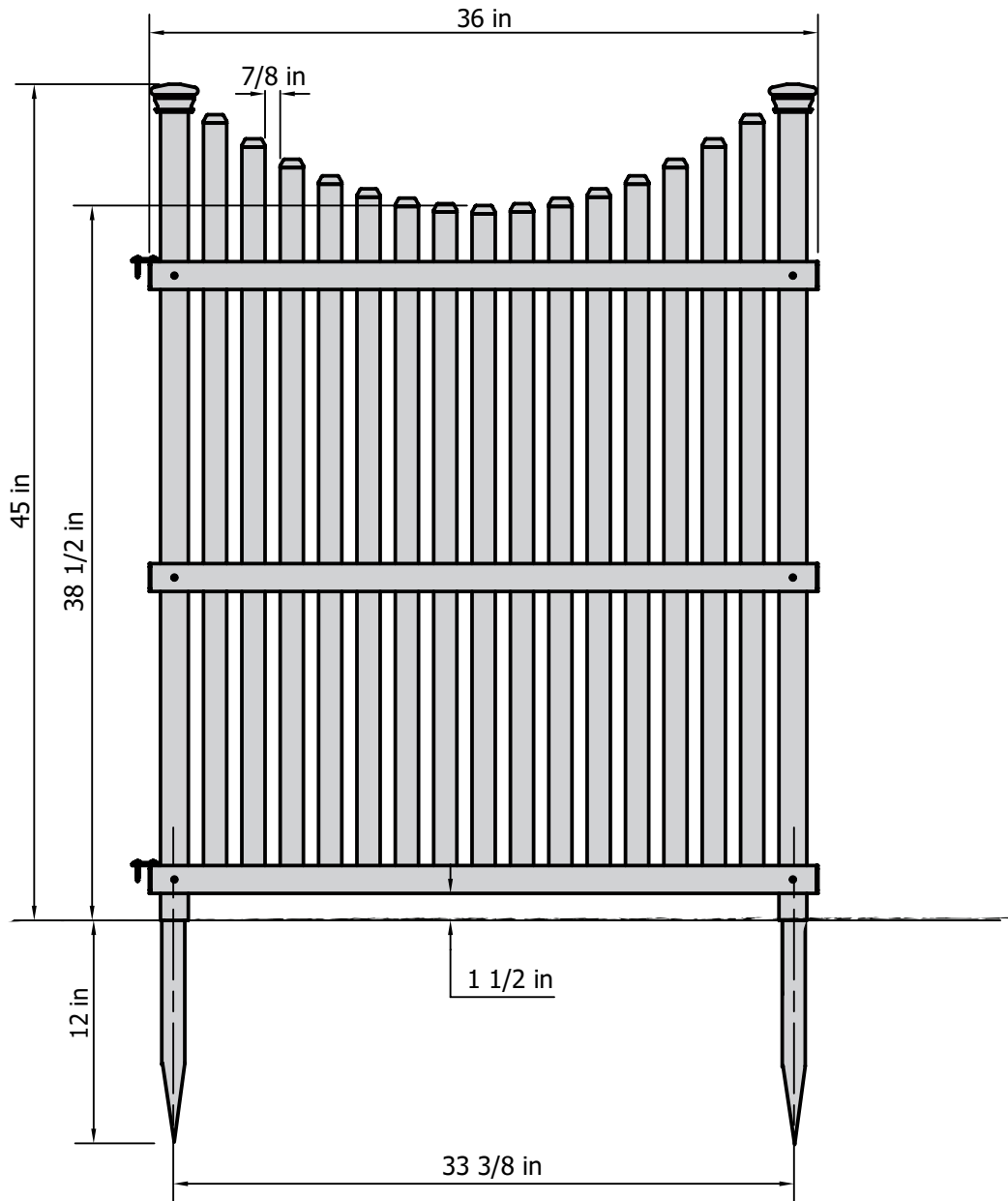

NEED TO RETURN?

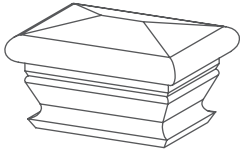
If for some reason you need to return this product, please allow us to help resolve your issues first. If you still decide to return the product, **you will need to initiate the return from the company you originally purchased from.**

Detailed Product Dimensions & Specifications

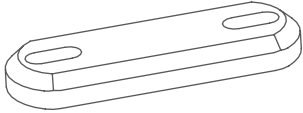
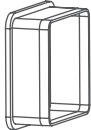

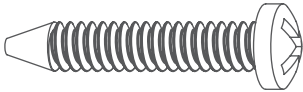
STEP 1: LAY OUT MATERIALS

<p>A</p>  <p>Post Cap (4)</p>	<p>B</p>  <p>Post (4) 7/8" x 1 1/2" x 44 1/2"</p>	<p>G</p>  <p>Post Anchor (4) 3/4" x 1 1/4" x 16"</p>								
<p>C</p>  <p>Top and Middle Rail (4) 1 1/2" x 1 1/2" x 36"</p>		<p>H</p>  <p>Joiner Clip (4)</p>								
<p>D</p>  <p>Rail End Cap (12) (6 installed, 6 loose)</p>	<p>E</p>  <p>Pickets</p> <table border="0"> <tr> <td>Picket #1 (4) 1/4" x 1 1/4" x 41 13/16"</td> <td>Picket #5 (4) 1/4" x 1 1/4" x 37 7/8"</td> </tr> <tr> <td>Picket #2 (4) 1/4" x 1 1/4" x 40 9/16"</td> <td>Picket #6 (4) 1/4" x 1 1/4" x 37 3/8"</td> </tr> <tr> <td>Picket #3 (4) 1/4" x 1 1/4" x 39 1/16"</td> <td>Picket #7 (4) 1/4" x 1 1/4" x 37 1/16"</td> </tr> <tr> <td>Picket #4 (4) 1/4" x 1 1/4" x 38 9/16"</td> <td>Picket #8 (2) 1/4" x 1 1/4" x 36 15/16"</td> </tr> </table>	Picket #1 (4) 1/4" x 1 1/4" x 41 13/16"	Picket #5 (4) 1/4" x 1 1/4" x 37 7/8"	Picket #2 (4) 1/4" x 1 1/4" x 40 9/16"	Picket #6 (4) 1/4" x 1 1/4" x 37 3/8"	Picket #3 (4) 1/4" x 1 1/4" x 39 1/16"	Picket #7 (4) 1/4" x 1 1/4" x 37 1/16"	Picket #4 (4) 1/4" x 1 1/4" x 38 9/16"	Picket #8 (2) 1/4" x 1 1/4" x 36 15/16"	<p>I</p>  <p>3/4" Self-Tapping Stainless Steel Screw (36) > Bag A</p>
Picket #1 (4) 1/4" x 1 1/4" x 41 13/16"		Picket #5 (4) 1/4" x 1 1/4" x 37 7/8"								
Picket #2 (4) 1/4" x 1 1/4" x 40 9/16"	Picket #6 (4) 1/4" x 1 1/4" x 37 3/8"									
Picket #3 (4) 1/4" x 1 1/4" x 39 1/16"	Picket #7 (4) 1/4" x 1 1/4" x 37 1/16"									
Picket #4 (4) 1/4" x 1 1/4" x 38 9/16"	Picket #8 (2) 1/4" x 1 1/4" x 36 15/16"									
<p>F</p>  <p>Bottom Rail (2) 1 1/2" x 1 1/2" x 36"</p>	<p>Note: the bottom rail only has picket slots on one side.</p>	<p>J</p>  <p>1/8" Steel Drill Bit (1)</p>								

STEP 2: ASSEMBLE SCREEN FRAME

STEP 2.1

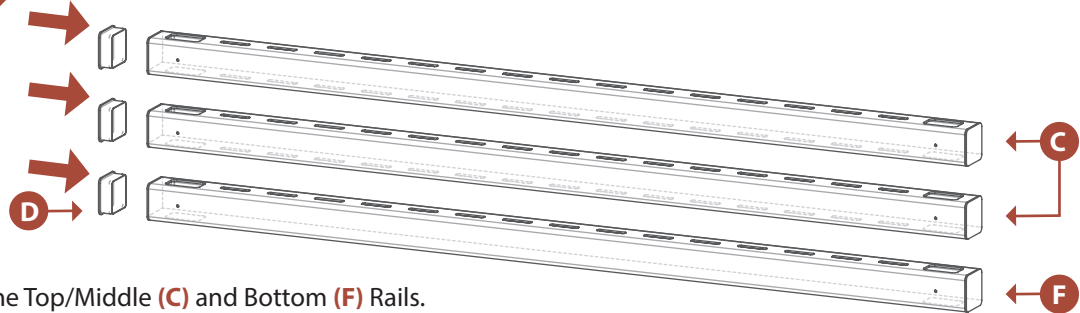

Identify the Top/Middle (C) and Bottom (F) Rails.
Fit the three loose Rail End Caps (D) into the ends of the rails.

STEP 2.2

Position the two Posts (B) as illustrated, and slide the top and middle rails down the posts, towards the locking tabs.

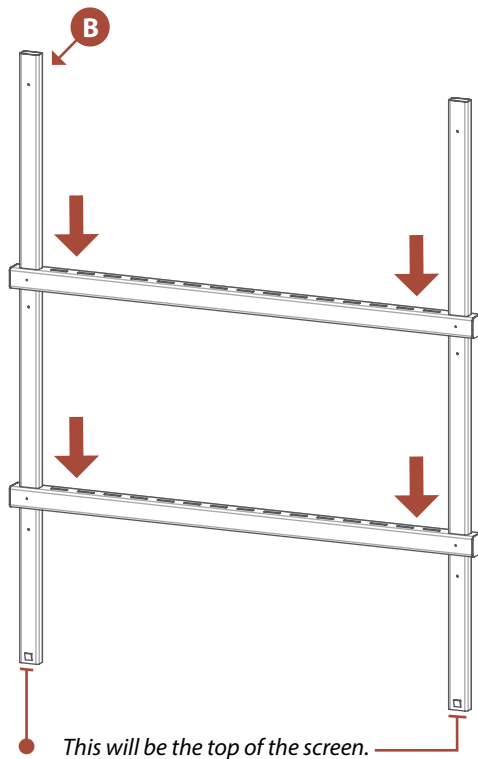

Tip: Shine a flashlight down the end of the posts to help identify alignment of pre-drilled holes.

STEP 2.3

Align the pre-drilled holes in the top and middle rails with the pre-drilled holes in the posts. Fasten together using (8) $\frac{3}{4}$ " Self-Drilling Stainless Steel Screws (I).

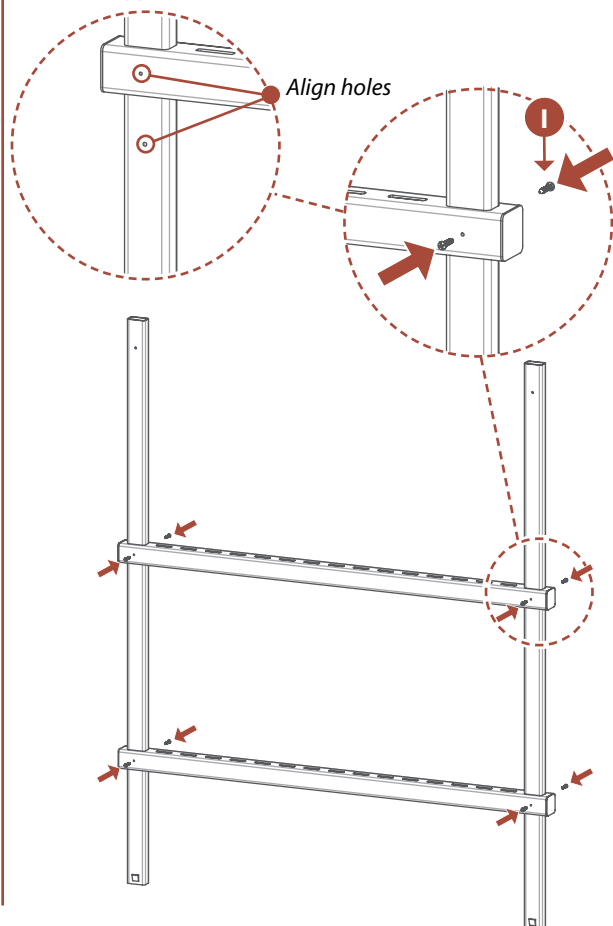

STEP 3: ASSEMBLE FENCE PANEL

STEP 3.1

1. Slide the Post Anchors (G) into the post until the pre-drilled hole in the anchor aligns with the pre-drilled hole in the post.
2. Drive (2) 3/4" self-drilling stainless steel screws into the pre-drilled holes in the posts.
3. Use the 1/8" Drill Bit (J) to drill (4) total holes in the post anchor through the pre-drilled holes in the bottom rail.
4. Drive (4) 3/4" self-drilling stainless steel screws into the pre-drilled holes in the bottom rail.

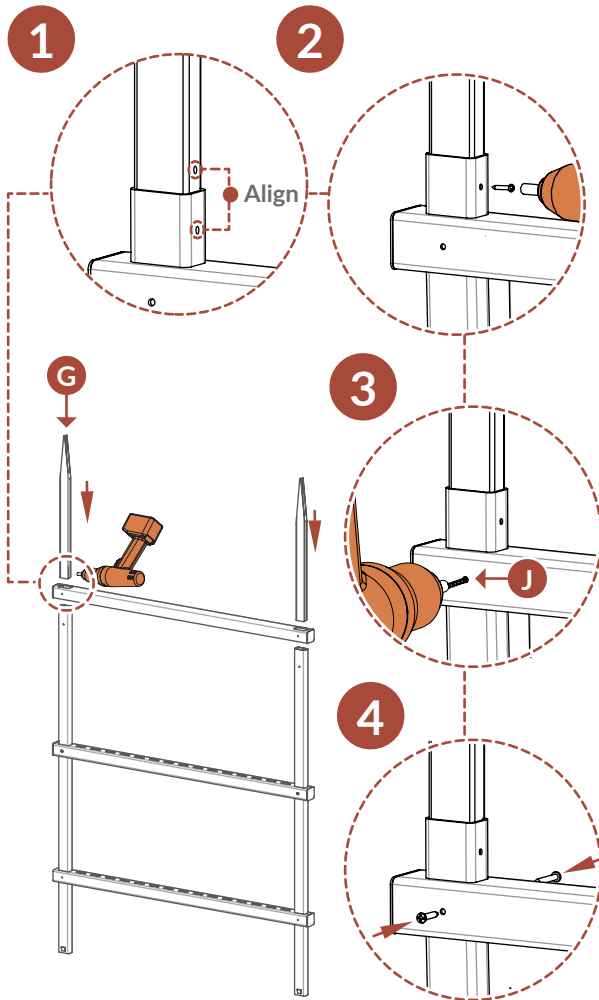

STEP 3.2

1. One by one, guide the numbered Pickets (E) through the middle rail and then through the top rail to avoid having to push the tabs through all 3 rails.
2. Push the pickets down into the bottom rail to lock into place.

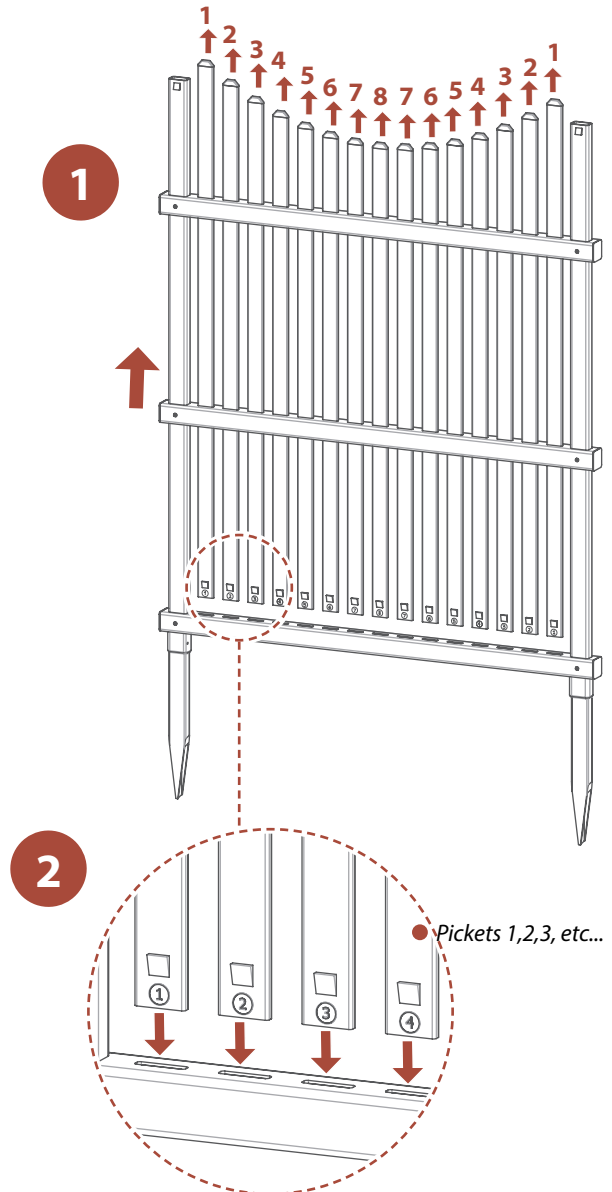

STEP 3.3

Repeat steps 1 through 3 for your second screen.

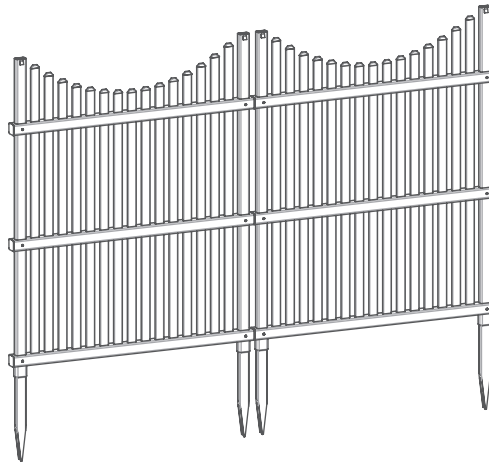
**STEP 4: INSTALL SCREEN INTO GROUND****STEP 4.1**

Move the screen to its final location, and identify the location of the posts.

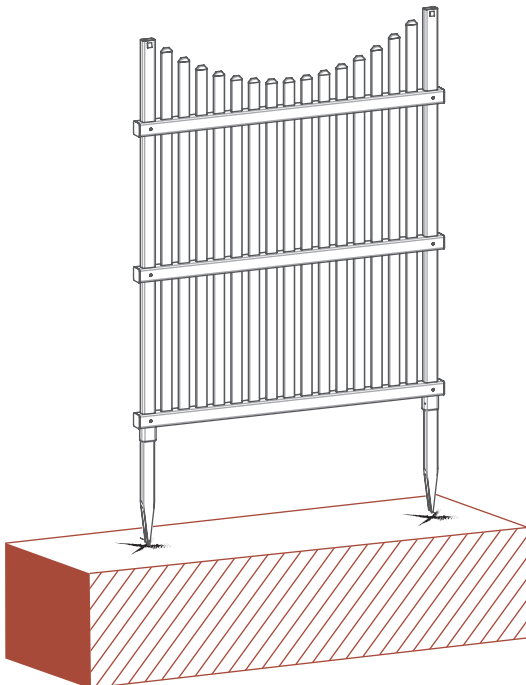
**STEP 4.2**

Attempt to push the unit into the ground as illustrated. All 12" of the post anchors should be inserted into the ground, so that they are no longer visible.

Push down
on the top
of the posts
with both
hands.

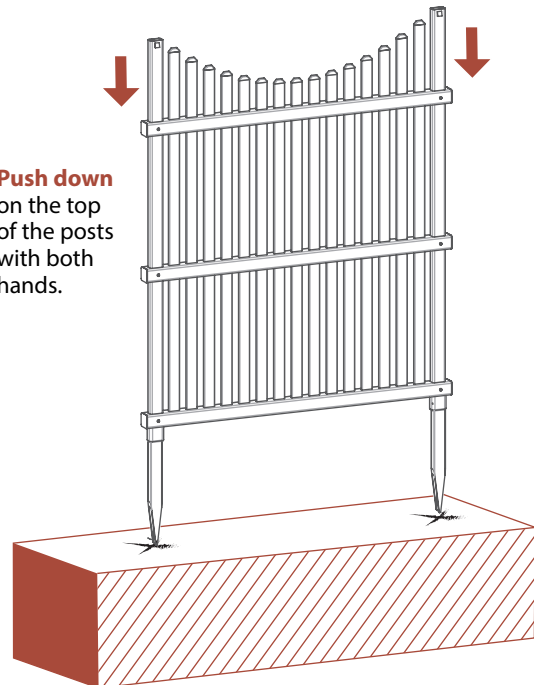

STEP 4.3

1. Loosen the top 6" or 7" of the ground with a claw hammer as illustrated.
2. Add water to loosen soil.
3. Use a block of wood to protect the top of the post, and gently hammer the post into the ground.

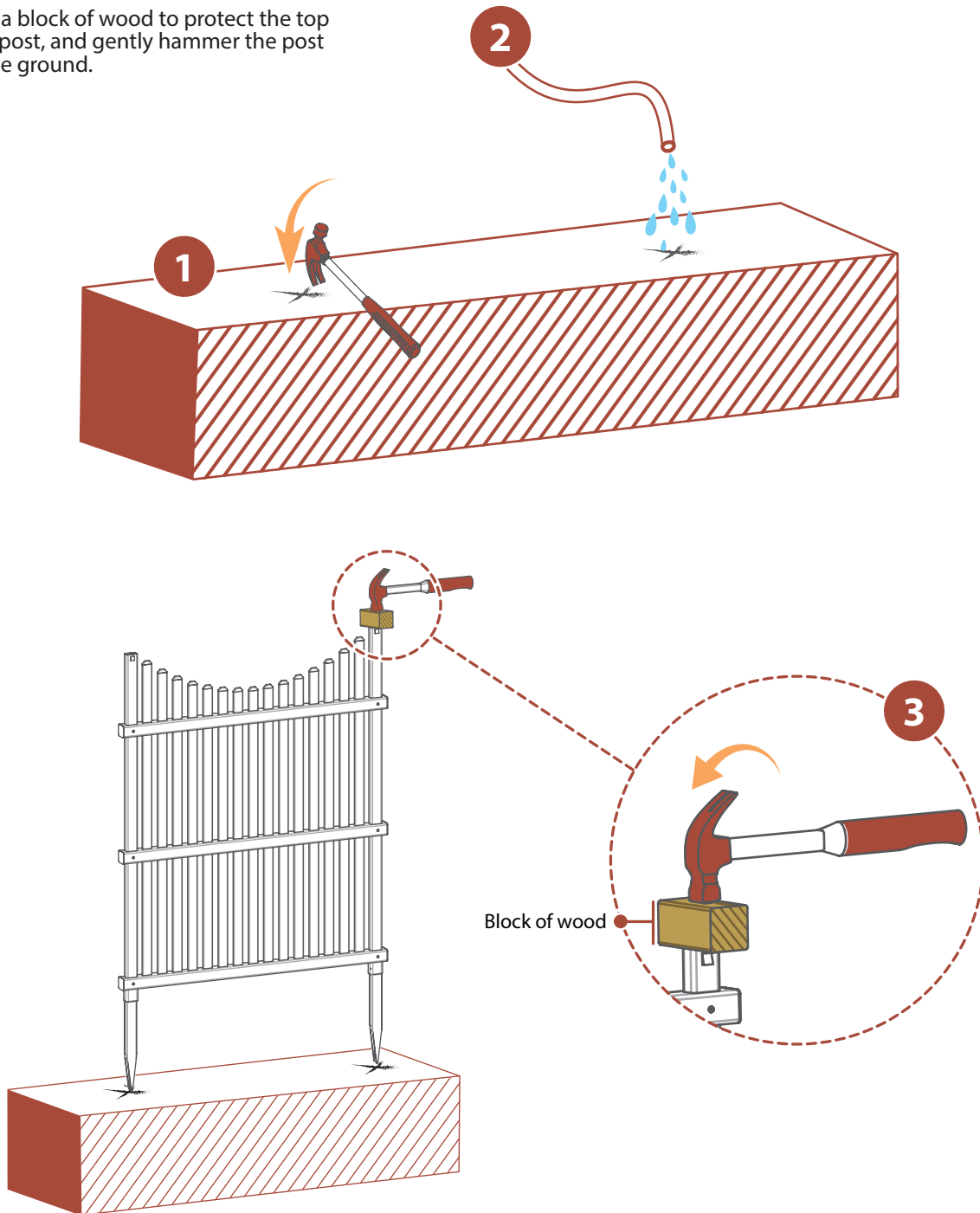

STEP 4.4

► **Optional in hard ground:** If your ground is too hard, or you have more than 3 or 4 panels to install, please consider these options:

1. Use a 1¼" diameter auger bit (commonly used for planting tulips) as illustrated (\$15-\$20 on Amazon.com).
2. Drill a hole about 12" to 16" deep at the desired location, and fill the holes with water as illustrated.
3. Push the panel posts into the holes.

1

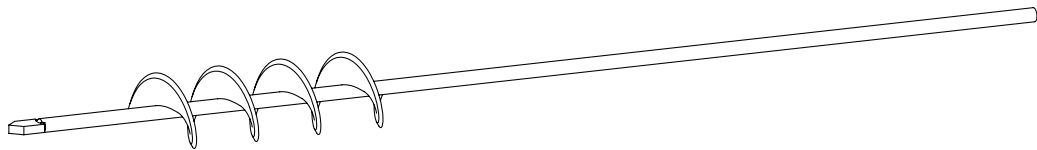

2

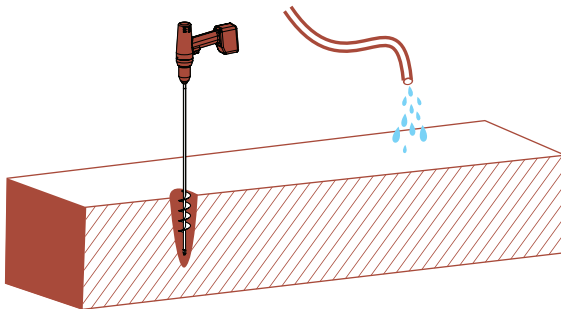

3

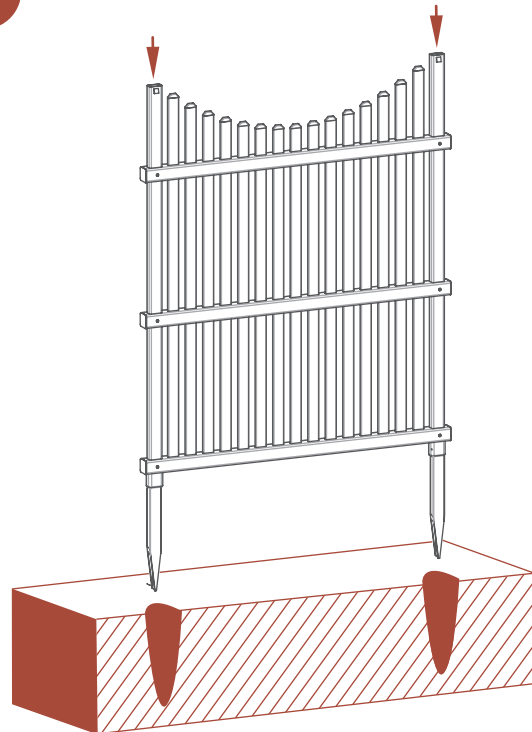

STEP 4.5

Level the screen as necessary, then backfill and compact the excavated dirt.

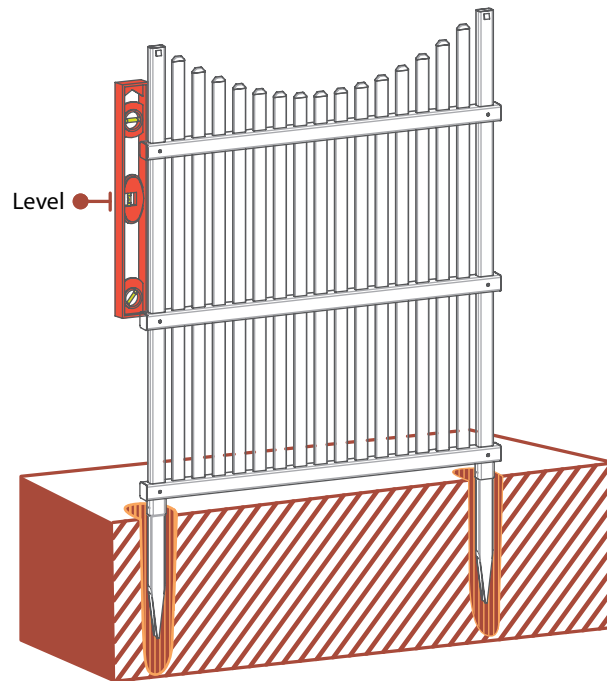
**STEP 4.6**

If your ground is really hard, you may need to dig a hole large enough to accommodate one post from each screen into the same hole. Backfill and compact dirt.

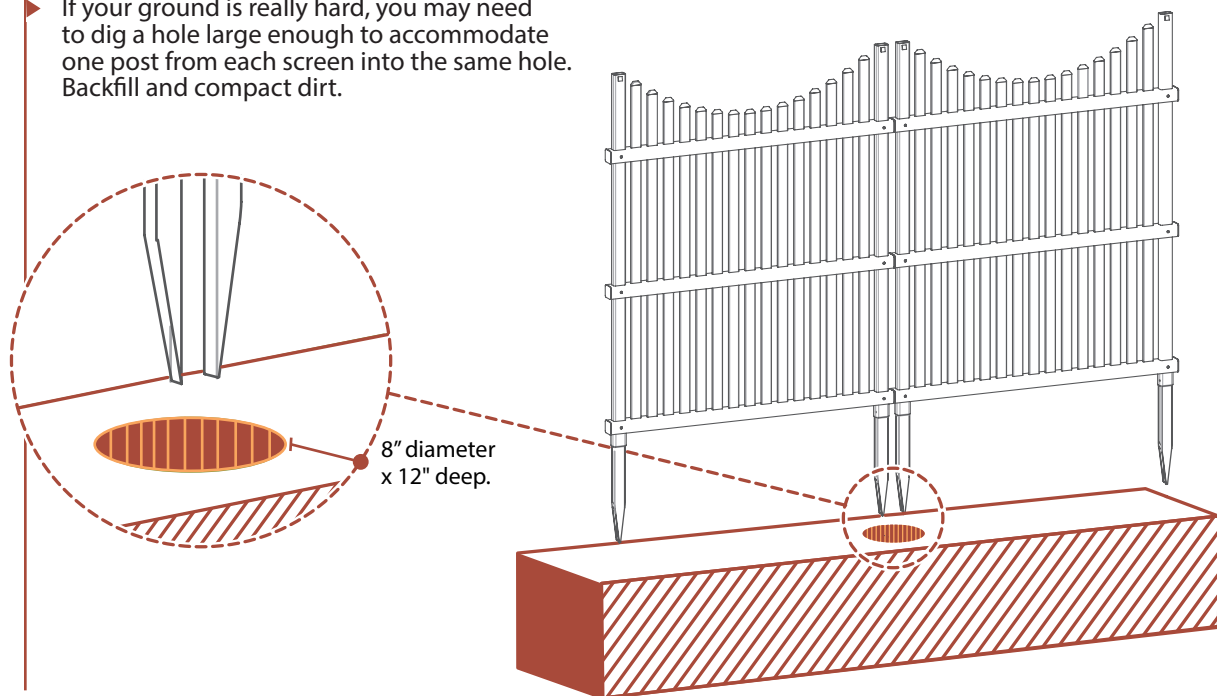

STEP 5: FASTEN JOINER CLIPS

STEP 5.1

- ▶ Fasten screens together by using (2) joiner clips (**H**) and (4) $\frac{3}{4}$ " self-drilling stainless steel screws as illustrated.

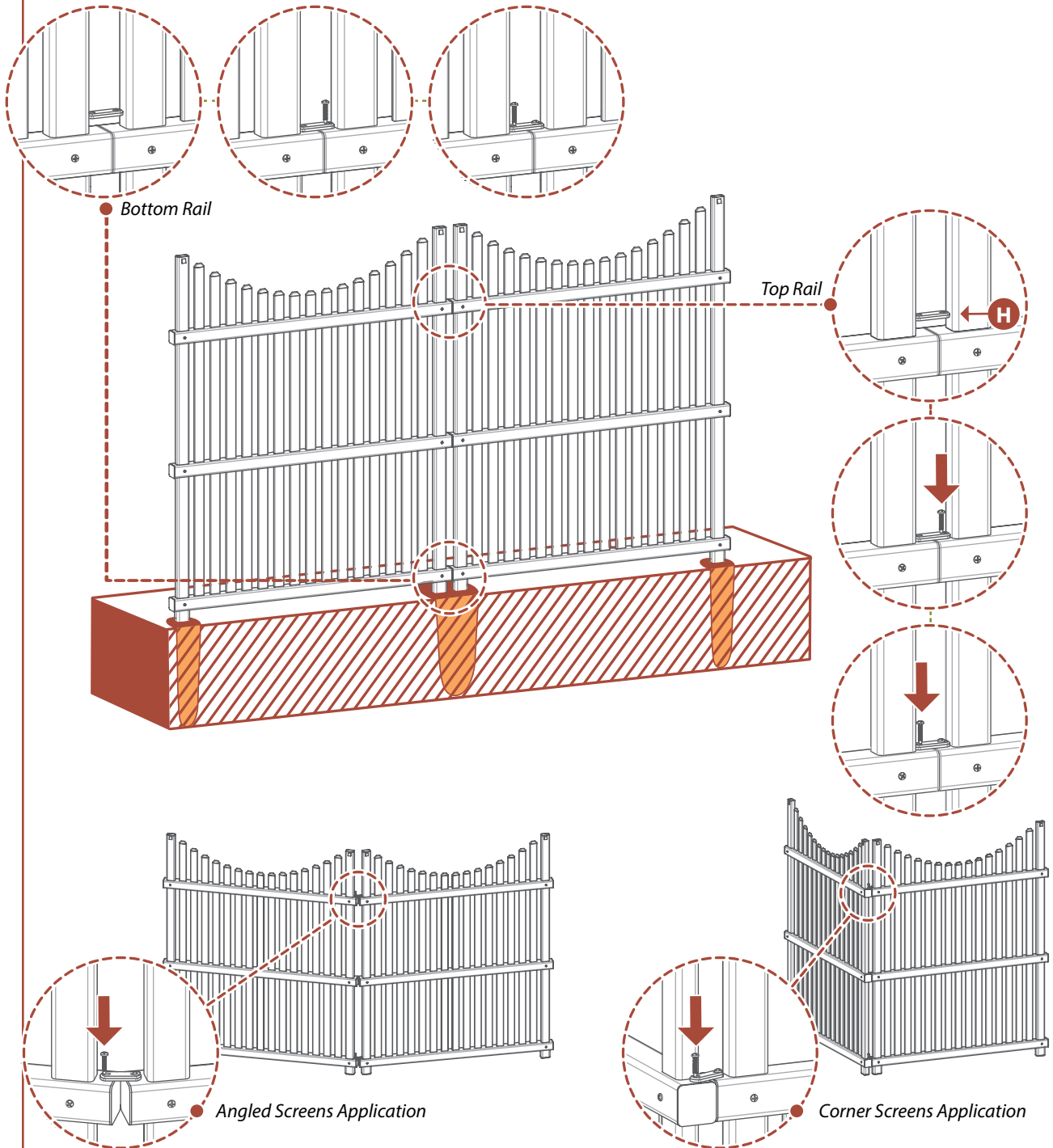

STEP 6: FASTEN POST CAPS

STEP 6.1

- ▶ Push the post Caps (A) down over the posts to lock into place.

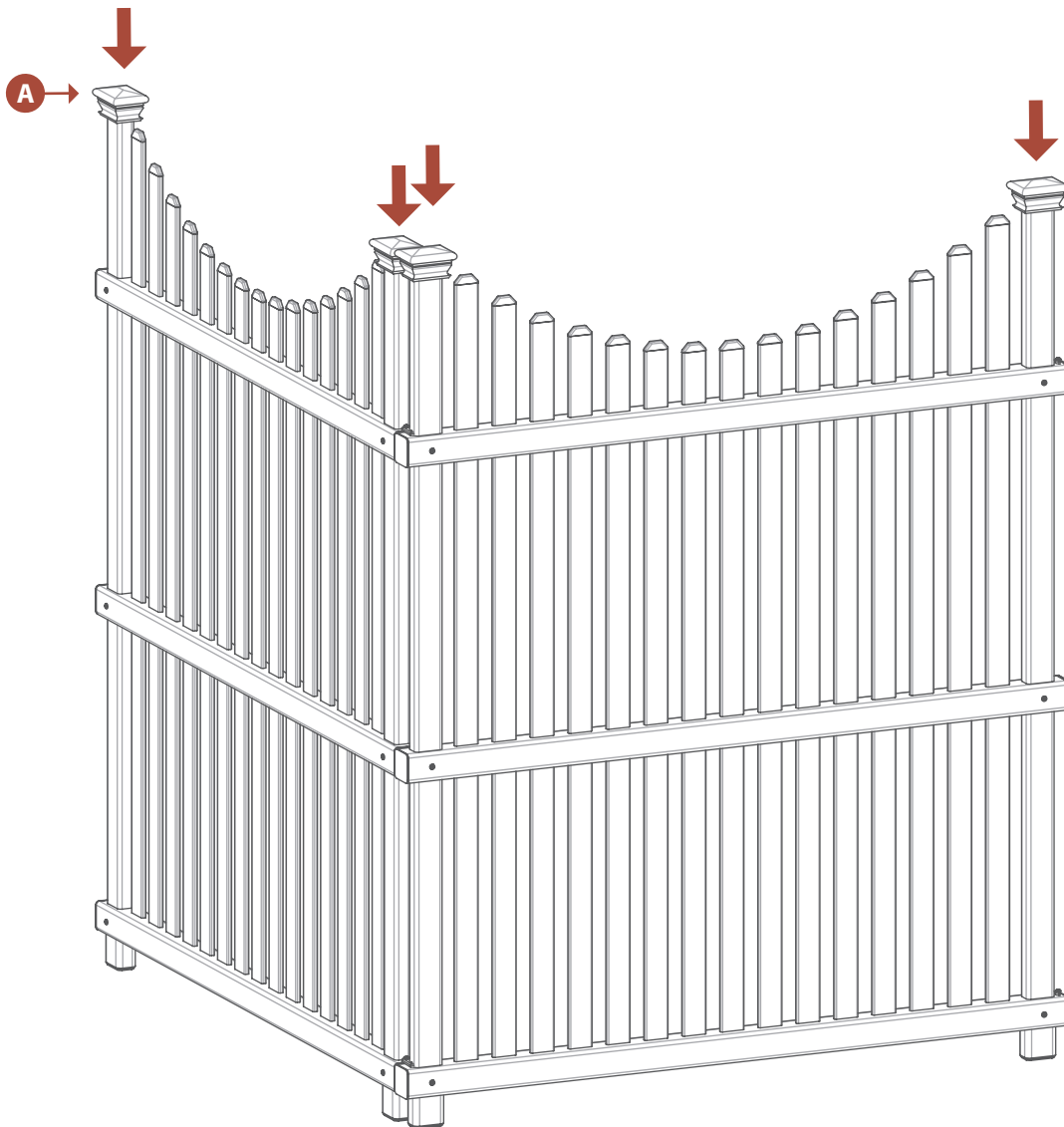

ENCLO

HIDE IT WITH STYLE

www.encloscreens.com

support@encloscreens.com



704-892-5222
877-234-6196



6935 Reames Rd. Ste. K.
Charlotte, NC 28216



ASSEMBLY
INSTRUCTIONS
ZP19036

VER. 090622