

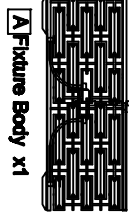







Assembly Instruction Sheet #S-9975P15 For Style 9975P15

Tools Required: Pliers screwdriver, pliers, wire cutters, wire strippers, electrical tape, safety glasses.
Light Source: (4) E12 Candelabra Base Bulbs 60W Maximum(Not Include).
Estimated Assembly Time: 30-40 minute
Preparation: Identify and label all parts before beginning installation. Check package content list and diagrams below to be sure all parts are present. If any parts are missing or damaged, do not attempt to assemble, install, or operate the System. Contact customer service for replacement parts.

Warnings and Cautions
 Turn off electricity at circuit breaker or main fuse box before installation. Consult a licensed electrician if in doubt. These instructions are provided for your safety. It is very important you read them completely before installing the fixture. We strongly recommend that a licensed, professional electrician perform the installation. Disconnect fixture from power source before replacing bulbs. Make sure bulbs are given sufficient time to cool before removal.

Package Contents

 C Boboche x4
 A Fixture Body x1
 D Middle Rod
 B Socket sleeve x4
 E Ceiling Canopy x1
 BB Wire nut
 CC Outlet Box Screw 2pcs
 BB Wire nut
 CC Outlet Box Screw 2pcs

Hardware Contents

PART	DESCRIPTION	QUANTITY
BB	Wire nut	2pcs
CC	Outlet Box Screw	2pcs

STEP 1 - Release Mounting bracket from Ceiling Canopy.

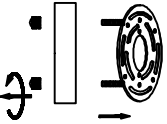

Figure 1

STEP 2 - Install Rods, Ceiling Canopy to Fixture Body.

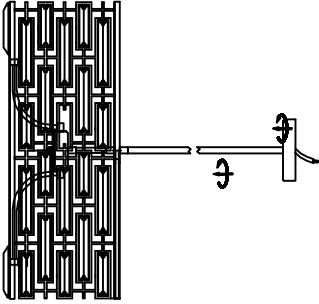

Figure 2

STEP 3 - Attach Mounting bracket to Outlet Box

Pass the supply wires through the Mounting bracket (EE). Attach the Mounting bracket (EE) to the Outlet Box with the head of the Green Ground Screw facing you. Secure it with Outlet Box Screws (CC). Tighten until snug.

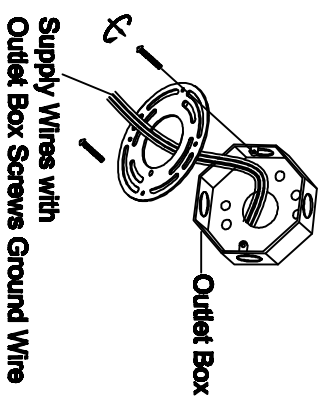

Figure 3

STEP 5 - Install Ceiling Canopy to Ceiling

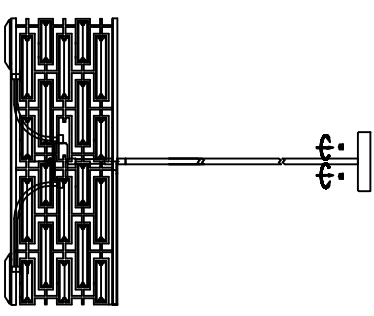

Figure 5

STEP 4 - Wire Connections

Use standard wire connectors to make all wire connections. Twist connectors until wires are tightly joined together. Wrap each connection with approved electrical tape and carefully stuff all the connected wires into the Outlet Box.

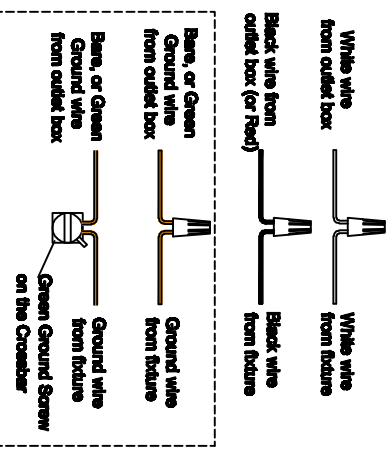

Figure 4

STEP 6 - Install Bobochees, Socket sleeve and Bulbs.

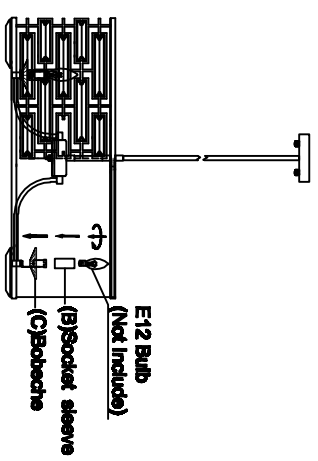

Figure 6