

2-INCH W X 8-INCH D X 8-INCH H LEGACY BRACKET

FRONT
PROFILE

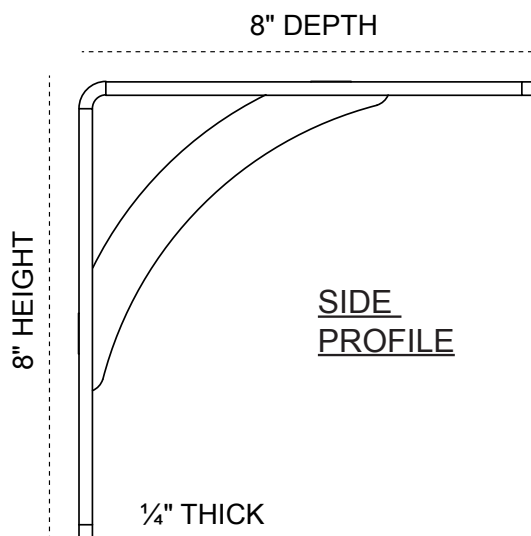
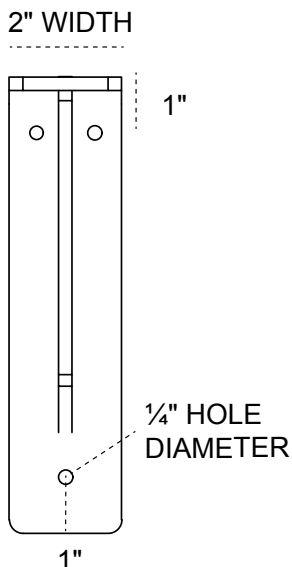

SIDE
PROFILE

BACK

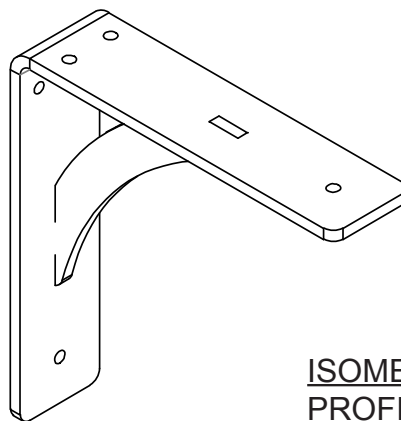
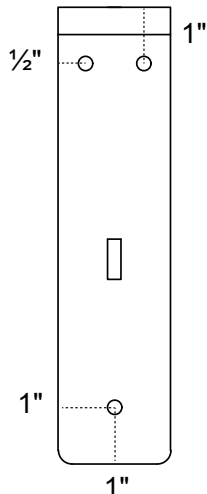

ISOMETRIC
PROFILE

HEAVY-DUTY 1/4" THICK

AVAILABLE IN:
STAINLESS STEEL
ZINC PLATED STEEL
POWDER COATED BLACK

BKTM02X08X08LESS
BKTM02X08X08LECRS
BKTM02X08X08LEPBL

P:866.607.0453 | F: 866.591.3143
2300 W. Main St. | Clarksville, TX 75426
sales@ekenamillwork.com | www.ekenamillwork.com



EKENA
MILLWORK