

FREESTANDING INSTALLATION

Note: If you purchased a brushed nickel trim kit, it must be installed before installing the bathtub (brushed nickel trim not available on all models).

Warning: Due to the rough handling during shipping or on the job site, do not install this product until a thorough inspection and water test has been completed.

Check bathtub for correct model and size. Carefully inspect the tub for any damage (i.e., chips, scratches, cracks). If at any point during the pre-installation inspection and water test, you discover a problem with the bathtub or piping system, DO NOT INSTALL the unit and contact us immediately.

All pre installed parts must be checked and retightened before installation.

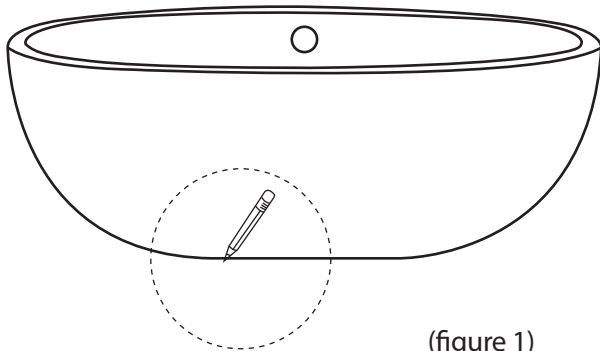

(figure 1)

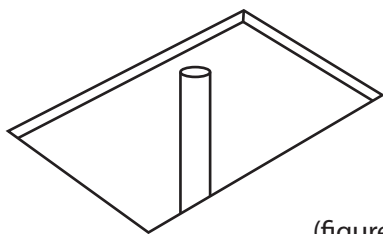

(figure 2)

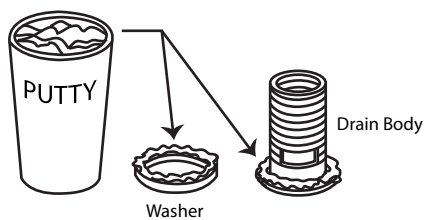

(figure 3)

PREPARATION

1. Clean, level, and prepare the floor for installation.
2. Place the unit in the exact installed position on the floor and trace the outline of the bath with a pencil or any erasable marking (figure 1).
3. Determine the location of the drain pipe, on the floor by taking measurements of the drain and waste location underneath the unit (figure 2).

Note: Drain, waste locations, and trim options vary by model.

4. Using a blanket, cardboard, or other clean protective surface, turn the unit on its side so that the unit is properly supported during drain installation.
5. Clean the drain hole area in preparation of setting the drain. The area should be dry and free of any debris.

INSTALL DRAIN HARDWARE

6. Apply a bead of clear silicone or plumbers putty around the Drain Body and pass it through the drain hole (figure 3).

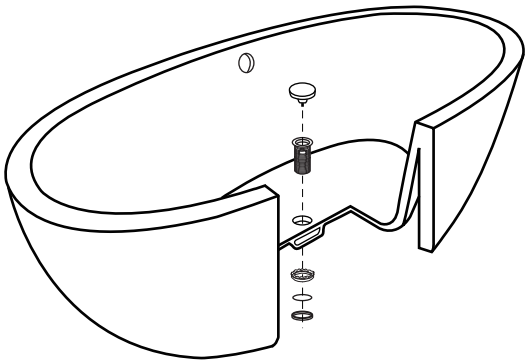

(figure 4)

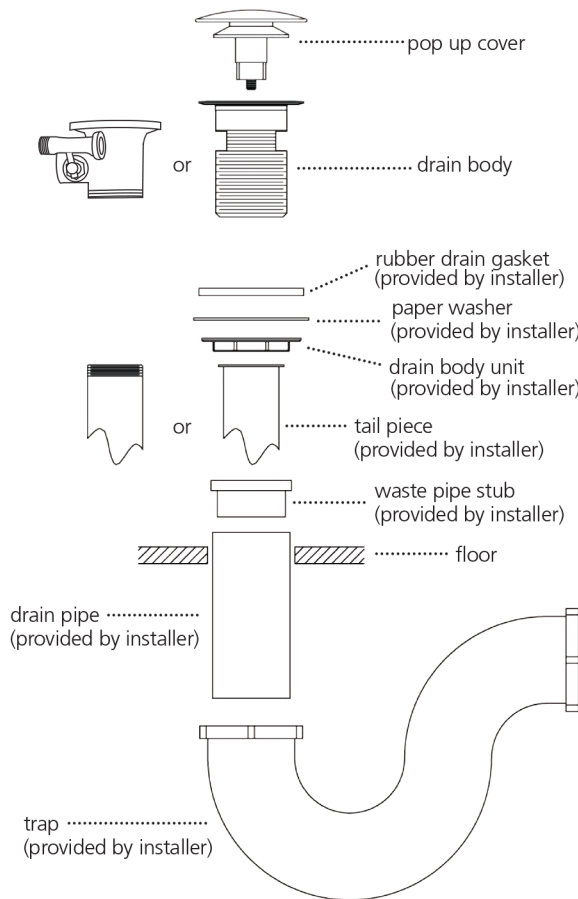

(figure 5)

7. Apply plumbers putty to the Washer and slide it over the bottom of the Drain Body (figure 3).
8. Slide the paper washer over the drain body.
9. Attach the Drain Body Nut on the Drain Body and tighten until the Nut and Washer have created a seal with the bottom of the bathtub. DO NOT OVERTIGHTEN (figure 4).

PREPARE TAIL PIECE

All parts involved in tail piece installation are provided by the installer.

10. Drain waste vent must always be installed according to local standard. Verify the placement of the bathtub before drilling the hole for the drain waste vent.
11. Install 1 3/4" tail piece over the drain waste vent. (figure 5).
12. Cut tail piece to desired length (will vary for each installation).
13. Slide tail piece nut over tail piece towards flanged end.
14. Connect tail piece assembly to waste vent.
15. Place flange washer on top of tail piece.

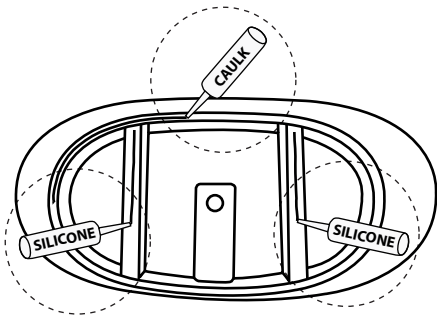

(figure 6)

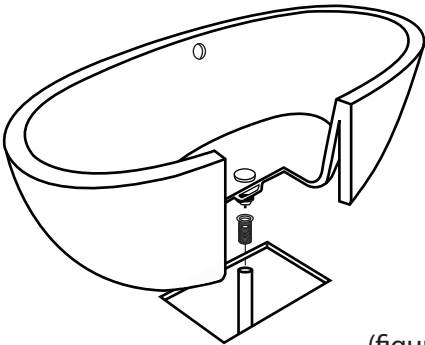

(figure 7)

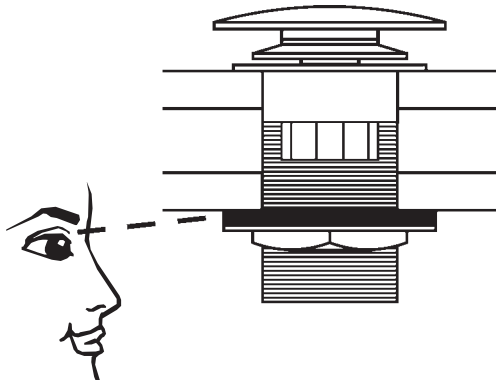

(figure 8)

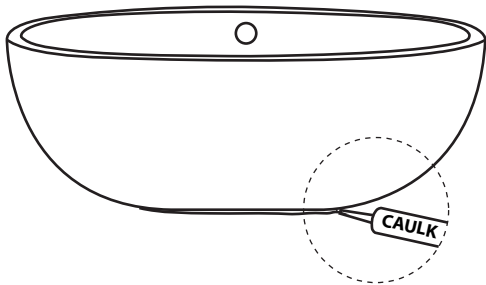

(figure 9)

INSTALL BATHTUB

17. Apply a generous bead of adhesive or silicone to the bottom of the tub supports (figure 6).
18. Then apply a bead of tub and tile caulk around the edge of the base (figure 6).
19. Carefully set tub into position (figure 7) and connect the drain hardware (previously installed). Finish the installation of the tail piece installation.

COMPLETE BATHTUB INSTALLATION

20. Fill the tub with water to the overflow and then drain the tub while inspecting the waste connections below the floor for leaks. Access from below will be necessary for this step (figure 8).
21. With the bathtub now in place, wipe off any excess tub and tile caulk and adhesive where the tub meets the floor.
22. Run a bead of tub and tile caulk around the bottom edge of the bathtub where it meets the floor. Wipe off any excess caulk with a wet cloth (figure 9).