









CARE AND MAINTENANCE

Always use felt pads under all articles to prevent discoloration or softening of the lacquer. Plastic and rubber bases on items can discolor wood. Wipe up spills immediately and avoid common hazards such as hot dishes, harsh solvents and abrasives. Cleaning should be done with a soft lint free cotton cloth dampened with water or furniture polish. On highly used surfaces we recommend applying a quality paste wax which should be used on a regular basis to provide additional protection from scratches and spills. How often you apply the wax depends on how much wear the furniture receives.

NOTICE

- * Please make sure that you have all parts indicated before you begin assembly of this item
- * This item should be assembled on a soft surface to prevent scratching the finish during assembly
- * This item may require periodic tightening

Part List and Hardware List

| PIECE | DESCRIPTION | PICTURE | QUANTITY |
|-------|-------------|---|----------|
| A | TABLE TOP |  | 1X |
| B | LEG |  | 1X |
| C | LEG |  | 1X |
| D | LEG |  | 1X |
| E | LEG |  | 1X |
| F | SHELF |  | 1X |
| G | ALLEN BOLT |  | 4X(10mm) |
| H | ALLEN BOLT |  | 4x(25mm) |
| I | ALLEN KEY |  | 1x |

 **SAFAVIEH**
FURNITURE

Model# AMH6545

Product Dimensions:48"Wx24"Dx17.7"H



PREPARATION

Before beginning assembly of product, make sure all parts are present. Compare parts with package contents list and hardware contents list.

If any part is missing or damaged, do not attempt to assemble the product.

Estimated Assembly Time: 10 minutes.

Tools Required for Assembly (included): ALLEN KEY

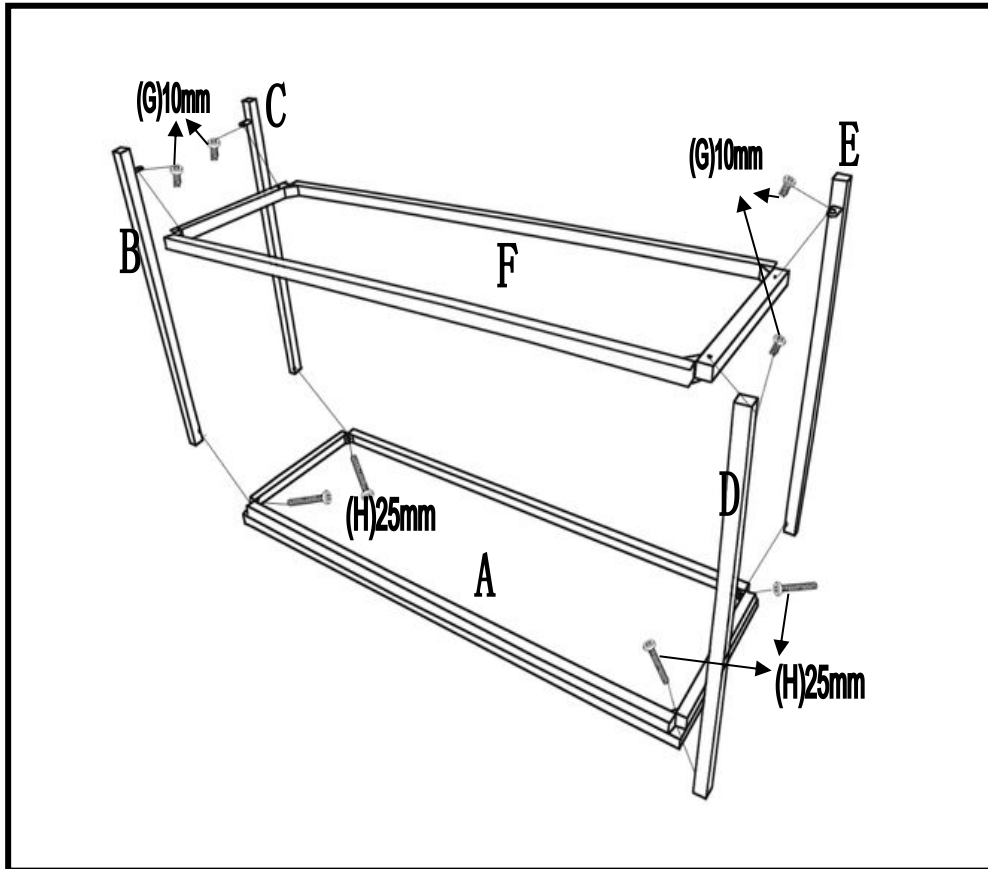

Step 1

Attach the legs (B), (C) (D) (E) to the table top (A), use allen key to tighten the long bolts(H).

Then attach shelf (F) to the leg, use allen key to tighten the short bolts (G).