



# SAFAVIEH

## L I G H T I N G

### Assembly Instruction

**CAUTION:** Read instruction carefully and turn electricity off at main circuit breaker panel before beginning installation.

**ITEM#:LIT4476A / LIT4476B / LIT4476C**



### Care and Cleaning















To clean the outside of the fixture, use a dry or slightly dampened clean cloth(use clean water, never a solvent)to wipe the surface of the fixture.

To clear the inside of the fixture, first disconnect power to the fixture by turning off the circuit breaker or by removing the fuse at the fuse box. Next, use a dry or slightly dampened clean cloth(use clean water, never a solvent) to wipe the interior surface of the fixture

Do not use any cleaners with chemical, solvents or harsh abrasives. Use Only a dry soft cloth to dust or wipe carefully.

Estimated Assembly Time:30 minutes

### Part List and Hardware List

PIECE	DESCRIPTION	PICTURE	QUANTITY	PIECE	DESCRIPTION	PICTURE	QUANTITY
A	Mounting Plate		1X	G	Long Roped Tube		1X
B	Canopy		1X	H	Shade		1X
C	Hanging Loop		1X	I	Finial		1X
D	Canopy Nut		1X	J	Short Roped Tube		3X
E	Chain		1X	K	Wire Nut		3X
E1	Closable link/ cap		2X	L	Mounting Screw		2X
F	Socket Assembly		1X	M	Bulb		3X

# Installation

## Step 1

Unpack all parts from cartons carefully.

Insert one end threaded portion of the Long Roped Tube(G) into the tube underneath the Socket Assembly (F).

Screw the Chain(E) to the loops of the Metal Plate(B) and the Socket Assembly(F) as diagram.

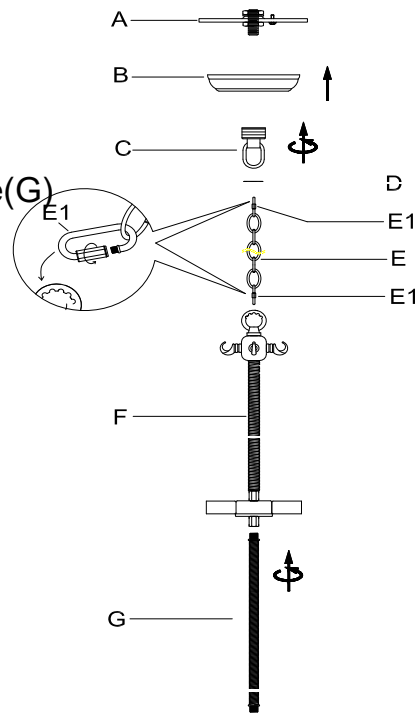

## Step 2

Place the Shade(H) around the Socket Assembly(F) and fix the upper shade by matching the upper loops of the Short Roped Tube(J) to the hooks of the Socket Assembly(F), lower hooks of the Short Roped Tube(J) to the hooks of the Shade(H) as diagram.

Insert the lower end of the Long Roped Tube(G) into the center hole of bottom Shade(H) spider and fix it by turning the Finial(I) clockwise till tight.

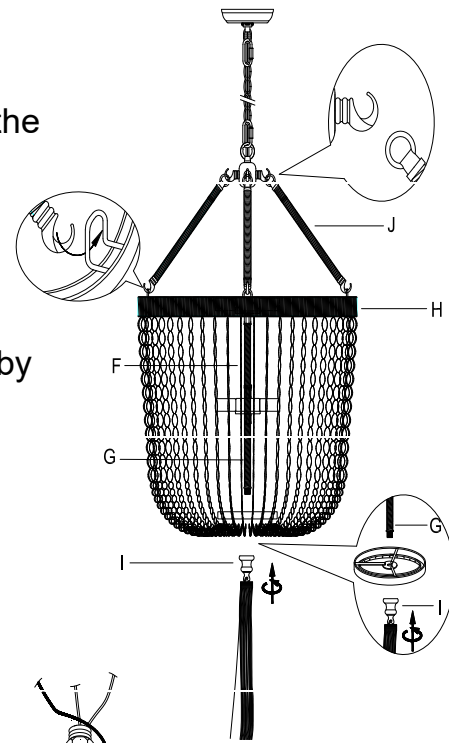

## Step 3

Separate the Mounting Plate(A) from the Canopy (B) by unscrewing the Canopy Nut(D) anti-clockwise.

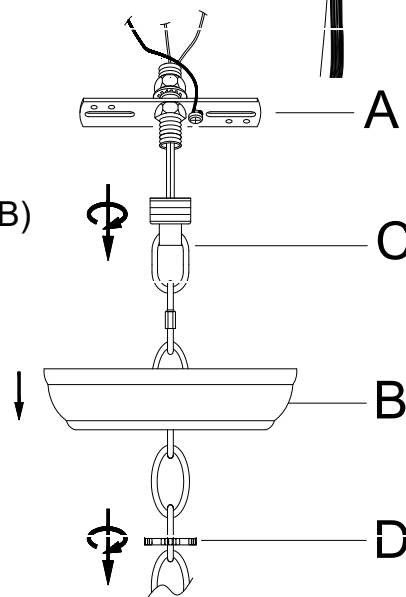

## Step 4 Wire connection

Connect,Hot,Black or Red outlet Supply Wire to:	Connect,Neutral,White Outlet Supply Wire to:
Black	White
*Parallel Cord(round&smooth)	*Parallel Cord(square&ridged)
Clear,Brown,Gold or Black without Tracer(colored stripes)	Clear,Brwn,Gold or Black without Tracer(colored stripes)
Insulated Wire(not green)with copper metal conductor	Insulated Wire(not green)with Silver metal conductor

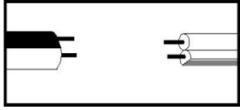

\*Note: When parallel wire(SPTI&SPTII)is used. The neutral wire is square shaped and ridged and the hot wire will be round in shape and smooth.(See illustration on left)



### Grounding Instructions:

- For installation in the United States: Wrap ground wire from outlet box around green ground screw on mounting bracket, no less than 2" from wire end. Tighten ground screw. If fixture is supplied with a ground wire, connect to outlet ground wire with a wire connector.
- For installation in Canada: If fixture is supplied with ground wire, wrap ground wire around green grounding screw on mounting bracket. Tighten ground screw.

## Step 5

Fix the Mounting Plate(A) to the junction box with Mounting Screw (L).

Attach the Canopy(B) to the junction box and fix it by turning the Canopy Nut (D) clockwise.

Insert the bulb (M) into the Socket.

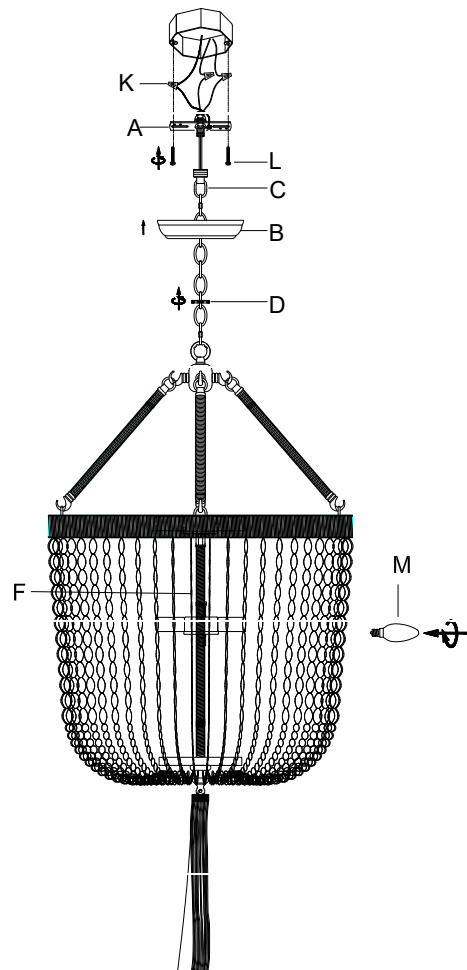

**PLEASE USE TYPE "B" BULB MAX 40-WATT  
OR CFL BULB MAX 13-WATT OR LED MAX 9-WATT  
THERE ARE 3\* LED 4W BULBS IN THE BOX.**

## Step 6

Consult a qualified electrician to ensure correct branch circuit conductor

To prevent the twined rope from loosening, pls follow below steps to insert the Long Roped Tube(G) into the nipple joint of the Socket Assembly(F).

Fig.1

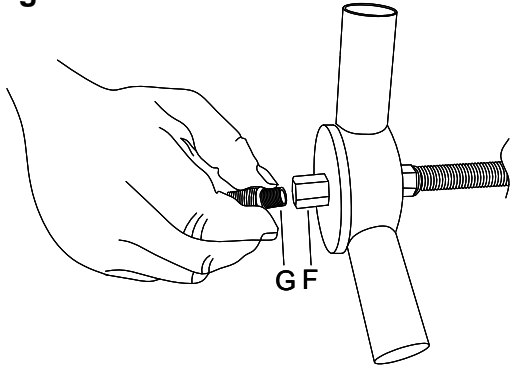

Firstly, squeeze the end of the Long Roped Tube(G) as Fig.1, **not the roped parts as Fig.3**, then insert it into the nipple joint of the Socket Assembly(F) a little.

Fig.2

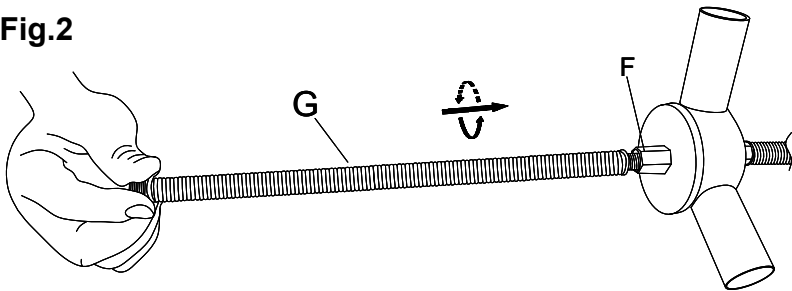

Then clench the end of the Long Roped Tube(G) as Fig.2, **not the roped parts as Fig.3**, insert it into the nipple joint of the Socket Assembly(F) till tight.

Fig.3

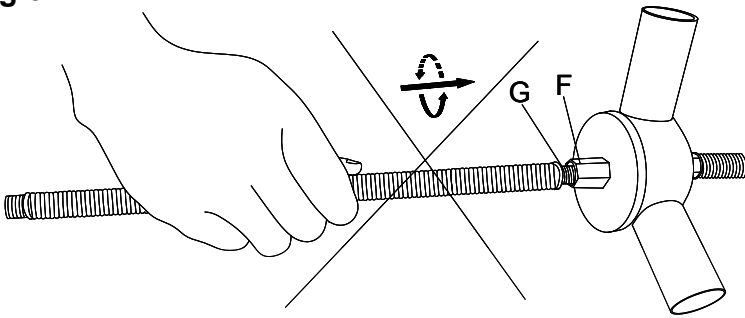

ENJOY YOUR LAMP